

**INSTALLATION
INSTRUCTIONS
for
SLO-SYN[®]
MODEL SS2000MD4
TRANSLATOR/DRIVE**



TABLE OF CONTENTS

	Page
THINGS TO KNOW BEFORE USING THIS EQUIPMENT	3
WARRANTY INFORMATION	3
SECTION 1: INTRODUCTION	3
1.1 Using This Manual.....	3
1.2 Product Features.....	4
SECTION 2: EXPRESS START UP PROCEDURE	5
SECTION 3: INSTALLATION GUIDELINES	6
3.1 Mounting.....	6
3.2 Terminal Locations And Assignments.....	7
SECTION 4: SPECIFICATIONS	11
4.1 Mechanical Specifications.....	11
4.2 Electrical Specifications	11
4.3 Environmental Specifications	11
4.4 Motor Compatibility.....	12
4.5 Current Settings	14
4.6 Step Resolution	14
4.7 Signal Specifications	15
4.8 Indicator Lights.....	18
SECTION 5: TORQUE VERSUS SPEED CHARACTERISTICS	18
5.1 Motor Performance.....	18
5.2 Typical Torque Vs. Speed Curves	19
SECTION 6: TROUBLESHOOTING	30
APPENDIX A: TROUBLESHOOTING ELECTRICAL INTERFERENCE PROBLEMS	31

THINGS TO KNOW BEFORE USING THIS EQUIPMENT

- Only qualified personnel should install or perform servicing procedures on this equipment.
- Before performing any work on the unit, allow at least five minutes for the capacitors to discharge fully.
- Voltage is present on unprotected pins when unit is operational.
- Motors powered by this drive may develop extremely high torque. Be sure to disconnect power to this drive before doing any mechanical work.

CAUTION:

This unit is designed for 24 to 40 Vdc input only (see Section 4.2, Electrical Specifications, Page 7).

WARRANTY INFORMATION

Reconfiguration of the circuit in any fashion not shown in this manual will void the Warranty.

Failure to follow the installation guidelines as described in Section 3 will void the Warranty.

SECTION 1: INTRODUCTION

1.1 USING THIS MANUAL

It is important that you understand how this SLO-SYN SS2000MD4 Translator/Drive is installed and operated before you attempt to use it. **We strongly recommend that you read this manual completely before proceeding with the installation of this unit.**

This manual is an installation and operating guide to the SLO-SYN SS2000MD4 Translator/Drive. Section 1 gives an overview of the Drive and its features. Section 2 describes the steps necessary to place the drive into operation. General wiring guidelines as well as the physical mounting of the unit and connections to the drive portion are covered in Section 3.

Complete specifications, listed in Section 4, provide easily referenced information concerning electrical, mechanical and environmental specifications. The procedure for setting the motor current level is also covered in this section.

- Torque versus speed characteristics with all appropriate SLO-SYN Stepper Motors are given in Section 5. Section 6, Troubleshooting, gives procedures to follow if the Translator/Drive fails to operate properly.

Appendix A provides procedures for troubleshooting electrical interference problems.

1.2 PRODUCT FEATURES

The SLO-SYN SS2000MD4 Translator/Drive is a bipolar, adjustable speed, two-phase PWM drive which uses hybrid power devices. It can be set to operate a step motor in full steps or half steps. The maximum running speed is 3,000 rpm. To reduce the chances of electrical noise problems, the control signals are optically isolated from the drive circuit. Features include:

- Switch selectable current levels of 0.5 through 3.5 amperes
- Full short circuit protection (phase-to-phase and phase-to-ground)
- Undervoltage and transient overvoltage protection
- Efficient thermal design
- Optically isolated inputs
- Windings Off capability
- Switch selectable step resolution
- Compact size
- Sturdy all-aluminum mounting base

SECTION 2: EXPRESS START UP PROCEDURE

The following instructions define the minimum steps necessary to make your **Drive** operational.

CAUTION:

Always disconnect the power to the unit before connecting or disconnecting the motor leads. FAILURE TO DO THIS WILL RESULT IN A SHOCK HAZARD AND MAY DAMAGE THE DRIVE.

Always operate the unit with the Motor and the Drive enclosure GROUNDED. Be sure to twist together the wires for each motor phase as well as those for the dc input. Six twists per foot is a good guideline.

1. Check to see that the motor used is compatible with the drive. Refer to Section 4.4 for a list of compatible motors.
2. Set the correct current level for the motor being used per the instructions in Section 4.5. **Heat sinking may be required to maintain case temperature below +70° C (+158° F).**
3. Select the appropriate step resolution and set the switches as described in Section 4.6.
4. Wire the motor per the "Motor Connections" description in Section 3.2.
5. Connect the power source to the DC input terminal strip. Be sure to follow the instructions for connecting the filter capacitor as described in Section 3.2, under Power Input.

NOTES: If the motor operates erratically, refer to Section 5, "Torque Versus Speed Characteristics".

Clockwise and counterclockwise directions are properly oriented when viewing the motor from the end opposite the mounting flange.

SECTION 3: INSTALLATION GUIDELINES

3.1 MOUNTING

The SLO-SYN Drive is mounted by fastening its mounting brackets to a flat surface as shown in Figure 3.1. If the drive assembly is mounted against a bulkhead, be sure to apply a thin coating of thermal compound between the drive and the mounting surface before fastening the unit in place. Do not use too much thermal compound. It is better to use too little than too much.

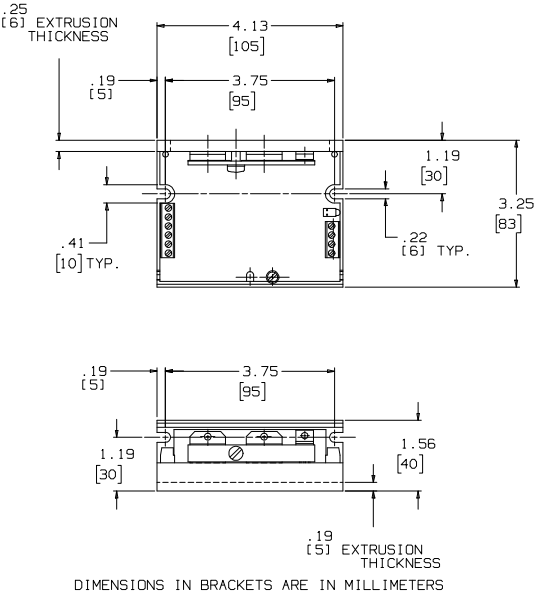

Figure 3.1, Mounting Diagram

NOTE: Case temperature must not exceed +70° C (+158° F).

When selecting a mounting location, it is important to leave at least two inches (51mm) of space around the top, bottom and sides of the unit to allow proper airflow for cooling.

It is also important to keep the drive away from obvious noise sources. If possible, locate the drive in its own metal enclosure to shield it and its wiring from electrical noise sources. If this cannot be done, keep the drive at least three feet from any noise sources.

3.2 TERMINAL LOCATIONS AND ASSIGNMENTS

Figure 3.2 shows the terminal locations for the SLO-SYN SS2000MD4 Translator/Drive.



I/O Connector (J2)

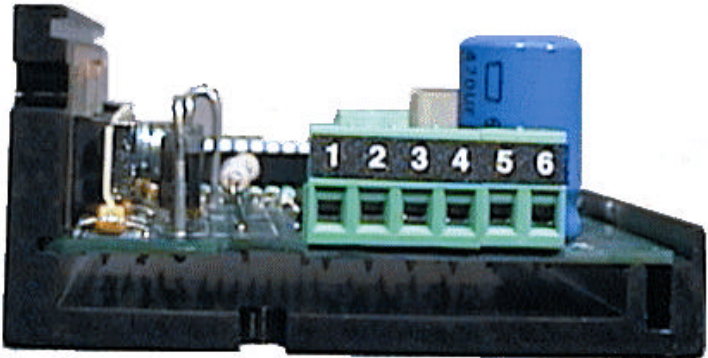

Motor And Power Supply Connector (J1)

Figure 3.2, Terminal Locations

MOTOR CONNECTIONS

All motor connections are made via the 6-terminal strip (J1). Terminal assignments are given below. Motor connections are shown in Figure 3.3.

<u>J1 Pin</u>	<u>Assignment</u>
1	M1 (Phase A+)
2	M3 (Phase A-)
3	M4 (Phase B+)
4	M5 (Phase B-)

NOTE: Motor phase A is M1 and M3 and motor phase B is M4 and M5. The motor frame must be grounded.

Cabling from the drive to the motor should be done with a shielded, twisted-pair cable. The wires for each motor phase should be twisted together about six times per foot.

Superior Electric offers the following motor cable configurations. These cables have unterminated leads on both ends.

Length	Part Number
10 ft (3 m)	216022-031
25 ft (7.6 m)	216022-032
50 ft (15.2 m)	216022-033
75 ft (22.8 m)	216022-034

Figure 3.3 shows the possible motor wiring configurations.

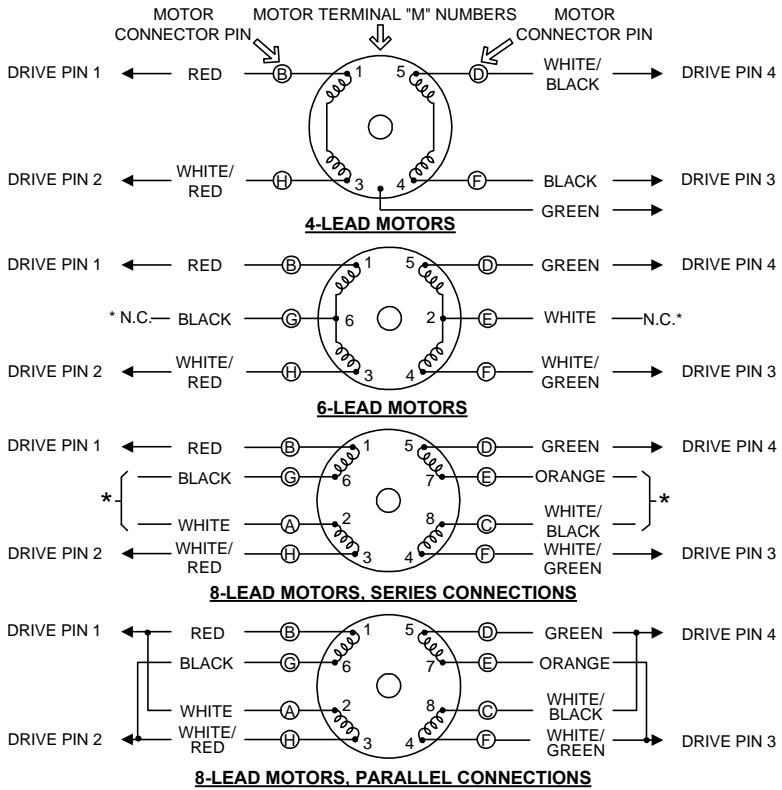

***These leads must be insulated and isolated from other leads or ground.**

Circled letters identify terminals for connector motors, numbers identify those for terminal box motors.

Figure 3.3, Motor Wiring Configurations

POWER INPUT

The dc input power is connected to terminals 5 and 6 of the terminal strip (J1). Terminal 5 [Vm(+)] is the power supply plus (+) connection and pin 6 [Vom(-)] is the power supply minus (-) connection.

An unregulated supply similar to that shown in Figure 3.4 is preferable. If a regulated supply is used, it must be capable of operating with the added filter capacitor. A switching regulated supply may not be suitable for use with this drive. It is important that the capacitor (C1) be connected within three feet (0.9 meter) of the input terminals. The capacitor must be of the correct value and have the proper current and voltage parameters (see list of components on page 7).

It is recommended that the power supply leads be twisted together (6 twists per foot).

NOTE: If the power supply is grounded, it must only be grounded on the negative side or the short circuit protection will not operate properly.

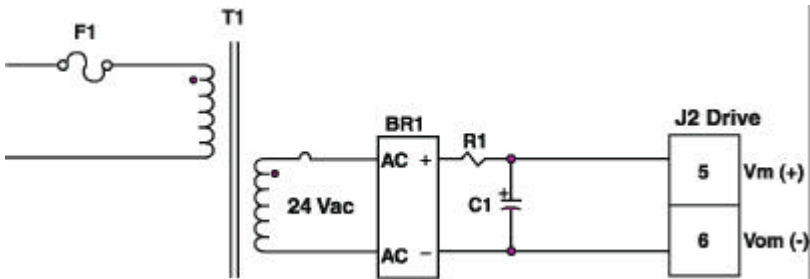

NOTES: The cable between the filter capacitor (C1) and the drive should be twisted (six twists per foot). Maximum wire length is three feet.

Use #16 AWG or larger wire.

Figure 3.4
Typical Power Supply For A Single Drive Application

Components for circuit shown in Figure 3.4

- F1 1.5 ampere time delay, 250 volt
- R1 5 ohm surge limiter, Phillips 2322-654-6158 or equivalent
- T1 130 VA, 24 Vac output
- BR1 General Instrument GBPC3502 or equivalent
- C1 4700 μ f, 5.5 ampere 20 kHz, 63 V rated, United Chemcon 53D472F063HS6 or equivalent

SECTION 4: SPECIFICATIONS

4.1 MECHANICAL SPECIFICATIONS

Size

(Inches)..... 1.56 H x 4.13 W x 3.25 D
(mm) 40 H x 105 W x 83 D

Weight..... 0.6 pounds (272 grams)

4.2 ELECTRICAL SPECIFICATIONS

DC Input Range 24 Vdc min., 40 Vdc max.

DC Current..... see Motor Table

Drive Power Dissipation

(Worst Case) 35 watts

4.3 ENVIRONMENTAL SPECIFICATIONS

Temperature

Operating +32° F to +122° F
(0° C to +50° C) free air ambient, Natural Con-
vection. Maximum heat sink temperature of 158°
F (70° C) must be maintained. Forced-air cooling
may be required.

Storage -40° F to +167° F
..... (-40° C to +75° C)

Humidity 95% max. noncondensing

Altitude 10,000 feet (3048 m) max.

4.4 MOTOR COMPATIBILITY

Motor Types Superior Slo-Syn M and KM Series
M Series Frame Sizes..... M061 (NEMA 23D) through M092 (NEMA 34)
KM series frame sizes..... KML061 (NEMA 23) through
KML093 (NEMA 34)
Number of Connections ... 4, 6, 8
Minimum Inductance..... 0.5 millihenry
Maximum Resistance..... = $0.25 \times V_{dc} \text{ Supply}/I \text{ Setting}$

Example:

$$V_{dc} = 30 \quad I \text{ Setting} = 3.5$$
$$R \text{ max.} = 0.25 \times 30/3.5 = 2.1 \text{ ohms}$$

NOTE: Maximum resistance is total of motor plus cable.

CAUTION: Do not use larger frame size motor than those listed, or the drive may be damaged. If a larger frame size motor must be used, consult the factory for recommendations.

MOTORS FOR USE WITH THE SS2000MD4 TRANSLATOR/DRIVE

Motor	Winding	Conne- ction	Current Setting (Amperes)	Power Supply Current	
				Standstill (Amps. DC)	Maximum (Amps. DC)
M061	08	Series	2.5	1.0	2.0
M061	08	Parallel	3.5	1.0	2.0
M062	09	Series	3.0	1.0	2.5
M062	09	Parallel	3.5	1.0	3.5
M063	09	Series	3.0	1.5	2.0
M063	09	Parallel	3.5	1.0	3.5
M091	09	Series	3.0	1.0	1.5
M091	09	Parallel	3.5	1.0	3.0
M092	09	Series	3.0	1.5	2.0
M092	09	Parallel	3.5	1.0	3.0
KML060FO5	-	-	2.5	1.0	1.5
KML061FO5	-	-	2.5	1.2	1.5
KML061F11	-	-	3.5	1.0	3.0
KML062F07	-	-	3.0	1.0	2.5
KML062F13	-	-	3.5	1.0	4.0
KML063F07	-	-	3.0	1.5	2.0
KML063F13	-	-	3.5	1.0	4.0
KML091F07	-	-	3.0	1.0	2.0
KML091F13	-	-	3.5	1.0	4.0
KML092F07	-	-	3.0	1.5	2.5
KML092F13	-	-	3.5	1.0	4.0
KML093F07	-	-	3.5	1.8	2.5

Power supply currents shown are measured at the output of the rectifier bridge in Figure 3.4.

M061, M062 and M063 motors listed include LS, LE, CS, FC and FD versions. M091 and M092 motors include FC and FD versions with 6 or 8 leads. Motors with windings other than those listed can be used as long as the current ratings listed on the motors are not exceeded.

All KML motors listed have 4 leads.

4.5 CURRENT SETTINGS

The proper current setting for each motor is shown on the individual torque vs. speed curves. Use this current level to obtain the torque shown. Switches 1 through 7 are used to select the current level. Select the desired operating current by setting the appropriate switch to position 1 (ON). The OFF position is labeled "0". Only one switch should be ON. If two or more switches are ON, the one which selects the highest current level will be the active switch. The switch settings are as follows:

<u>Position</u>	<u>Current (amperes)</u>
None	0.5
1	0.75
2	1.0
3	1.5
4	2.0
5	2.5
6	3.0
7	3.5

4.6 STEP RESOLUTION

The number of pulses per revolution is selected using position 8 of the switch described in Section 4.5. The following chart shows the correct switch setting for each available step resolution.

Switch Position 8	Step Resolution	Pulses Per Revolution
0 (off)	Full-Step	200
1 (on)	Half-Step	400

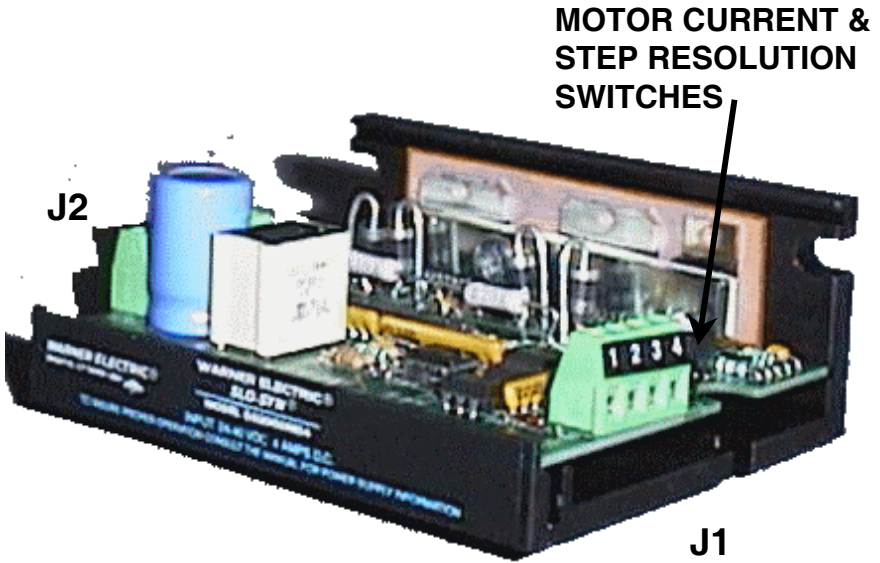

Figure 4.1
Switches For Setting Current Level
And Step Resolution

4.7 SIGNAL SPECIFICATIONS

4.7.1 Terminal Assignments

All connections are made via the 4-pin terminal strip (J2).

J2 Pin	Assignment
1	OPTO
2	PULSE
3	DIR
4	AWO

4.7.2 Signal Descriptions

OPTO Opto-Isolator Supply
User supplied power for the opto-isolators.

PULSE Pulse Input
A low to high transition on this terminal advances the motor one step. The step size is determined by the Step Resolution switch setting.

DIR Direction Input

When this signal is high, motor rotation will be clockwise.
Rotation will be counterclockwise when this signal is low.

Clockwise and counterclockwise directions are properly oriented when viewing the motor from the end opposite the mounting flange.

AWO All Windings Off Input
When this signal is low, AC and DC current to the motor will be zero. **Caution: There will be no holding torque when the AWO signal is low.**

NOTE: If you are using the drive with an MX2000, SS2000I or SS2000I-V control, the READY input and the OPTO input on the control must be jumpered together.

4.7.3 Level Requirements

OPTO

Voltage 4.5 to 6.0 volts dc
Current 16 mA per signal used

Other Signals

Voltage

Low ≤ 0.8 Vdc
 ≥ 0.0 Vdc
High \leq OPTO
 \geq OPTO - 1 volt

Current

Low ≤ 16 mA
High ≤ 0.2 mA

4.7.4 Timing Requirements

PULSE

Max. Frequency 20 kHz
Max. Rise And
Fall Times..... 1 microsecond
Min. Pulse Width.... 25 microseconds

Other Signals

Response Time 25 microseconds

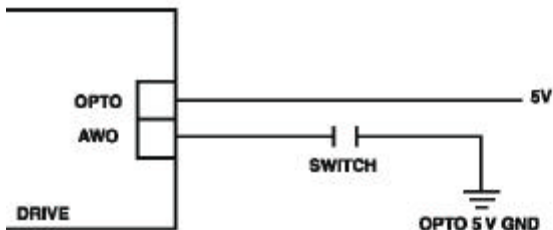
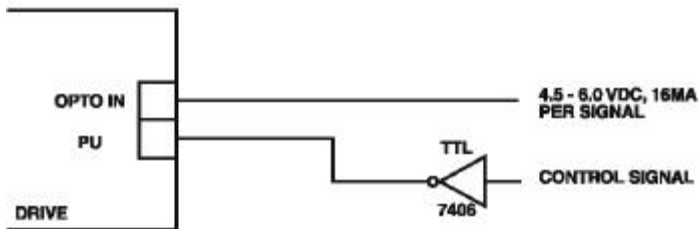
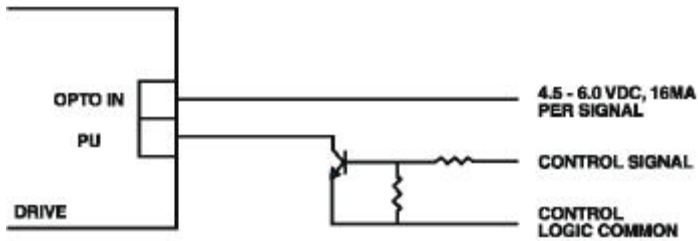
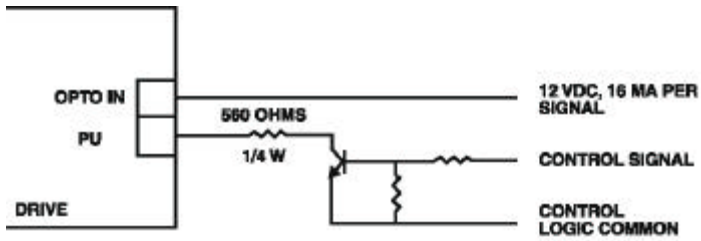

Suggested Methods For Control Interface
Figure 4.2

4.8 INDICATOR LIGHTS

"FAULT" LED, Red

Lights to indicate over current condition. This condition is caused by motor wiring errors or a ground fault.

Recovery from over current condition requires removing and then reapplying the power.

SECTION 5: TORQUE VERSUS SPEED CHARACTERISTICS

5.1 MOTOR PERFORMANCE

All stepper motors exhibit instability at their natural frequency and harmonics of that frequency. Typically, this instability will occur at speeds between 50 and 1000 full steps per second and, depending on the dynamic motor load parameters, can cause excessive velocity modulation or improper positioning. This type of instability is represented by the open area at the low end of each Torque vs. Speed curve.

There are also other instabilities which may cause a loss of torque at stepping rates outside the range of natural resonance frequencies. One such instability is broadly defined as mid-range instability. Usually, the damping of the system and acceleration/deceleration through the resonance areas aid in reducing instability to a level that provides smooth shaft velocity and accurate positioning. If instability does cause unacceptable performance under actual operating conditions, the following techniques can be used to reduce velocity modulation.

- 1) Avoid constant speed operation at the motor's unstable frequencies. Select a base speed that is above the motor's resonant frequencies and adjust acceleration and deceleration to move the motor through unstable regions quickly.
- 2) The motor winding current can be reduced as described in Section 4.5. Lowering the current will reduce torque proportionally. The reduced energy delivered to the motor can decrease velocity modulation.
- 3) Use half stepping to provide smoother operation and reduce the effects of mid range instability. Note that half stepping reduces the shaft speed for a given pulse input rate.

5.2 TYPICAL TORQUE VERSUS SPEED CURVES

NOTE: The test conditions used when obtaining the torque versus speed data are listed in the lower left-hand corner of each curve.

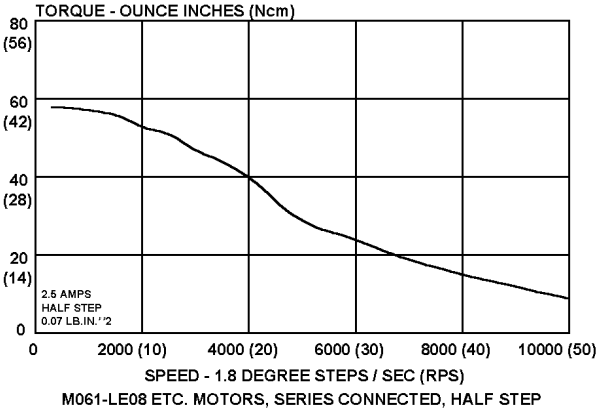
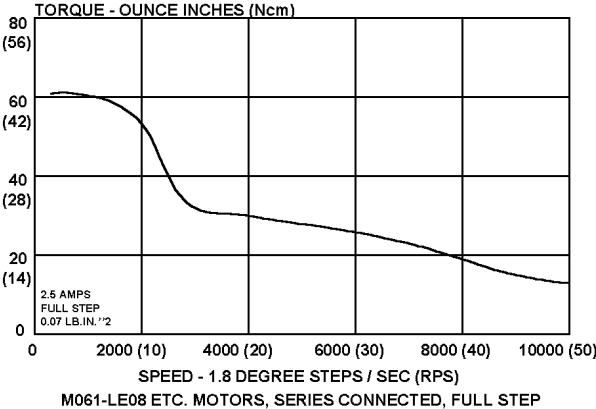

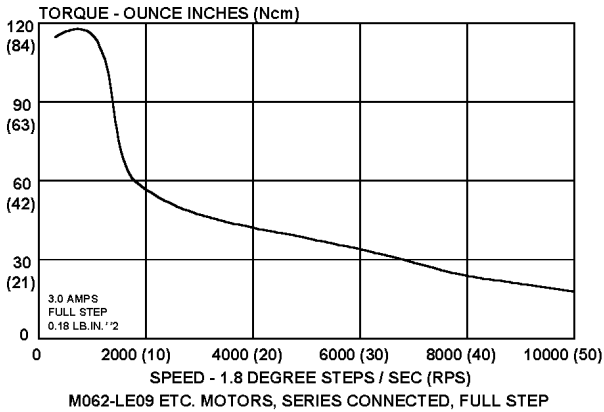
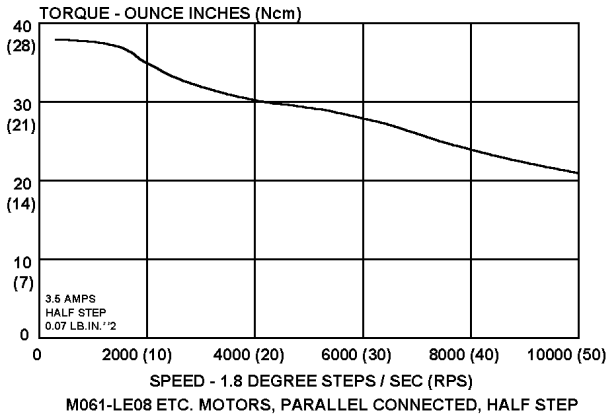
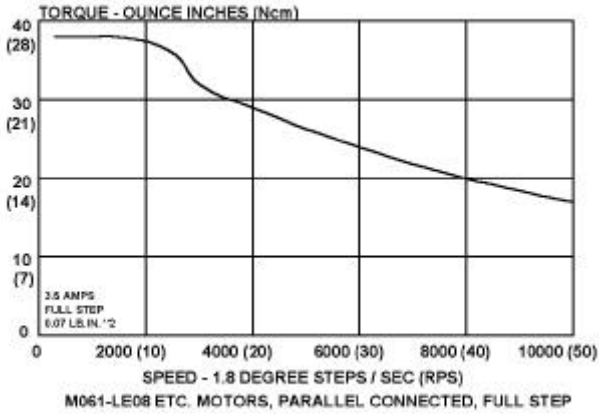

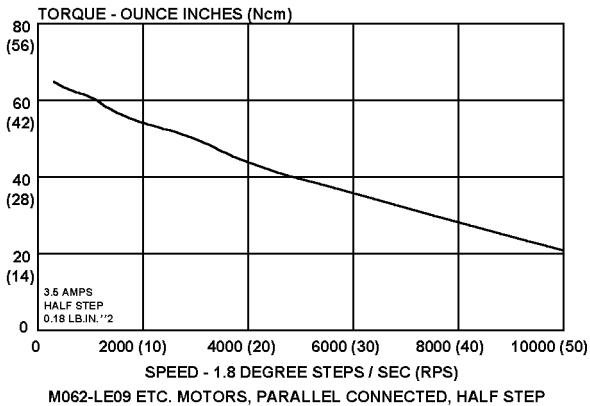
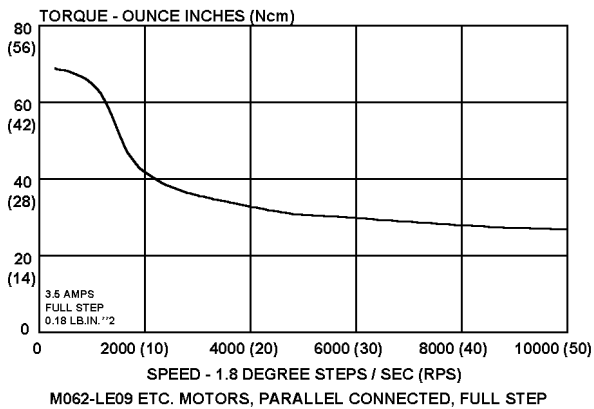
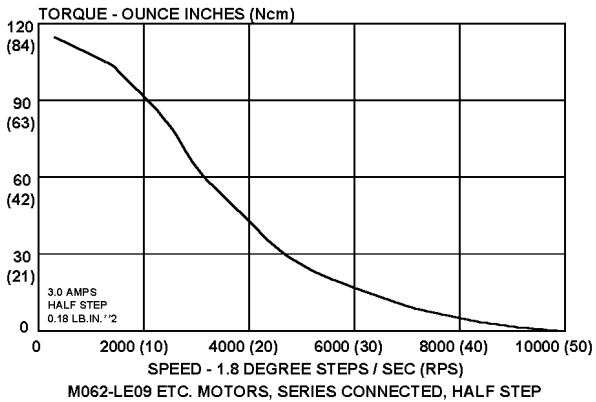

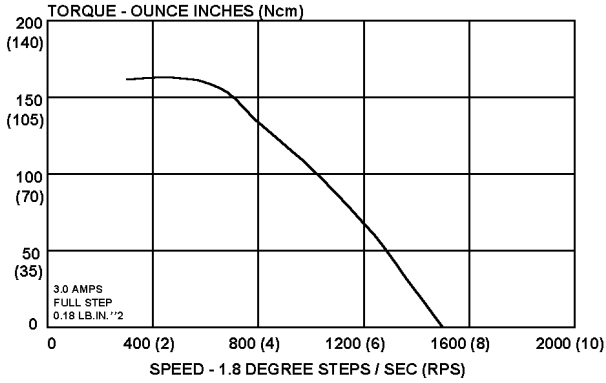

M063-LE09 ETC. MOTORS, SERIES CONNECTED, FULL STEP *

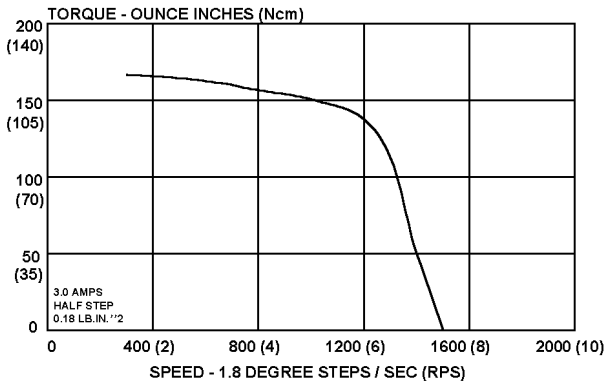

M063-LE09 ETC. MOTORS, SERIES CONNECTED, HALF STEP *

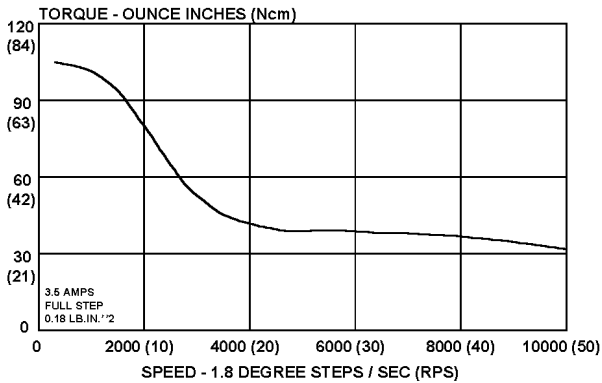

M063-LE09 ETC. MOTORS, PARALLEL CONNECTED, FULL STEP *

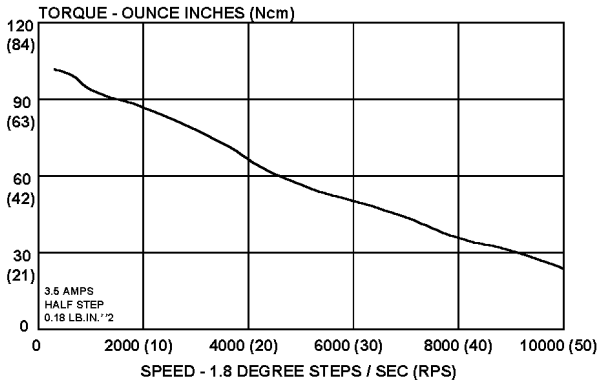

M063-LE09 ETC. MOTORS, PARALLEL CONNECTED, HALF STEP *

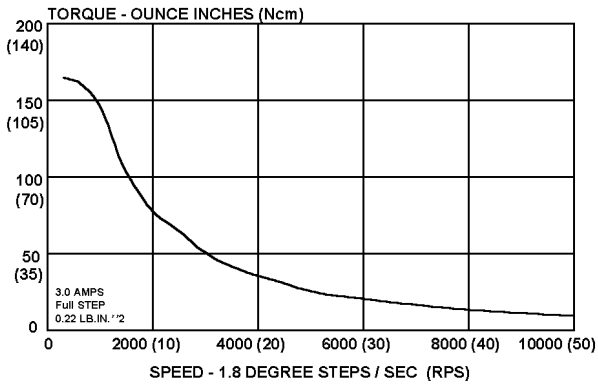

M091-FD8109 MOTOR, SERIES CONNECTED, FULL STEP

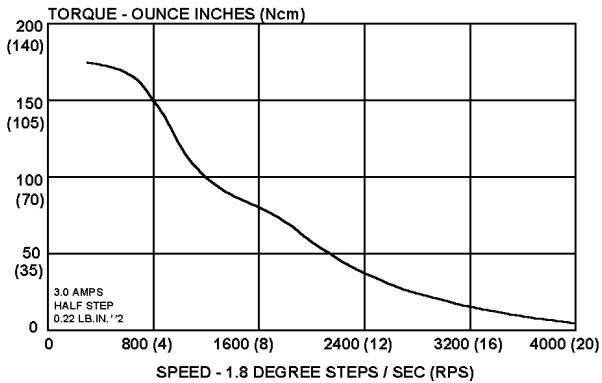

M091-FD8109 MOTOR, SERIES CONNECTED, HALF STEP

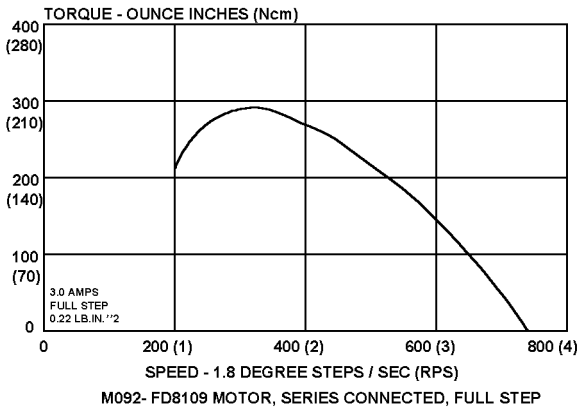
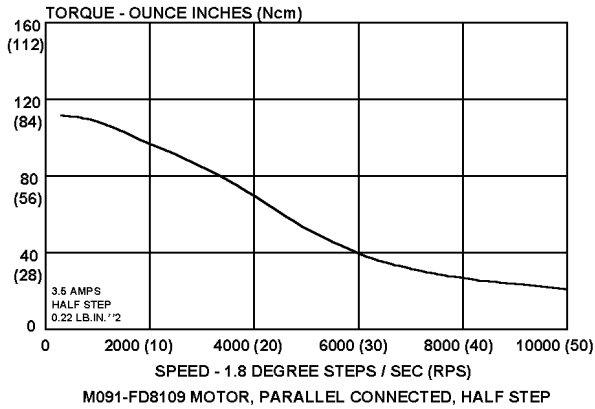
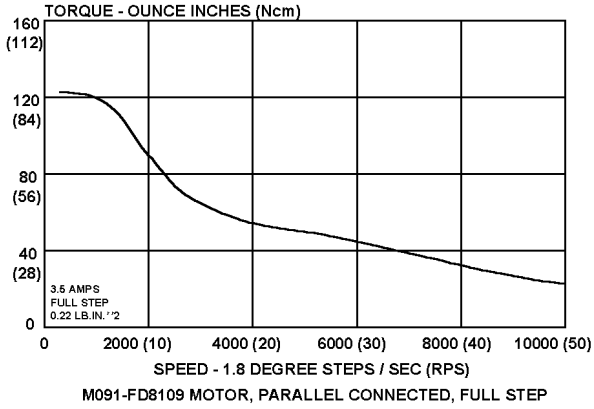

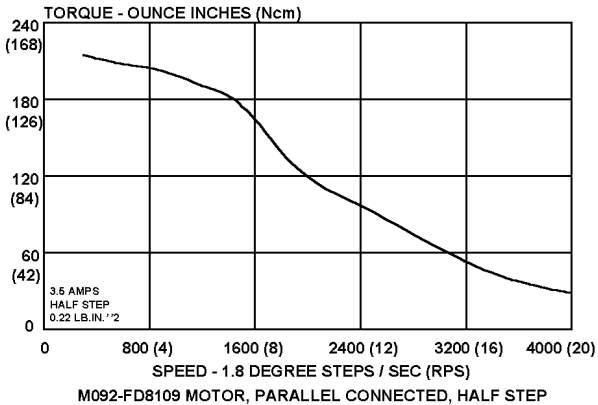
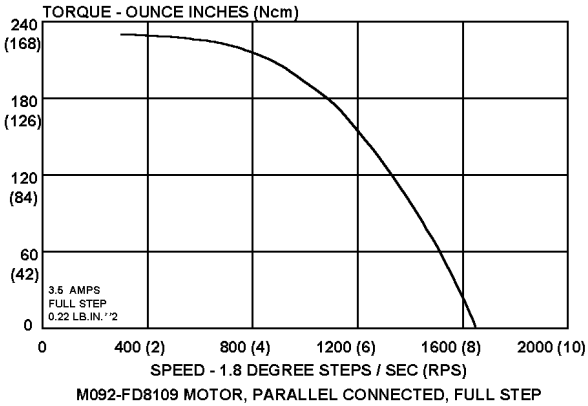
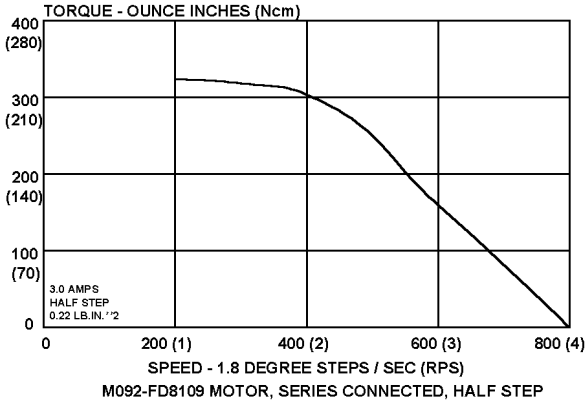

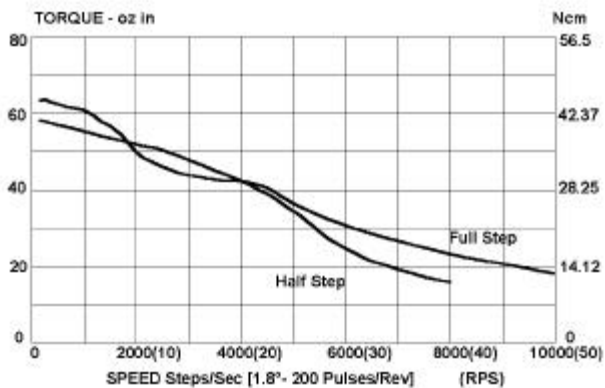

KML060F05, 2.5 Amp

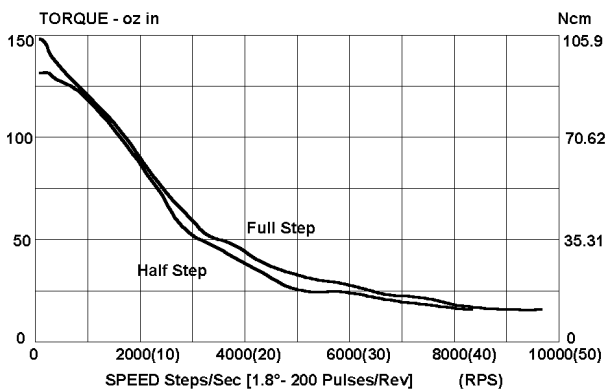

KML061F05, 2.5 Amp

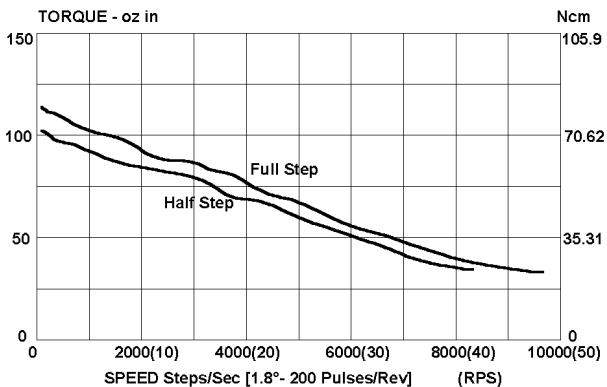

KML061F11, 3.5 Amp

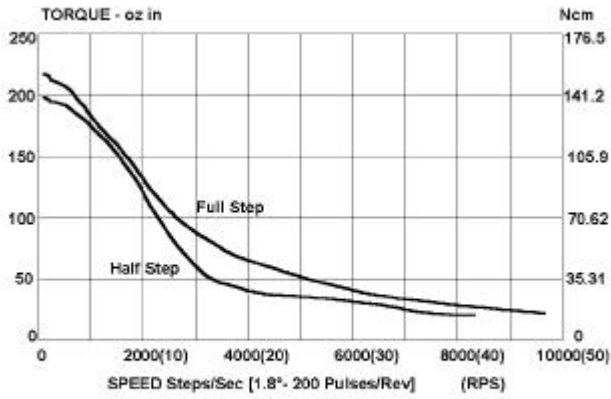

KML062F07, 3.0 Amp

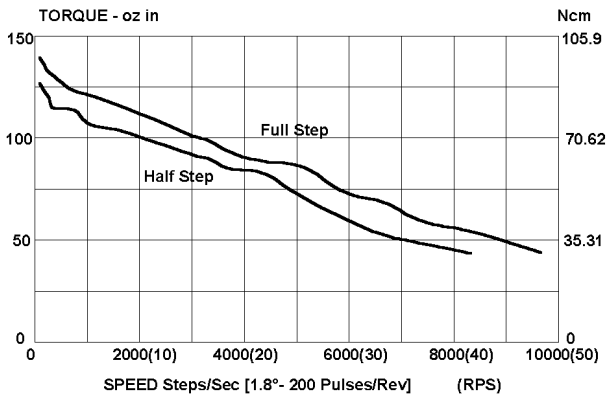

KML062F13, 3.5 Amp

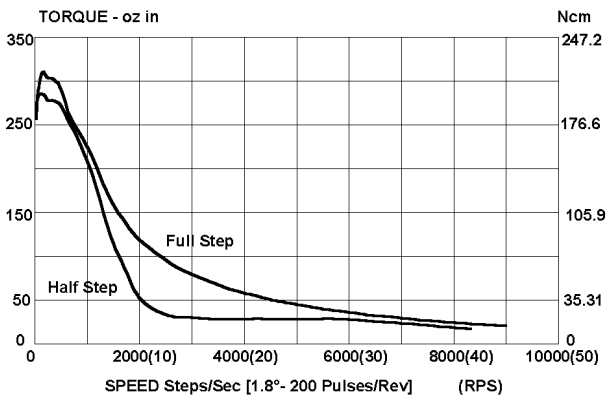

KML063F07, 3.0 Amp

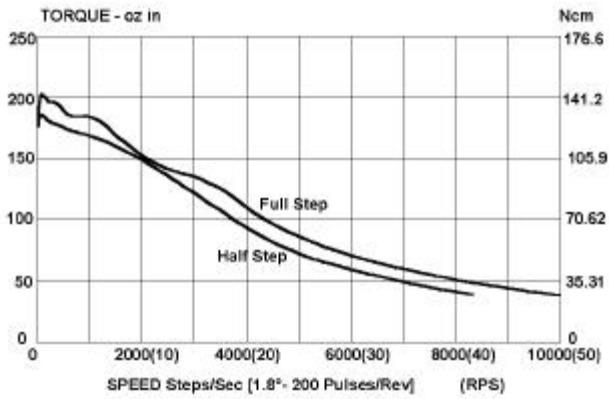

KML063F13, 3.5 Amp

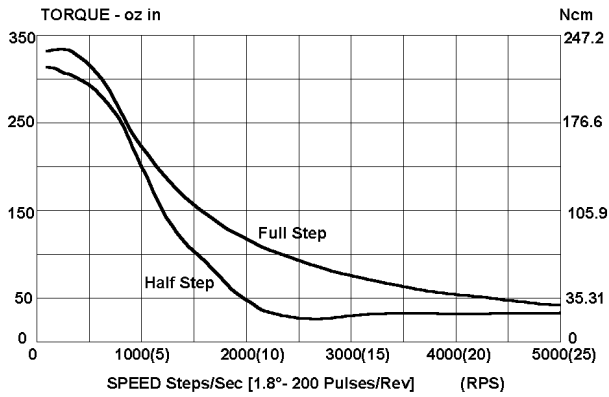

KML091F07, 3.0 Amp

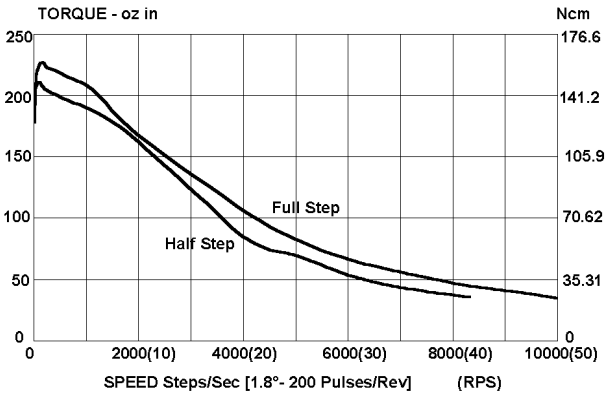

KML091F13, 3.5 Amp

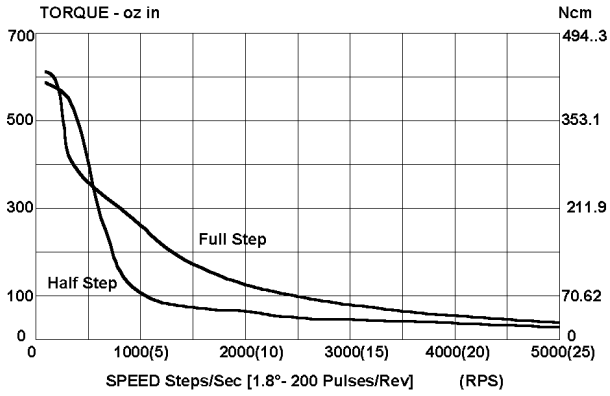

KML092F07, 3.0 Amp

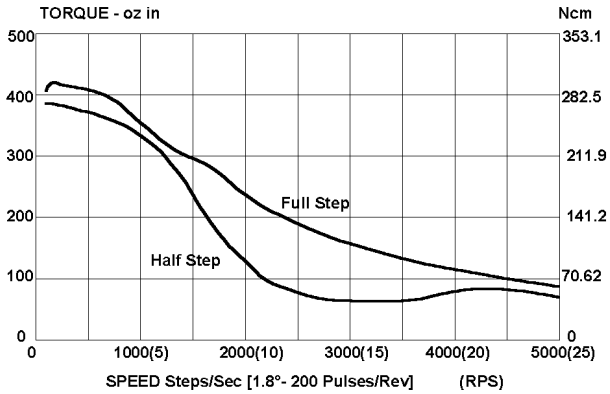

KML092F13, 3.5 Amp

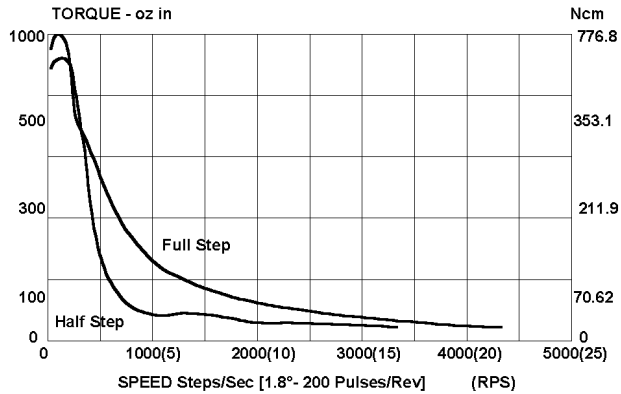

KML093F07, 3.5 Amp

SECTION 6: TROUBLESHOOTING

WARNING:

Motors connected to this drive can develop high torque and large amounts of mechanical energy.

Keep clear of the motor shaft and all parts mechanically linked to the motor shaft.

Turn off all power to the drive before performing work on parts mechanically coupled to the motor.

If installation and operating instructions have been followed carefully, this unit should operate correctly. If the motor fails to step properly, the following checklist will help locate and correct the problem.

In General:

- Check all installation wiring carefully for wiring errors or poor connections.
- Check to see that the proper voltage levels are being supplied to the unit.
- Be sure that the motor is a correct model for use with this unit.

Specifically:

IF MOTOR DIRECTION IS REVERSED, Check For:

Reversed connections to the Motor Connector. Reversing the phase A or the phase B connections will reverse the direction of motor rotation.

IF THE MOTOR MOTION IS ERRATIC, Check For:

Supply voltage out of tolerance.

Improper motion parameters (low speed, acceleration/deceleration, jog speed, home speed and feed rate). Set parameters on controller supplying pulse input to drive.

Filter capacitor missing or too low in value.

IF TORQUE IS LOW, Check For:

All Windings Off active.

Correct current setting.

Improper supply voltage.

IF "FAULT" INDICATOR IS LIT, Check For:

Improper motor wiring

Grounded or shorted wiring to the motor or shorted motor

Improper motor type or incorrect Current Select switch setting

If a malfunction occurs that cannot be corrected by making the preceding checks, contact Superior Electric.

APPENDIX A: TROUBLESHOOTING ELECTRICAL INTERFERENCE PROBLEMS

Electrical interference problems are common with today's computer - based controls, and such problems are often difficult to diagnose and cure. If such a problem occurs with your system, the following checks should be made to locate the cause of the problem.

1. Check the quality of the ac line voltage using an oscilloscope and a line monitor, such as the Superior Electric VMS series. If line voltage problems exist, use appropriate line conditioning, such as line filters or isolation transformers.
2. Be certain proper wiring practices are followed for location, grounding, wiring and relay suppression.
3. Double check the grounding connections to be sure they are good electrical connections and are as short and direct as possible.
4. Try operating the drive with all suspected noise sources switched off. If the drive functions properly, switch the noise sources on again, one at a time, and isolate which ones are causing the interference problems. When a noise source is located, try rerouting wiring, suppressing relays or other measures to eliminate the problem.

Distribution Coast-to-Coast and International

Superior Electric products are available nationwide through an extensive authorized distributor network. These distributors offer literature, technical assistance and a wide range of models off the shelf for fastest possible delivery.

In addition, Superior Electric sales engineers are conveniently located to provide prompt attention to customers' needs. Call the nearest office listed for ordering and application information or for the address of the closest authorized distributor.

IN U.S.A. AND CANADA

383 Middle Street

Bristol, CT 06010

Tel: (860) 585-4500

FAX: 860-589-2136:

Fax: 1 800 766-6366

Customer Service: 1 800 787-3532

Product Application: 1 800 787-3532

Product Literature Request: 1 800 787-3532

Fax: 1 800 766-6366

Website: www.superiorelectric.com

IN EUROPE

Warner Electric (Int.) Inc.

La Pierreire

CH-1029 Villars-Ste-Croix, Switzerland

Tel: 41 021 631 33 55

Fax: 41 021 636 07 04

These products are sold subject to the standard Limitation of Liability and/or Warranty of Superior Electric.

The right to make engineering refinements on all products is reserved. Dimensions and other details are subject to change.



383 Middle Street • Bristol, CT 06010
(860)585-4500 • Fax:(860)589-2136



Manufactured Under an ISO9001
Compliant Manufacturing System