



HYBRID STEP MOTORS

- NEMA 23, 34, 42 frame sizes
- Custom models
- 2 year warranty

P
**PACIFIC
SCIENTIFIC**

HIGH PERFORMANCE MOTORS & DRIVES

November, 2000

ISO
9001

PACIFIC SCIENTIFIC STEPPER MOTORS



A Step Motor Range that Offers You Choices

Pacific Scientific Steppers cover a broad range of possible motion applications. High-quality, innovative design is built into rugged, reliable high-performance motors — from the small to the very powerful. Add a Pacific Scientific indexer or drive for the pinnacle in stepper system performance.

POWERPAC

POWERPAC hybrid step motors offer the highest torque-per-frame size of any motor in the industry.



Available in NEMA 34 and 42 frames, these motors offer holding torques to a staggering 5700 oz-in. Like all Pacific Scientific motors, POWERPAC

steppers are noted for their ruggedness and reliability.

POWERMAX II

POWERMAX II sets the performance standard for NEMA 23 step motors. With up to 253 oz-in. of holding torque, you won't find a more powerful two-inch stepper.

We can build POWERMAX II to your specifications, in the volumes you need, according to your JIT or other delivery schedule.

Conventional Hybrid Step Motors

These high-efficiency, low loss hybrid step motors are available in conventional round-frame configurations.

Our general-purpose hybrid steppers allow you to tailor a motor to your in-plant or OEM specification.

Pacific Scientific Stepper Drives and Indexers Complete the Package

From the modular, flexible 6410 drive module through the fully-programmable powerful motion control of the 5645 indexer/drive, Pacific Scientific stepper drives offer high-performance features with exactly the functionality you need. Ask for more information on the Pac Sci line of stepper drive products today.



TABLE OF CONTENTS

Pacific Scientific maintains a worldwide network of support resources to better serve our customers as a global supplier of motion control technology.

We are dedicated to quality in every component manufactured. We are committed to providing exceptional customer service, unparalleled product quality and reliable delivery with short lead times. Techniques such as data networking and Benchmarking support our commitment to quality and the continuous improvement of operations and products.

Our complete selection of high performance components makes us a single source of supply in many motion control applications.

- brushless servo motors and drives
- adjustable speed motors and drives
- hybrid stepper motors and drives
- multi-axis programming software
- permanent magnet DC motors
- brushless servo motors
- low inertia servo motors
- hybrid stepper motors
- AC synchronous motors

Selection Overview	2
Hybrid Step Motor Technology	5
Application Assistance	6
POWERPAC Hybrid Step Motors-NEMA 34 & 42	10
• Sigmax® technology	
• Standard Hybrid	
POWERMAX II Hybrid Step Motors-NEMA 23	38
• Sigmax® technology	
• Standard hybrid	
• Sigmax Technology, low inertia rotor	
• Standard hybrid, low inertia rotor	
General Purpose Conventional Hybrids-NEMA 23, 34, & 42	54
• Sigmax technology	
• Standard hybrid	
Special Purpose Hybrid Step Motors-NEMA 23	73
• Sigmax® technology, low inertia rotor	
• Standard hybrid, low inertia rotor	
POWERSYNC AC Synchronous Motors-NEMA 34 & 42	82

SELECTION OVERVIEW

Step Motors

GENERAL PURPOSE MOTORS	NEMA 23 Frame	NEMA 34 Frame	NEMA 42 Frame	
	2.3	3.4	4.2	
	Holding Torque Range (oz-in./Nm)			
POWERPAC™ HYBRIDS—				
K Series – Sigmax® technology		570-2790 oz-in. (4.02-19.69 Nm)	1480-5700 oz-in. (10.45-40.23 Nm)	15
N Series – standard hybrid		450-2180 oz-in. (3.18-15.39 Nm)	1150-4365 oz-in. (8.12-30.81 Nm)	15
POWERMAX II® HYBRIDS				38
M Series—Sigmax® technology	89-253 oz-in. (.63-1.79 Nm)			46
P Series—standard hybrid	42-214 oz-in. (.29-1.51 Nm)			45
M “J” Series—Sigmax® technology—low inertia rotor	99-252 oz-in. (.70-1.78 Nm)			48
P “J” Series—standard hybrid—low inertia rotor	79-201 oz-in. (.55-1.42 Nm)			48
CONVENTIONAL HYBRIDS				54
E Series—Sigmax® technology	85-225 oz-in. (.60-1.59 Nm)	223-1300 oz-in. (1.58-9.18 Nm)	957-3958 oz-in. (6.76-27.95 Nm)	58
H Series—standard hybrid	36-156 oz-in. (.25-1.10 Nm)	158-916 oz-in. (1.12-6.47 Nm)	585-2833 oz-in. (4.13-20.00 Nm)	58
SPECIAL PURPOSE HYBRIDS				73
E “J” Series—Sigmax® technology—low inertia rotor	77-196 oz-in. (.54-1.39 Nm)			75
H “J” Series—standard hybrid—low inertia rotor	54-141 oz-in. (.38-.99 Nm)			75
POWERSYNC™ AC SYNCHRONOUS MOTORS				82
SN Series—Synchronous motors		Maximum pull-out torque to 900 oz-in. (6.36 Nm) at 72 RPM	Maximum pull-out torque to 1550 oz-in. (10.95 Nm) at 72 RPM	86

TECHNICAL OVERVIEW

(Con't)

TYPES

POWERPAC K Series	Sigma ^{max} ® hybrid construction
POWERPAC N Series	Standard hybrid construction
POWERMAX II M Series	Sigma ^{max} hybrid construction
POWERMAX II P Series	Standard hybrid construction
General Purpose Conventional hybrid E Series	Sigma ^{max} hybrid construction
General Purpose Conventional hybrid H Series	Standard hybrid construction

ROTOR CONSTRUCTION

POWERPAC N and K Series; POWERSYNC AC Synchronous Motors	Laminated
POWERMAX II M and P Series; Conventional E and H Series with "L" rotor designates	Laminated (high speed efficiency)
POWERMAX II M and P Series; Special purpose E and H Series with "J" rotor designates	Low mass/low inertia (fast start/stop, high acceleration)

WINDINGS

H, J, K, L, M and N	Standard winding designations
T type	Maximum torque at low speed
P type	Maximum torque at high speed
A, B, C, D, E, F, G	Additional standard windings

PHASES 2

FULL STEPS PER REVOLUTION 200

FULL STEP ANGLE 1.8°

ANGULAR ACCURACY

POWERPAC N Series	±3% of one full step, no load non-cumulative
POWERPAC K Series	±1.5% of one full step, no load non-cumulative
POWERMAX II M and M "J"; E and E "J" Series	±1.5% of one full step, no load, non-cumulative
POWERMAX II P and P "J"; H and H "J", H Series	±3% of one full step, no load, non-cumulative

OPERATING TEMPERATURE -20 to 40°C

INSULATION NEMA Class B, 130°C

AGENCY APPROVAL All NEMA 34 and 42 frame motors are
UL recognized; Class B motor
insulation (File E103510)
Construction (File E61960)
CE marked per EN60034-1

INSULATION RESISTANCE 100 Megohms @500V dc and 25°C

TECHNICAL OVERVIEW (CONT)

SEALING POWERPAC N and K Series and Nema 34 and 42 with a "C", "L" or "M" designation in the model number have washdown construction in accordance with NEMA MG1-1.26, part E. With the addition of a shaft seal, they meet IEC (International Electrotechnical Commission) IP65 and are suitable for washdown requirements.

ENCODER OPTIONS

POWERPAC See page 36
POWERMAX II See page 53
Conventional & Special Purpose Hybrids See page 79-80
POWERSYNC See page 93

HYBRID STEP MOTOR TECHNOLOGY

SIGMAX® AND STANDARD HYBRID STEP MOTORS

Here's how Sigmax works.

- Stator mounted rare earth magnets concentrate magnetic flux at desired points between the rotor and stator
- Flux focusing action optimizes flux paths
- Produces higher torque and current utilization is better than a comparably sized standard hybrid

STANDARD HYBRID

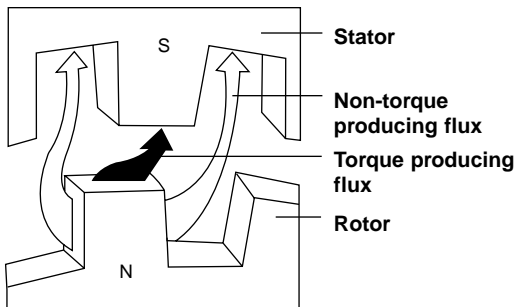

Typical paths of flux transfer in an energized conventional hybrid step motor. Some flux leakage occurs in normal operation.

SIGMAX® TECHNOLOGY

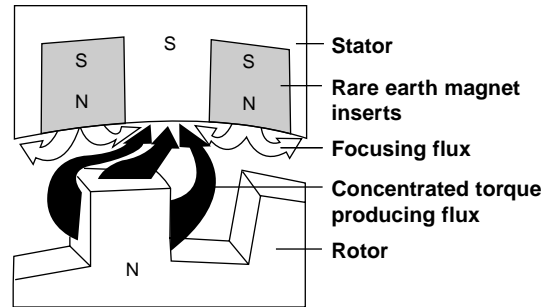

Patented Sigmax® technology* redirects magnetic flux to inhibit leakage and optimize torque production.

* Sigmax® technology is covered by U.S. patents 4,712,028, 4,713,470, 4,763,034 and 4,827,164.

GENERAL PURPOSE MOTORS

These motors offer torque, speed and acceleration characteristics to fulfill commonly encountered applications. All general purpose motors are available in both standard and Sigmax® configurations.

This category includes:

- M and P Series POWERMAX II® hybrid motors, the economical and high performance alternative to conventional NEMA 23 step motors
- H and E Series conventional (round frame) hybrid motors in a full range of frame sizes, with a broad selection of windings to duplicate or exceed the performance of most existing step motors

HIGH TORQUE

The POWERPAC N and K Series, in both NEMA 34 and 42 frames, provide an impressive range of high torque output. See the Ratings and Characteristics for the NEMA 34 frame starting on page 15, followed by torque and acceleration (torque to inertia ratio), and torque linearity comparisons. Performance curves start on page 18. NEMA 42 information starts on page 24.

HIGH ACCELERATION

Both the POWERPAC N and K Series have high torque-to-inertia ratios that provide high acceleration rates to move loads fast. The K Series, which incorporates the flux-focusing Sigmax® technology, provides the highest acceleration rates. Specify the K Series for the most rapid load positioning. See the Ratings and Characteristics for the NEMA 34 frame starting on page 15, followed by torque and acceleration (torque-to-inertia ratio), and torque linearity comparisons. Performance curves start on page 19. NEMA 42 information starts on page 24.

SPECIAL PURPOSE MOTORS

Now and then, you'll run into an application with special acceleration requirements. With PacSci special purpose motors, you may not need to order a customized motor or compromise performance.

All are offered in conventional (round frame) configurations:

- E "J" and H "J" Series motors, in NEMA 23 frame sizes, with hollow, low mass rotors for rapid acceleration

Still don't see it here? Just call. Or fax an application data form (pages 8 and 9) to your Pacific Scientific distributor or the factory. We have an extensive customization capability.

HOLDING TORQUE

Holding torque and rated current are leading specifications for selection in the Ratings and Characteristics tables for all motors. Holding torque is often used as a figure of merit when comparing motors. It specifies the maximum external torque that can be applied to a stopped motor with rated current applied without causing the motor to rotate continuously.

Pacific Scientific hybrid step motors are used with a variety of drivers from many different manufacturers. These drivers have an extremely broad range of voltage and current ratings. It is not practical to show individual torque-speed curve performance given the extensive combinations of driver voltages and currents. Instead, holding torque is shown for reference along with rated current.

TORQUE-SPEED CURVES

As applied voltage and/or current to the motor is changed, motor performance is altered. Figures 1 and 2 show typical torque-speed curves using a bipolar chopper driver.

CURRENT CHANGES VS. PERFORMANCE

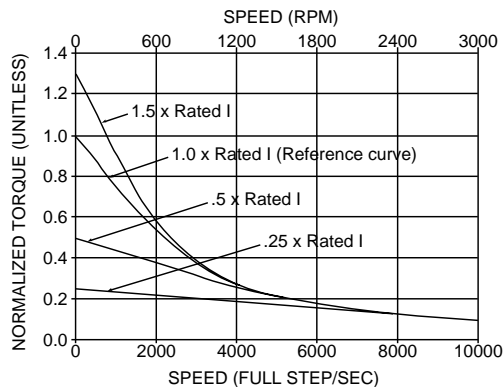

Figure 1

Figure 1 shows the performance of the same motor driven by bipolar chopper drivers with different current ratings. All drivers have the same supply voltage. Note that high speed performance is not appreciably affected by the different current ratings. Low speed running torque, however, varies considerably with changes in the current rating. It is important to understand that when current over the rated current of the motor is applied, the increase in torque will not be proportional to the increased current. Furthermore, applied current levels increasingly higher than rated current will likely result in damage to the motor from demagnetization and/or overheating.

VOLTAGE CHANGES VS. PERFORMANCE

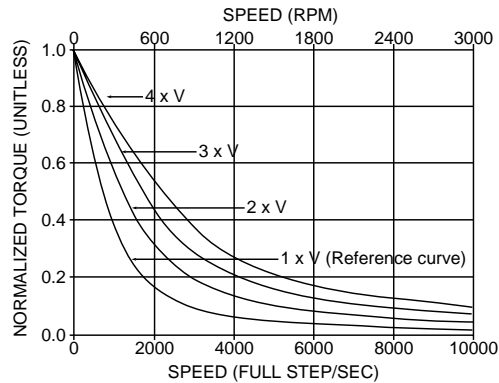

Figure 2

Figure 2 shows the performance of the same motor driven by bipolar chopper drivers with different supply voltage ratings. All drivers have the same current rating. Note that low speed running torque is high and not appreciably affected by supply voltage differences. High speed performance, however, varies considerably with changes in supply voltage. Caution must be exercised when increasing supply voltage. Higher voltages will result in increased motor heating regardless of motor speed.

APPLICATION ENGINEERING

Need help with your motor selection? We make it simple and economical to apply step motors in your designs. Application engineering assistance is only a phone call or FAX away from your Pacific Scientific distributor or the factory. To assist us in providing the optimum motor for your application, please copy and complete the STEP MOTOR APPLICATION DATA form on pages 8 and 9. FAX it to our Application Engineering Department at (815) 226-3148 and we will provide a prompt reply.

Our response includes a comprehensive torque-speed performance curve of the recommended motor at your voltage and current levels.

CUSTOM MOTORS

Even though we offer a broad spectrum of standard motors, we recognize that you might need something special. We routinely design custom windings to provide the application specific characteristics you need. A typical modification such as a special shaft is also a part of this service. Don't hesitate to call us and follow up with the application data form described above.

APPLICATION ASSISTANCE

For a comprehensive analysis of your requirements, just complete and FAX us the STEP MOTOR APPLICATION DATA form on pages 8 and 9 (See APPLICATION ASSISTANCE, previous page). An application engineer will contact you promptly.

ROTARY MOTION—DIRECT DRIVE

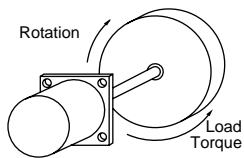

Enhanced hybrid motor torque production, utilizing Sigmamax[®] technology, is ideal for direct drive applications. Benefits include elimination of mechanical gear reduction. Be sure to use a flexible coupling.

ROTARY MOTION—BELT DRIVE

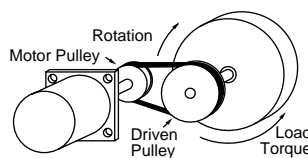

Timing belt or band driven rotary motion is simple to control, efficient and relatively free from backlash.

LINEAR MOTION—LEADSCREW DRIVE

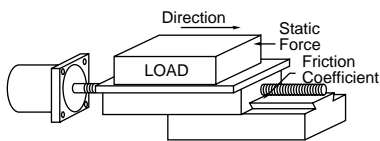

Step motors are well suited to table drives because load remains constant. Leadscrew, rack and pinion, or tangential systems can achieve the desired linear motion and accuracy needed for many applications.

TANGENTIAL MOTION—DIRECT DRIVE

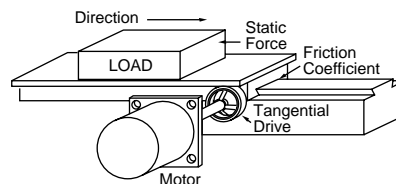

Tangential drives make use of the step motors high torque-to-inertia ratios. In high speed tape and print-head drives, enhanced hybrid motors provide rapid bidirectional accel/decel and critical position control.

SIZING/SELECTION SOFTWARE



VERSION 3.0

Ask us about Optimizer 3.0[™] for Windows[™], our menu driven sizing and selection software package. You'll find out how easy it can be to optimize your motor selection. Request your free copy of Optimizer 3.0 in Windows[™] compatible format on CD-ROM. Inquire at www.pacsci.com

STEP MOTOR APPLICATION DATA

FAX to 815-226-3148
Pacific Scientific
Application Engineering Dept.

Company _____ Date _____

Address _____

City _____ State _____ Zip _____

Name _____ Title _____ Phone _____

Product Description _____

GENERAL

• **APPLICATION DIAGRAM** Draw below or fax separately. Indicate key power transmission details, e.g., pulley and gear ratios, lead screw pitch, efficiencies, nut preload, etc.,. . .all this to size motor and/or control properly.

• **TYPICAL LOAD VELOCITY PROFILE** Using the diagram below as a guide, complete the values for V through T₄. Show worst case for proper sizing.

• **PRODUCTS CURRENTLY USED** List manufacturer and model number _____

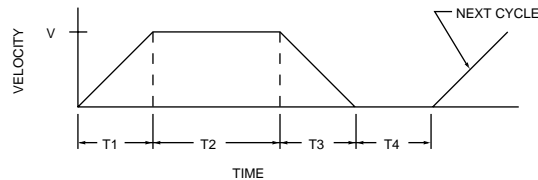

V = Velocity = _____

T₁ = Accel = _____

T₂ = Run = _____

T₃ = Decel = _____

T₄ = Dwell = _____

DRIVE INFORMATION

Bus Voltage _____ Phase Current _____

- Not Specified Yet
 Bipolar
 Unipolar

STATIC REQUIREMENTS

- Accuracy - Accurate to within _____.
 Repeatability - Resolution = _____.
 Holding Torque required = _____ oz in.

SYSTEM LOADING

- Friction loading _____ oz in.
 Total Load Inertia _____ oz in s²
(include coupling and all power transmission inertias)
 Axial Load: Inward Load = _____ lb.
Outward Load = _____ lb.
 Radial Load _____ lb.

COUPLING solid flex bellows

ELECTRICAL CHARACTERISTICS/FEEDBACK

- Inductance = _____ Number of Leads _____
 Resistance/phase = _____ Ω

ENCODER

- Encoder Line Count = _____ ppr
 Line Driver Non-Line Driver

ENVIRONMENT

- Ambient Temp. _____ °Celsius
 Splashproof (IP65)

STEP MOTOR APPLICATION DATA (CONT)

Company _____ Date _____

MOTOR

circle or specify

Note: All motors are 1.8°, 2 Phase.

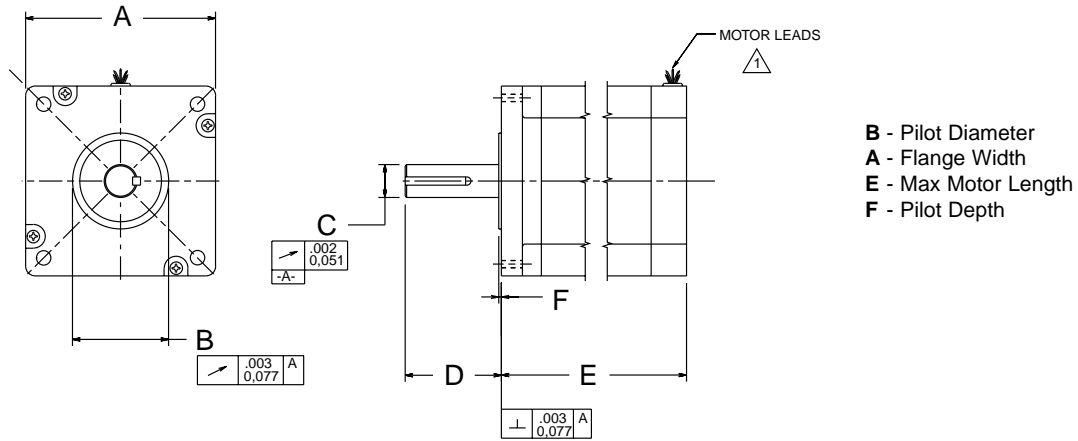

• STANDARD AND SPECIAL FEATURES

Motor model number from catalog _____

Circle whether you want standard or special features. If special, indicate details. Note that special features may result in increased price or leadtime.

• FRONT SHAFT (standard) (special)

D shaft length _____ ± _____ (±.015)*

C shaft dia. _____ ± _____ (+.0000/-0.0005)*

run out Δ _____ (.002 std. ext.)*

— Straight Key per electric motor standards

(standard option) (special)

Key: width _____ height _____

length _____ Other _____

— Flat See Fig. 1 (standard option) (special)

Min. usable length X _____

Dim. over flat Y _____ ± _____ (±.005)*

Corner radius R allowed _____ (±.060)*

Other _____

• REAR END BELL (standard) (special)

mtg. hole B.C. _____ ± _____ (±.010)*

mtg. holes _____

hole pattern _____

other _____

• REAR SHAFT (standard) (special)

shaft length _____ ± _____ (±.040)*

shaft dia. _____ ± _____ (+.0000/-0.0005)*

run out Δ _____ (.002)*

other _____

— Woodruff Key See Fig. 2

(standard option) (special)

ANSI std. key no. _____ (Example 303)

Key location Z _____ ± _____ (±.020)*

Other _____

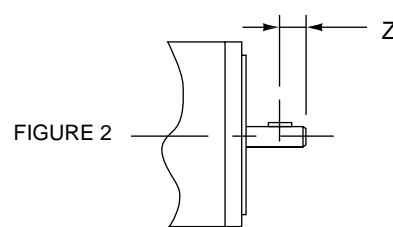
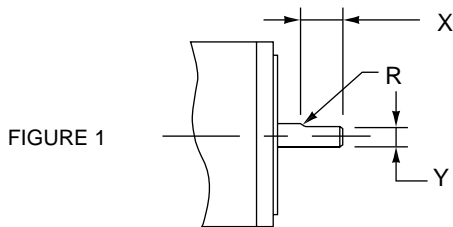

NOTES:

Δ NEMA standard for shaft run out is .002" + .001" for each additional inch of extension past the standard length.

POWERPAC™ HYBRID STEP MOTORS

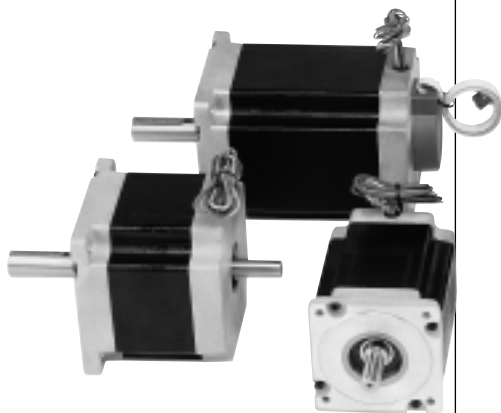

Holding Torques to 5700 oz-in. (356 lb-in.)

New POWERPAC rugged NEMA 34 and 42 frame hybrid steppers provide the highest torques per frame size in the industry. Optimal magnetics in a “housingless” frame combine with a large diameter rotor and new rotor/stator design to produce more torque and provide high acceleration capabilities. This unique design also features low detent torque for smoother microstepping. In addition, POWERPAC runs cooler than comparable size steppers.



N and K Series

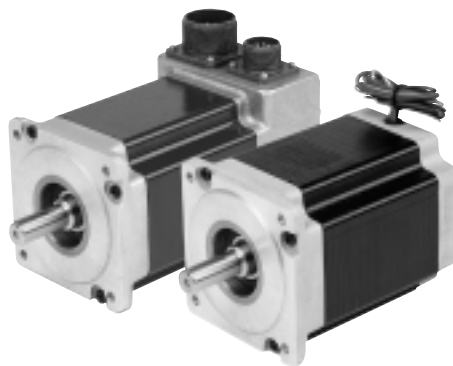

POWERPAC is available in two different designs; the N and K Series. Both provide exceptionally high holding torques. In addition, both have high torque-to-inertia ratios and therefore high acceleration capabilities. The K Series incorporates our patented Sigmax® flux focusing technology and provides 25% more torque than the N Series plus even higher acceleration performance! POWERPAC hybrid steppers meet demanding motion requirements, making them cost effective alternatives to servo motors in applications with moderate speed requirements.

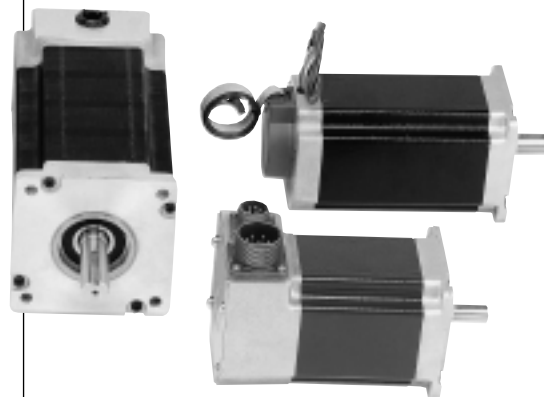

Options

Combinations of standard options are routinely provided to customize the motor for your specific requirements. For termination, select from terminal board connections (via conduit - sealed construction), MS connectors (sealed construction) or flying leads. Rear shaft extensions include one with end bell mounting provisions for a user installed encoder. Factory mounted encoders are installed inside the rear end bell in a sealed construction...or outside, mounted to the rear end bell. Front shaft modifications may be specified. A configuration such as an integral spline is furnished as a special option. Bipolar or unipolar phase sequencing is readily available. In addition to the standard selection of windings, special windings are also provided. Just call us!

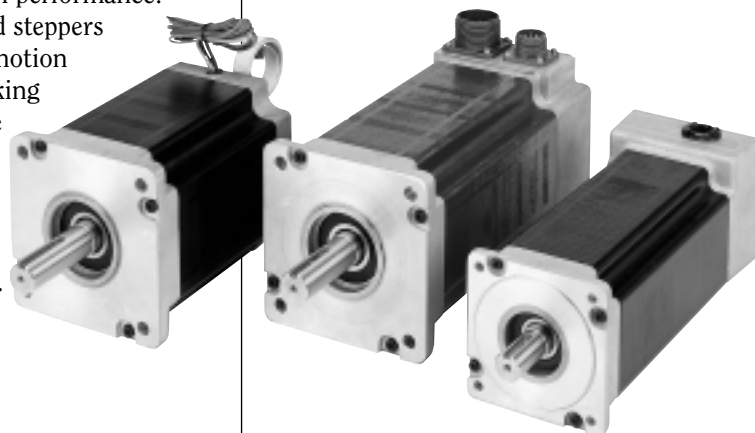

MORE POWER IN A SMALLER PACKAGE - POWERPAC

Sizing and Selection

Our OPTIMIZER™ Version 3.0 for Windows is a powerful motor sizing and selection software program. It provides a simple, time saving method to specify the best POWERPAC motor for your specific requirements. Contact your Pacific Scientific distributor for a copy or visit us on the web at www.pacsci.com

FEATURES

With holding torques to 5700 oz-in. (356 lb-in.), the N and K Series provide the highest torques per frame size in the industry— more than 3 and 5 phase designs.

Improved torque linearity (above rated current) provides high peak torque capability (duty cycle dependent, contact factory)

High torque at moderate speeds

Low detent torque harmonic

K Series uses patented Sigmax® technology to develop 25% more torque than N Series

Runs cooler than comparable steppers using identical drive parameters

Special rotor design for high acceleration

Rugged "housingless" square frame

Sealed per IP65

Outer bearing races won't turn—front locked (in steel insert) and rear held by O-ring

Extensive selection of shaft configurations, terminations, standard and special windings

Two phase design

Optional encoder mounting provisions

BENEFITS

Optimized magnetics provide maximum performance in small envelope, reducing space required for the motor.

Acceleration boost to move loads even faster. Provides more torque for intermittent duty applications

Cost effective alternative to servo motors

Provides smoother microstepping performance

Select from broad performance range to meet your requirement

Longer, more reliable motor life— backed by a two year warranty

Move/position loads fast

Efficient use of volume for optimal magnetic circuit

For splashproof requirements

Long life bearings— also prevents axial shaft movement for encoder applications

Match your requirements

Compatible with most drivers, smoother microstepping, and lower input power required vs. three phase for same torque

Optimizes control scheme

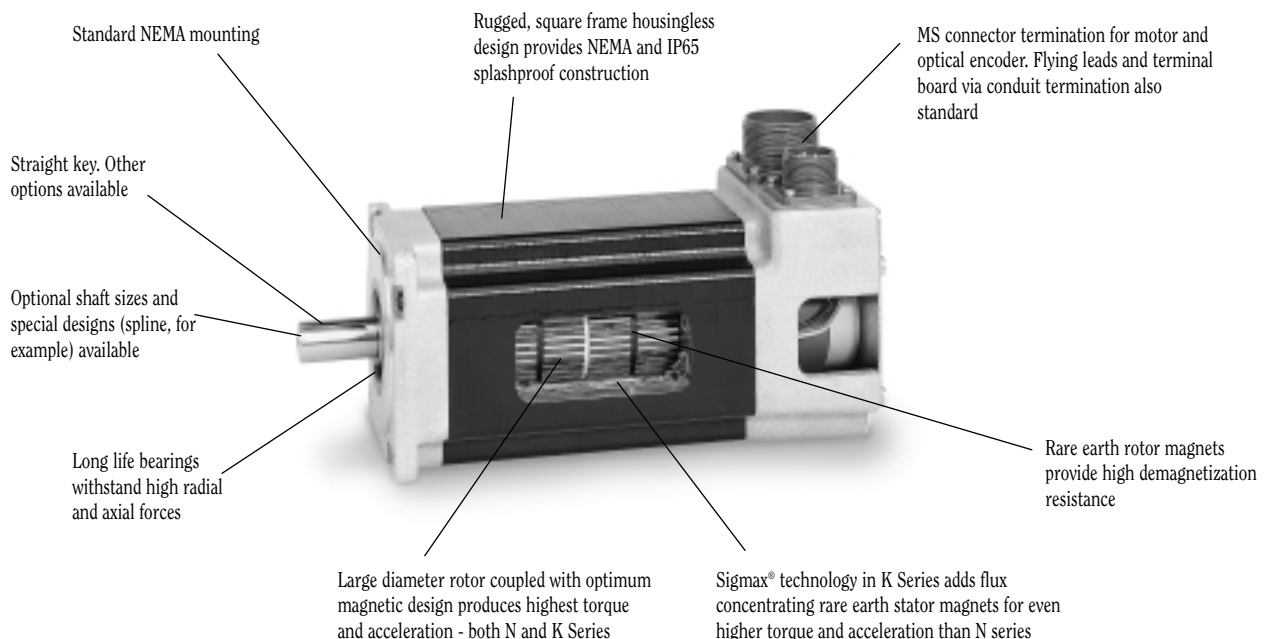

POWERPAC™ HYBRIDS INDEX

How to use this section

This guide covers the technical information required to select and order POWERPAC hybrid step motors. Select the proper motor using one of the following procedures.

- If you're already familiar with these motors and the available options, refer to the Model Number Codes on pages 14 (NEMA 34) and 25 (NEMA 42) to verify coded information prior to ordering.
- If you're not familiar with these motors and the available options:
 - refer to the Selection Overview, p. 13, and Technical Overview, p. 3-4. Ratings and Characteristics for the NEMA 34 frame start on p. 15 and p. 26 for the NEMA 42 frame. Both are followed by torque and acceleration comparisons, torque/speed curves and drawings as shown in the index at the right. Technical data common to both NEMA 34 and 42 frames, including connections, phasing diagrams, encoder options, shaft loading and bearing fatigue life starts on page 34. To order, construct a Model Number (pp. 14 and 25) after all the technical parameters, including options, are determined.
 - If Application Assistance is required, see the section starting on page 6.
 - Use OPTIMIZER® Version 3.0, our Windows™ compatible sizing and selection software for both hybrid steppers and brushless servomotors. Optimizer will select a motor, however, it may not include all the options required. Construct a model number after all the technical parameters, including options, are determined. Call or fax us for your free disk or visit us at www.pacsci.com

Product Overview	Inside front cover
How to use this Section	12
Features	11
Selection Overview	13
Technical Overview	3-4
Hybrid Step Motor Technology	5
Application Assistance	6-9
NEMA 34 Frame Motors	
Model Number Code	14
Ratings and Characteristics	15-18
Torque and Acceleration Comparisons	19
Torque Linearity Curves	20
Performance (Torque/Speed) Curves	21-22
Drawings	23-24
NEMA 42 Frame Motors	
Model Number Code	25
Ratings and Characteristics	26-28
Torque and Acceleration Comparisons	19, 29
Torque Linearity Curves	29
Performance (Torque/Speed) Curves	30-31
Drawings	32-33
Motor Technical Data	
Power Connections	34-35
Phase Sequencing Tables	36
Encoder Mounting Options	36
Shaft Loading	37
Bearing Fatigue Life	37



POWERPAC™ HYBRIDS SELECTION OVERVIEW

POWERPAC™ HYBRIDS

		NEMA 34			NEMA 42		
		(3.38" square frame)			(4.325" square frame)		
		Holding torque	Torque-to-inertia ratio*	Page	Holding torque	Torque-to-inertia ratio*	Page
		oz-in. (Nm)	$\frac{\text{rad}}{\text{s}^2} \times 10^3$		oz-in. (Nm)	$\frac{\text{rad}}{\text{s}^2} \times 10^3$	
K Series - Sigmax® flux focusing technology	1 stack	845(5.96)	41.8	15	2135(15.07)	27.3	26
	2 stacks	1580(11.15)	41.6	16	4025(28.41)	26.0	27
	3 stacks	2340(16.52)	41.3	17	5700(40.23)	24.9	28
	4 stacks	2790(19.69)	37.2	18	NA	NA	
N Series - Standard	1 stack	665(4.65)	32.9	15	1655(11.68)	21.1	26
	2 stacks	1295(8.79)	32.8	16	3145(22.20)	20.3	27
	3 stacks	1845(13.02)	32.5	17	4365(30.81)	19.0	28
	4 stacks	2180(15.39)	29.1	18	NA	NA	

* $\frac{\text{Holding Torque}}{\text{Rotor Inertia}}$...a figure of merit for acceleration capability

POWERPAC™ HYBRIDS

NEMA 34 Frame

(3.38" Square)

MODEL NUMBER CODE

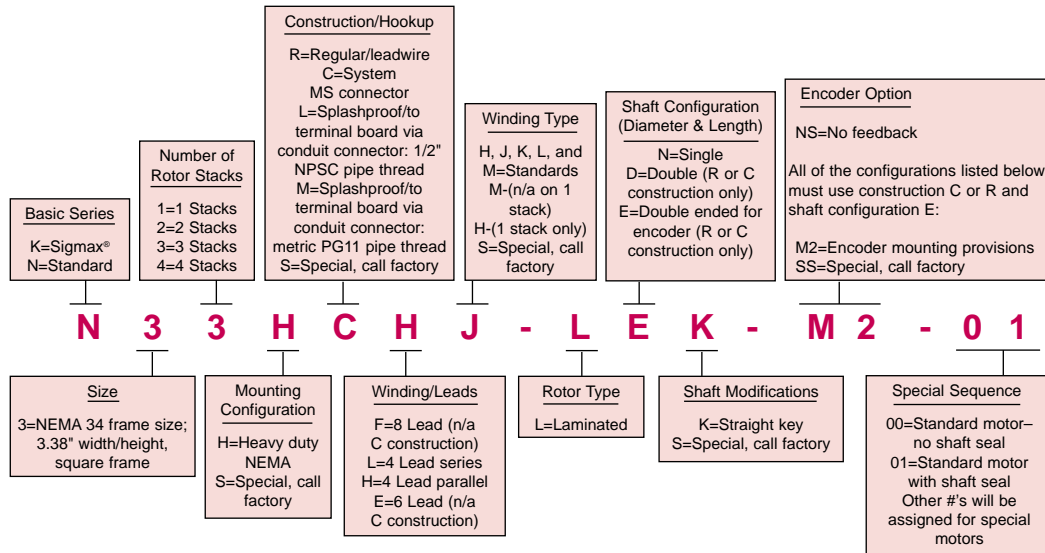

The example model number above indicates a N series standard NEMA 34 frame motor with a three stack rotor. This motor is equipped with a heavy duty front end bell and shaft, and a sealed system rear end bell with MS connectors. It also has a bipolar parallel connection, a J winding, a straight keyway, encoder mounting options and a shaft seal.

HOW TO ORDER

Review the Motor Model Number Code to assure that all options are designated. Call your nearest Pacific Scientific Motor Products Distributor to place orders and for application assistance. If you need to identify your Distributor, call the Motor Products Division at (815) 226-3100.

POWERPAC HYBRIDS

Also see:

- Torque and Acceleration Comparisons, p. 19
- Torque Linearity Curves, p. 20
- Performance Curves, p. 21-22

NEMA 34 FRAME (3.38" Square)—Ratings and Characteristics

Review the Model Number Code, page 14, to assure that all options are designated. Connections, encoders and phasing diagrams start on page 34. Motor dimensions start on page 23. In addition to those below, motors with characteristics for specific performance requirements are offered. Contact factory for more details.

Rated currents are in descending order	Motor Model Number Δ	Connection Δ			Holding Torque Δ (2 phases on) oz-in (Nm) $\pm 10\%$	Rated Current/Phase Δ (amps DC)	Phase Resistance (ohms) $\pm 10\%$	Phase Inductance Δ (mH) Typical	Detent Torque oz-in (Nm)	Thermal Resistance Δ (°C/watt)	Rotor Inertia oz-in-S ² (kgm ² x 10 ⁻³)	Weight lbs (kg)					
		Parallel	Series	Unipolar													
Torque range: 570-845 oz-in. 35.6-52.8 lb-in. 4.02-5.96 Nm	K31HXHL-LXK-XX-XX	•			830 (5.86)	8.6	0.18	1.2	↑	↑	↑	↑					
	K31HXL-LXK-XX-XX	•			830 (5.86)	4.3	0.72	4.7									
	K31HXEL-LXK-XX-XX		•		590 (4.16)	6.1	0.36	1.2									
	K Series - SIGMAX® 1 rotor stack	K31HXHK-LXK-XX-XX	•			845 (5.96)	6.6	0.29					2.1				
		K31HXLK-LXK-XX-XX		•		845 (5.96)	3.3	1.16					8.3				
		K31HXEK-LXK-XX-XX			•	600 (4.23)	4.7	0.58					2.1				
		K31HXHJ-LXK-XX-XX	•			820 (5.79)	5.5	0.42					2.8	25 (0.18)	2.7	0.0202 (0.14)	5 (2.27)
		K31HXLJ-LXK-XX-XX		•		820 (5.79)	2.7	1.69					11.4				
		K31HXEJ-LXK-XX-XX			•	580 (4.09)	3.9	0.84					2.8				
	K31HXHH-LXK-XX-XX	•			805 (5.68)	2.8	1.55	10.2	↓	↓	↓	↓					
	K31HXLH-LXK-XX-XX		•		805 (5.68)	1.4	6.21	40.7									
	K31HXEH-LXK-XX-XX			•	570 (4.02)	1.98	3.1	10.2									
Torque range: 450-665 oz-in. 28.1-41.5 lb-in. 3.18-4.69 Nm	N31HXHL-LXK-XX-XX	•			650 (4.59)	8.6	0.18	1.4	↑	↑	↑	↑					
	N31HXL-LXK-XX-XX	•			650 (4.59)	4.3	0.72	5.8									
	N31HXEL-LXK-XX-XX		•		460 (3.25)	6.1	0.36	1.4									
	N Series - Standard 1 rotor stack	N31HXHK-LXK-XX-XX	•			665 (4.69)	6.6	0.29					2.6				
		N31HXLK-LXK-XX-XX		•		665 (4.69)	3.3	1.16					10.3				
		N31HXEK-LXK-XX-XX			•	470 (3.32)	4.7	0.58					2.6				
		N31HXHJ-LXK-XX-XX	•			645 (4.55)	5.5	0.42					3.5	18 (0.13)	2.7	0.0202 (0.14)	5 (2.27)
		N31HXLJ-LXK-XX-XX		•		645 (4.55)	2.7	1.69					14				
		N31HXEJ-LXK-XX-XX			•	455 (3.21)	3.9	0.84					3.5				
	N31HXHH-LXK-XX-XX	•			635 (4.48)	2.8	1.55	12.5	↓	↓	↓	↓					
	N31HXLH-LXK-XX-XX		•		635 (4.48)	1.4	6.21	50.1									
	N31HXEH-LXK-XX-XX			•	450 (3.18)	1.98	3.1	12.5									

All ratings typical and at 25°C unless otherwise noted.

- Δ An "X" in the Model Number Code indicates an undefined option. Colored letter indicates winding. See Model Number Code on page 14.
- Δ Motor connections are determined by the Windings/Leads designation in the Model Number Code on page 14. Note that the F designation, although not shown in the above tables, is an 8-lead option...see Terminations, page 34. In addition to the lead wire termination, terminal board and MS connector hookup for parallel, series or unipolar operation is also available.

- Δ With rated current applied. Windings at 130°C and motor unmounted and in still air at 40°C.
- Δ Windings at 130°C and motor in still air at 40°C (without heat sink). Motors may be operated up to 2 times rated current to provide high peak torque with good torque linearity - **duty cycle dependant, contact factory.**
- Δ Small signal inductance as measured with impedance bridge at 1kHz, 1 amp.
- Δ Thermal resistance measured with motor hanging in still air (unmounted).

POWERPAC HYBRIDS

Also see:

- Torque and Acceleration Comparisons, p. 19
- Torque Linearity Curves, p. 20
- Performance Curves, p. 21-22

NEMA 34 FRAME (3.38" Square)—Ratings and Characteristics (Con't)

Review the Model Number Code, page 14, to assure that all options are designated. Connections, encoders and phasing diagrams start on page 34. Motor dimensions start on page 23. In addition to those below, motors with characteristics for specific performance requirements are offered. Contact factory for more details.

Rated currents are in descending order	Motor Model Number Δ	Connection Δ			Holding Torque Δ (2 phases on) oz-in (Nm) $\pm 10\%$	Rated Current/Phase Δ (amps DC)	Phase Resistance (ohms) $\pm 10\%$	Phase Inductance Δ (mH) Typical	Detent Torque oz-in (Nm)	Thermal Resistance Δ (°C/watt)	Rotor Inertia oz-in-S ² (kgm ² x 10 ⁻³)	Weight lbs (kg)					
		Parallel	Series	Unipolar													
Torque range: 1065-1580 oz-in. 66.5-98.7 lb-in. 7.52-11.15 Nm	K32HXHM-LXK-XX-XX	•			1535 (10.83)	10	0.18	1.4	↑	↑	↑	↑					
	K32HXLMLXK-XX-XX	•			1535 (10.83)	5	0.7	5.5									
	K32HXEM-LXK-XX-XX		•		1085 (7.66)	7.1	0.35	1.4									
	<hr/>																
	K Series - SIGMAX® 2 rotor stacks	K32HXHL-LXK-XX-XX	•			1515 (10.69)	8.1	0.26					2				
		K32HXL-LXK-XX-XX		•		1515 (10.69)	4.1	1.03					8.1				
		K32HXEL-LXK-XX-XX			•	1070 (7.55)	5.8	0.52					2				
		<hr/>															
		K32HXHK-LXK-XX-XX	•			1580 (11.15)	6.1	0.45					4				
K32HXLK-LXK-XX-XX			•		1580 (11.15)	3	1.8	16.2									
K32HXEK-LXK-XX-XX			•	1120 (7.90)	4.3	0.9	4										
<hr/>																	
K32HXHJ-LXK-XX-XX	•			1510 (10.66)	5.1	0.63	5.1										
K32HXLJ-LXK-XX-XX		•		1510 (10.66)	2.5	2.53	20.5										
K32HXEJ-LXK-XX-XX			•	1065 (7.52)	3.5	1.27	5.1										
<hr/>																	
Torque range: 845-1245 oz-in. 52.8-77.8 lb-in. 5.96-8.79 Nm	N32HXHM-LXK-XX-XX	•			1215 (8.58)	10	0.18	1.8	↑	↑	↑	↑					
	N32HXLMLXK-XX-XX	•			1215 (8.58)	5	0.7	7									
	N32HXEM-LXK-XX-XX		•		860 (6.07)	7.1	0.35	1.8									
	<hr/>																
	N Series - Standard 2 rotor stacks	N32HXHL-LXK-XX-XX	•			1200 (8.47)	8.1	0.26					2.6				
		N32HXL-LXK-XX-XX		•		1200 (8.47)	4.1	1.03					10.3				
		N32HXEL-LXK-XX-XX			•	850 (6.00)	5.8	0.52					2.6				
		<hr/>															
		N32HXHK-LXK-XX-XX	•			1245 (8.79)	6.1	0.45					5.1				
N32HXLK-LXK-XX-XX			•		1245 (8.79)	3	1.8	20.6									
N32HXEK-LXK-XX-XX			•	885 (6.25)	4.3	0.9	5.1										
<hr/>																	
N32HXHJ-LXK-XX-XX	•			1195 (8.43)	5.1	0.63	6.5										
N32HXLJ-LXK-XX-XX		•		1195 (8.43)	2.5	2.53	26										
N32HXEJ-LXK-XX-XX			•	845 (5.96)	3.5	1.27	6.5										

All ratings typical and at 25°C unless otherwise noted.

- Δ An "X" in the Model Number Code indicates an undefined option. Colored letter indicates winding. See Model Number Code on page 14.
- Δ Motor connections are determined by the Windings/Leads designation in the Model Number Code on page 14. Note that the F designation, although not shown in the above tables, is an 8-lead option...see Terminations, page 34. In addition to the lead wire termination, terminal board and MS connector hookup for parallel, series or unipolar operation is also available.

Δ With rated current applied. Windings at 130°C and motor unmounted and in still air at 40°C.

Δ Windings at 130°C and motor in still air at 40°C (without heat sink). Motors may be operated up to 2 times rated current to provide high peak torque with good torque linearity - **duty cycle dependant, contact factory.**

Δ Small signal inductance as measured with impedance bridge at 1kHz, 1 amp.

Δ Thermal resistance measured with motor hanging in still air (unmounted).

POWERPAC HYBRIDS

Also see:

- Torque and Acceleration Comparisons, p. 19
- Torque Linearity Curves, p. 20
- Performance Curves, p. 21-22

NEMA 34 FRAME (3.38" Square)—Ratings and Characteristics (Con't)

Review the Model Number Code, page 14, to assure that all options are designated. Connections, encoders and phasing diagrams start on page 34. Motor dimensions start on page 23. In addition to those below, motors with characteristics for specific performance requirements are offered. Contact factory for more details.

Rated currents are in descending order	Motor Model Number [△]	Connection [△]			Holding Torque [△] (2 phases on oz-in (Nm) ±10%)	Rated Current/Phase [△] (amps DC)	Phase Resistance (ohms) ±10%	Phase Inductance [△] (mH) Typical	Detent Torque oz-in (Nm)	Thermal Resistance [△] (°C/watt)	Rotor Inertia oz-in-S ² (kgm ² x 10 ⁻³)	Weight lbs (kg)	
		Parallel	Series	Unipolar									
Torque range: 1515-2348 oz-in. 94.7-146.2 lb-in. 10.69-16.52 Nm	K33HXHM-LXK-XX-XX	•			2150(15.17)	9.9	0.22	1.7	↑	↑	↑	↑	
	K33HXL M-LXK-XX-XX	•			2150(15.17)	5	0.87	7					
	K33HXEM-LXK-XX-XX	•			1520(10.73)	7	0.44	1.7					
	K Series - SIGMAX® 3 rotor stacks	K33HXHL-LXK-XX-XX	•			2340(16.52)	9	0.26					2.6
		K33HXL L-LXK-XX-XX	•			2340(16.52)	4.5	1.06					10.6
		K33HXEL-LXK-XX-XX	•			1655(11.68)	6.3	0.53					2.6
		K33HXHK-LXK-XX-XX	•			2205(15.56)	6.1	0.56					5
		K33HXL K-LXK-XX-XX	•			2205(15.56)	3	2.23					19.9
		K33HXEK-LXK-XX-XX	•			1560(11.01)	4.3	1.12					5
K33HXHJ-LXK-XX-XX	•			2145(15.14)	5	0.83	7						
K33HXL J-LXK-XX-XX	•			2145(15.14)	2.5	3.31	27.9						
K33HXE J-LXK-XX-XX	•			1515(10.69)	3.5	1.65	7						
Torque range: 1210-1845 oz-in. 75.6-115.3 lb-in. 8.54-13.02 Nm	N33HXHM-LXK-XX-XX	•			1715(12.10)	9.9	0.22	2.3	↑	↑	↑	↑	
	N33HXL M-LXK-XX-XX	•			1715(12.10)	5	0.87	9					
	N33HXEM-LXK-XX-XX	•			1215(8.58)	7	0.44	2.3					
	N Series - Standard 3 rotor stacks	N33HXHL-LXK-XX-XX	•			1845(13.02)	9	0.26					3.4
		N33HXL L-LXK-XX-XX	•			1845(13.02)	4.5	1.06					13.6
		N33HXEL-LXK-XX-XX	•			1305(9.21)	6.3	0.53					3.4
		N33HXHK-LXK-XX-XX	•			1755(12.39)	6.1	0.56					6.4
		N33HXL K-LXK-XX-XX	•			1755(12.39)	3	2.23					25.8
		N33HXEK-LXK-XX-XX	•			1240(8.75)	4.3	1.12					6.4
N33HXHJ-LXK-XX-XX	•			1710(12.07)	5	0.83	9						
N33HXL J-LXK-XX-XX	•			1710(12.07)	2.5	3.31	36						
N33HXE J-LXK-XX-XX	•			1210(8.54)	3.5	1.65	9						

All ratings typical and at 25°C unless otherwise noted.

- [△] An "X" in the Model Number Code indicates an undefined option. Colored letter indicates winding. See Model Number Code on page 14.
- [△] Motor connections are determined by the Windings/Leads designation in the Model Number Code on page 14. Note that the F designation, although not shown in the above tables, is an 8-lead option...see Terminations, page 34. In addition to the lead wire termination, terminal board and MS connector hookup for parallel, series or unipolar operation is also available.

[△] With rated current applied. Windings at 130°C and motor unmounted and in still air at 40°C.

- [△] Windings at 130°C and motor in still air at 40°C (without heat sink). Motors may be operated up to 2 times rated current to provide high peak torque with good torque linearity - **duty cycle dependant, contact factory.**
- [△] Small signal inductance as measured with impedance bridge at 1kHz, 1 amp.
- [△] Thermal resistance measured with motor hanging in still air (unmounted).

POWERPAC HYBRIDS

Also see:

- Torque and Acceleration Comparisons, p. 19
- Torque Linearity Curves, p. 20
- Performance Curves, p. 21-22

NEMA 34 FRAME (3.38" Square)—Ratings and Characteristics (Con't)

Review the Model Number Code, page 14, to assure that all options are designated. Connections, encoders and phasing diagrams start on page 34. Motor dimensions start on page 23. In addition to those below, motors with characteristics for specific performance requirements are offered. Contact factory for more details.

Rated currents are in descending order	Motor Model Number Δ	Connection Δ			Holding Torque Δ (2 phases on) oz-in (Nm) $\pm 10\%$	Rated Current/Phase Δ (amps DC)	Phase Resistance (ohms) $\pm 10\%$	Phase Inductance Δ (mH) Typical	Detent Torque oz-in (Nm)	Thermal Resistance Δ (°C/watt)	Rotor Inertia oz-in-S ² (kgm ² x 10 ⁻³)	Weight lbs (kg)					
		Parallel	Series	Unipolar													
Torque range: 1825-2798 oz-in. 114.1-174.4 lb-in. 12.88-19.69 Nm	K34HXHM-LXK-XX-XX	•			2725(19.23)	11.3	0.2	2	↑	↑	↑	↑					
	K34HXLN-LXK-XX-XX	•			2725(19.23)	5.6	0.82	8.2									
	K34HXEM-LXK-XX-XX		•		1930(13.62)	8	0.41	2									
	<hr/>																
	K Series - SIGMAX® 4 rotor stacks	K34HXHL-LXK-XX-XX	•			2790(19.69)	8.7	0.33					3.6				
		K34HXLN-LXK-XX-XX		•		2790(19.69)	4.4	1.32					14.5				
		K34HXEL-LXK-XX-XX			•	1975(13.94)	6.2	0.66					3.6				
		<hr/>															
		K34HXHK-LXK-XX-XX	•			2580(18.21)	6	0.67					6.3	65 (0.50)	1.3	0.075 (0.53)	15.1 (6.84)
		K34HXLN-LXK-XX-XX		•		2580(18.21)	3	2.69					25.1				
		K34HXEK-LXK-XX-XX			•	1825(12.88)	4.3	1.35					6.3				
		<hr/>															
K34HXHJ-LXK-XX-XX		•			2770(19.55)	5.5	0.8	8.9									
K34HXLN-LXK-XX-XX			•		2770(19.55)	2.8	3.19	35.5									
K34HXEJ-LXK-XX-XX				•	1960(13.83)	3.9	1.6	8.9									
<hr/>																	
Torque range: 1940-2180 oz-in. 90.0-136.2 lb-in. 10.16-15.39 Nm	N34HXHM-LXK-XX-XX	•			2140(15.10)	11.3	0.2	2.6	↑	↑	↑	↑					
	N34HXLN-LXK-XX-XX	•			2140(15.10)	5.6	0.82	10.6									
	N34HXEM-LXK-XX-XX		•		1510(10.66)	8	0.41	2.6									
	<hr/>																
	N Series - Standard 4 rotor stacks	N34HXHL-LXK-XX-XX	•			2180(15.39)	8.7	0.33					4.7				
		N34HXLN-LXK-XX-XX		•		2180(15.39)	4.4	1.32					18.8				
		N34HXEL-LXK-XX-XX			•	1545(10.90)	6.2	0.66					4.7				
		<hr/>															
		N34HXHK-LXK-XX-XX	•			2035(14.36)	6	0.67					8.1	57 (0.40)	1.3	0.075 (0.53)	15.1 (6.84)
		N34HXLN-LXK-XX-XX		•		2035(14.36)	3	2.69					32.4				
		N34HXEK-LXK-XX-XX			•	1440(10.16)	4.3	1.35					8.1				
		<hr/>															
N34HXHJ-LXK-XX-XX		•			2170(15.32)	5.5	0.8	11.5									
N34HXLN-LXK-XX-XX			•		2170(15.32)	2.8	3.19	45.9									
N34HXEJ-LXK-XX-XX				•	1535(10.83)	3.9	1.6	11.5									

All ratings typical and at 25°C unless otherwise noted.

Δ An "X" in the Model Number Code indicates an undefined option. Colored letter indicates winding. See Model Number Code on page 14.

Δ Motor connections are determined by the Windings/Leads designation in the Model Number Code on page 14. Note that the F designation, although not shown in the above tables, is an 8-lead option...see Terminations, page 34. In addition to the lead wire termination, terminal board and MS connector hookup for parallel, series or unipolar operation is also available.

Δ With rated current applied. Windings at 130°C and motor unmounted and in still air at 40°C.

Δ Windings at 130°C and motor in still air at 40°C (without heat sink). Motors may be operated up to 2 times rated current to provide high peak torque with good torque linearity - **duty cycle dependant, contact factory.**

Δ Small signal inductance as measured with impedance bridge at 1kHz, 1 amp.

Δ Thermal resistance measured with motor hanging in still air (unmounted).

Torque and Acceleration Comparisons

**NEMA 34 FRAME (3.38" Square)—
Torque and Acceleration Comparisons**

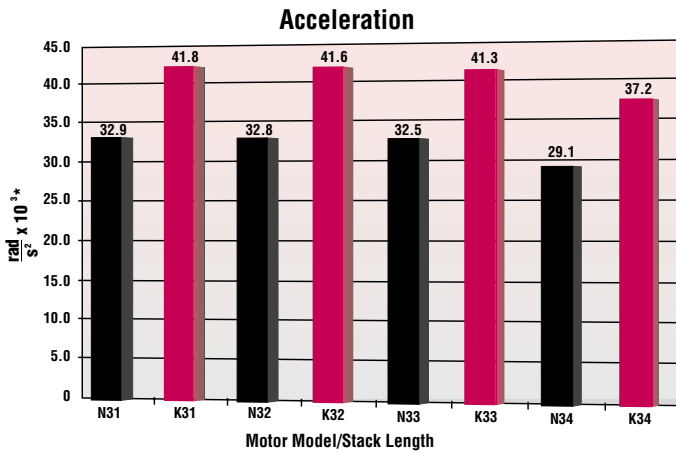
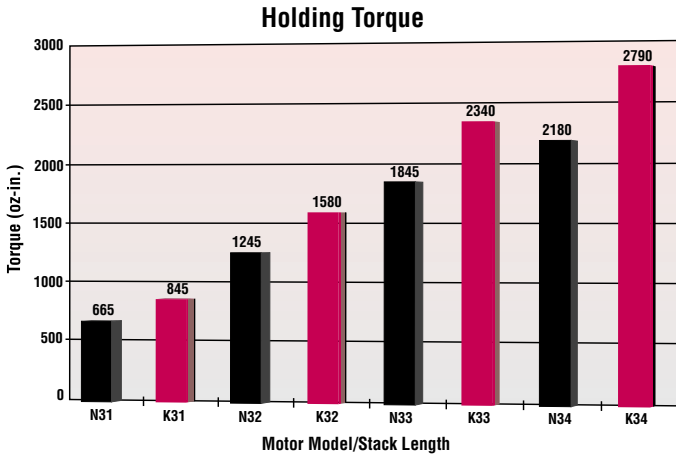

* Holding Torque ...a figure of merit for acceleration capability
Rotor Inertia

NEMA 42 FRAME (4.325" Square)—
Torque and Acceleration Comparisons**

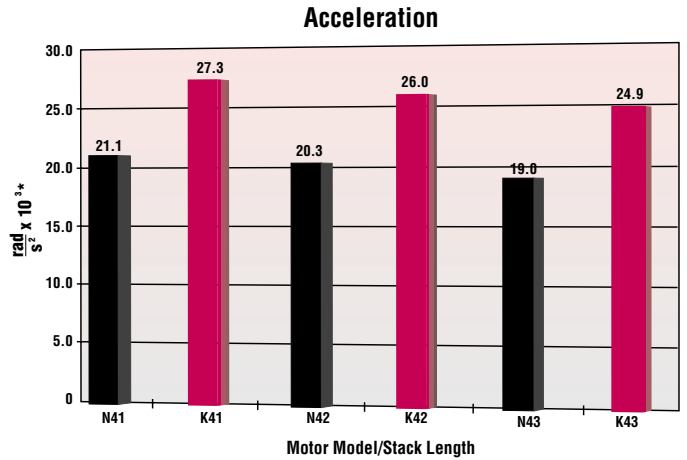
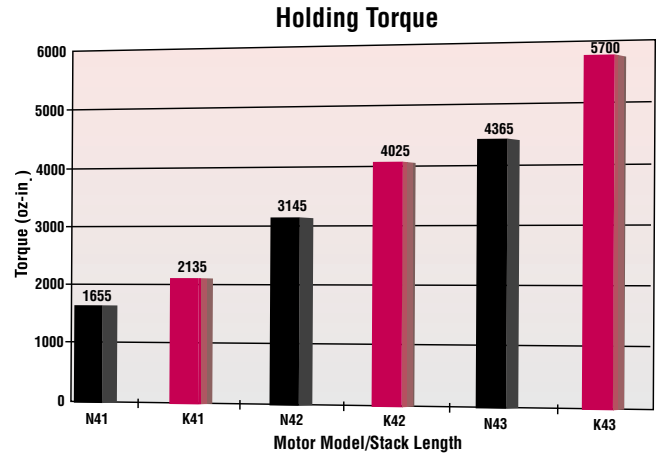

* Holding Torque ...a figure of merit for acceleration capability
Rotor Inertia

** Size 42 data shown here for comparison. NEMA 42 starts on page 25.

POWERPAC HYBRIDS

NEMA 34 FRAME (3.38" Square)—Torque Linearity

A significant POWERPAC performance attribute is that when a current higher than rated current is applied, the increase in torque will be more linear than other hybrids. Furthermore, current levels increasingly higher than rated current are less likely to cause demagnetization. Capitalize on this performance characteristic which will provide an acceleration boost to move loads even faster. This technique is applicable to intermittent duty applications in that the thermal limit of the motor cannot be exceeded. Driving the motor at higher than rated current is duty cycle dependent. Contact the factory for application assistance.

These curves show the torque at rated current and the torque linearity up to two times rated current.

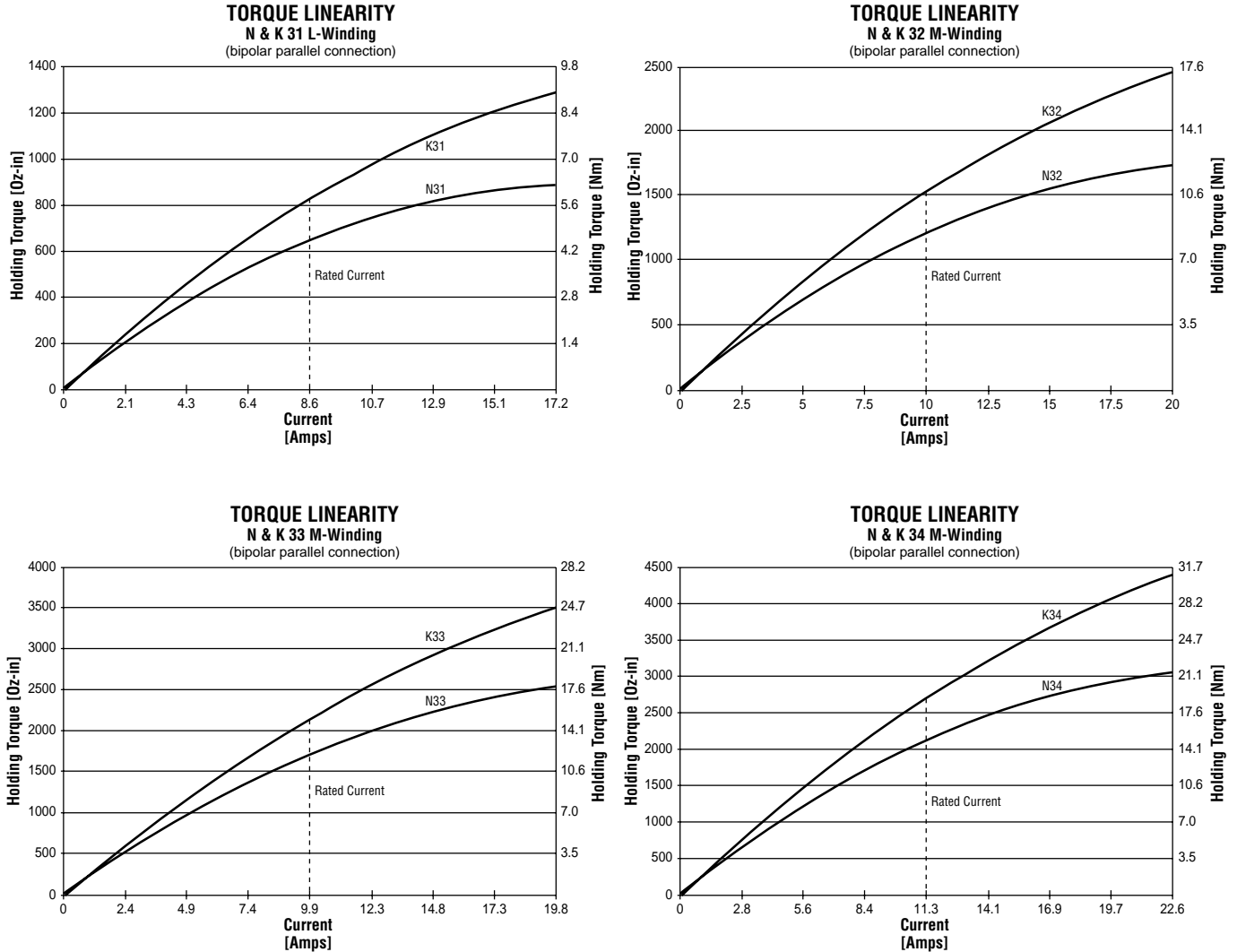

POWERPAC HYBRIDS

NEMA 34 FRAME (3.38" Square)—Performance

Motors will perform continuously as shown without the winding temperature exceeding 130°C when the motor is operated (without heat sink) in an ambient temperature of up to 40°C. The curves do not reflect system resonance points, which will vary with motor coupling and system parameters.

NEMA 34 FRAME – ONE ROTOR STACK

5A per phase; K31* and N31*

J winding, parallel connection, See Ratings and Characteristics, p. 15.

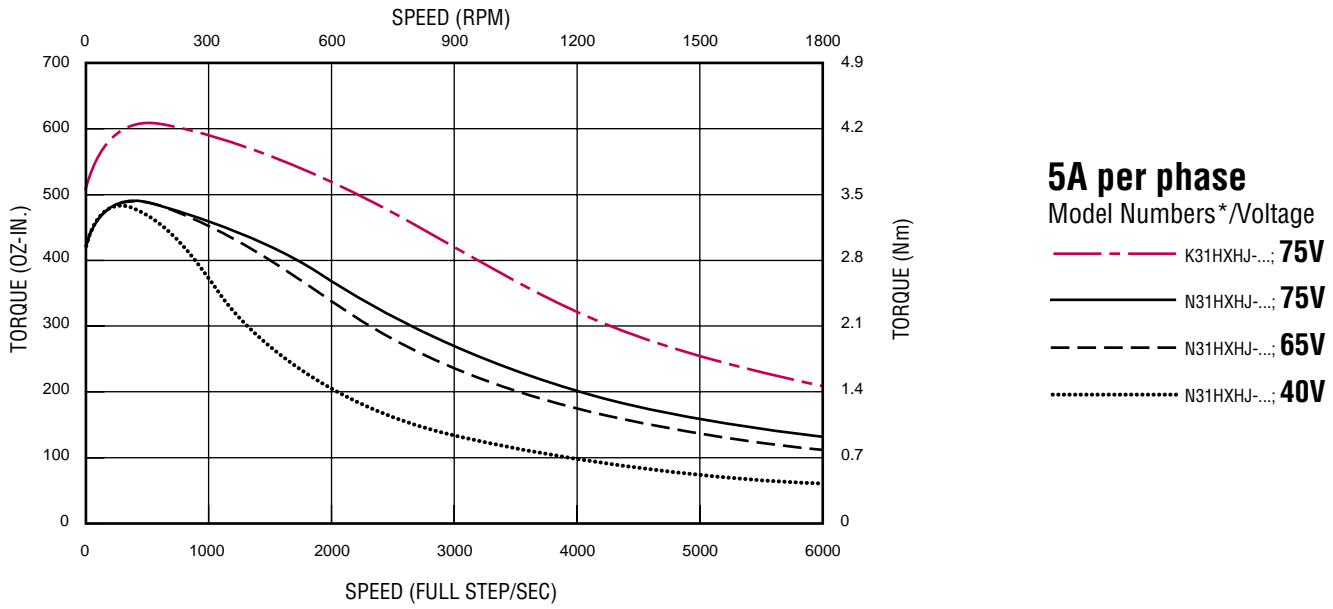

NEMA 34 FRAME – TWO ROTOR STACKS

5A per phase; K32* and N32*

J winding, parallel connection, See Ratings and Characteristics, p. 16.

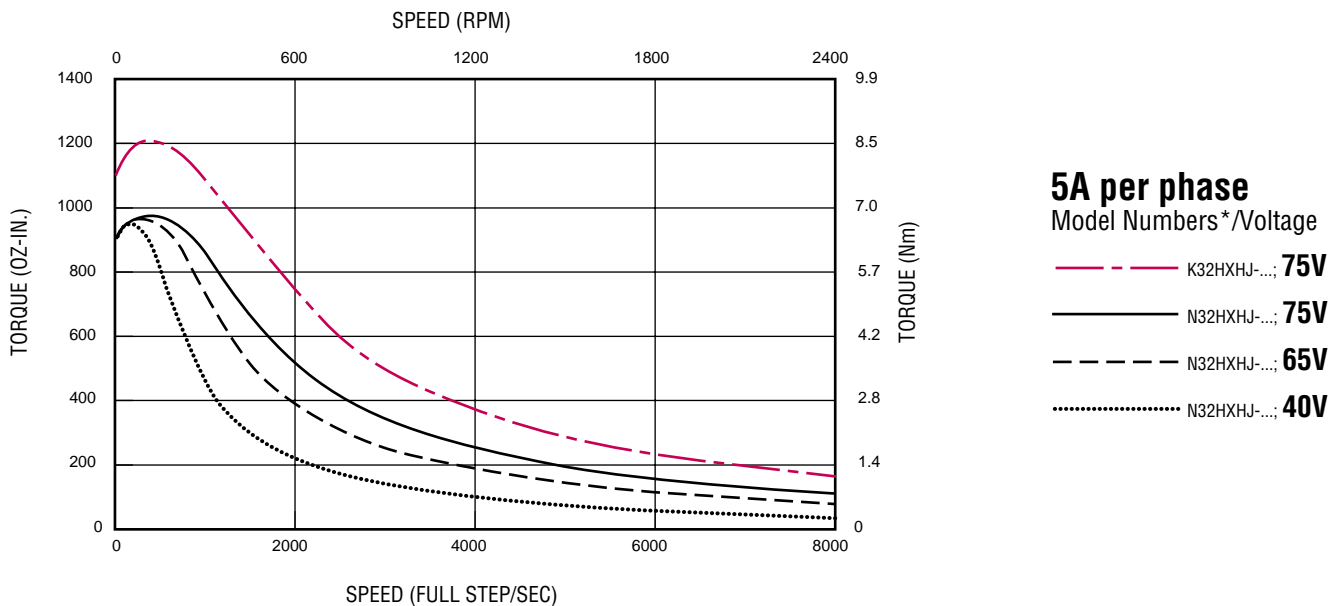

*See Model Number Code on page 14 for clarification.

POWERPAC HYBRIDS

NEMA 34 FRAME (3.38" Square)—Performance

Motors will perform continuously as shown without the winding temperature exceeding 130°C when the motor is operated (without heat sink) in an ambient temperature of up to 40°C. The curves do not reflect system resonance points, which will vary with motor coupling and system parameters.

NEMA 34 FRAME – THREE ROTOR STACKS

5A per phase; K33* and N33*

J winding, parallel connection, See Ratings and Characteristics, p. 17.

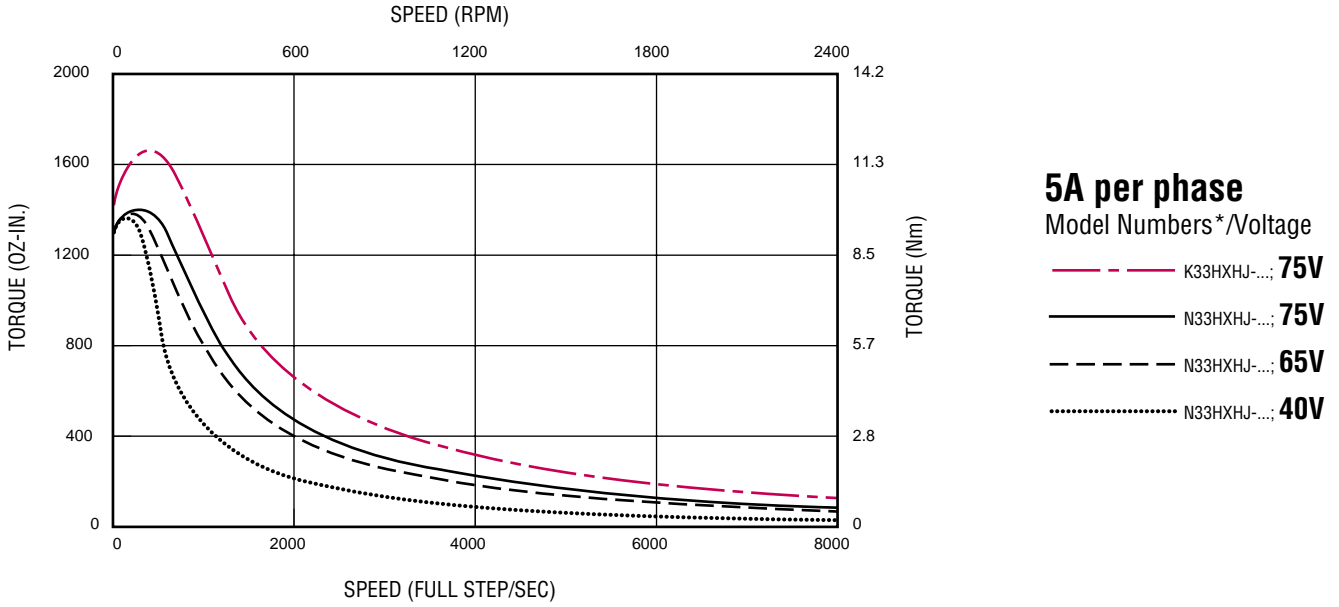

NEMA 34 FRAME – FOUR ROTOR STACKS

5A per phase; K34* and N34*

J winding, parallel connection, See Ratings and Characteristics, p. 18.

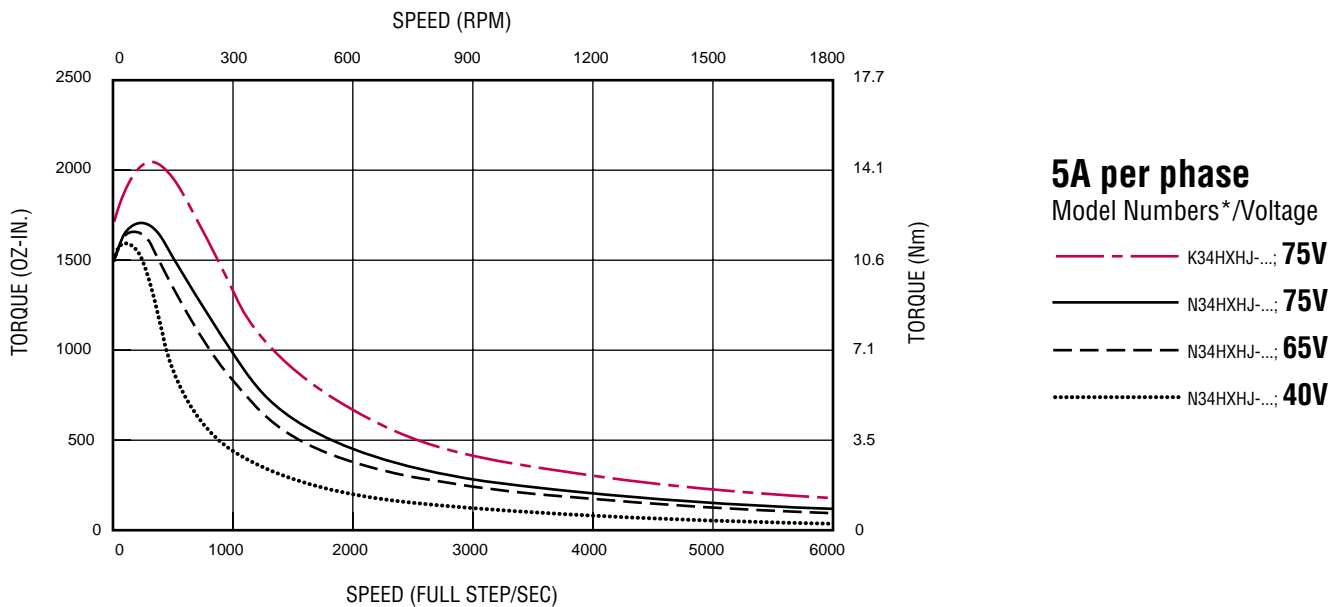

*See Model Number Code on page 14 for clarification.

DIMENSIONS . . . POWERPAC HYBRIDS

in. (metric dimensions for ref. only)
mm

NEMA 34 FRAME: All motors have a heavy duty NEMA front end bell and large diameter shaft to support the higher output torques

LEADWIRE HOOKUP - ENCODER OPTIONS

Model Number Code designation R (Construction/Hookup), p. 14.

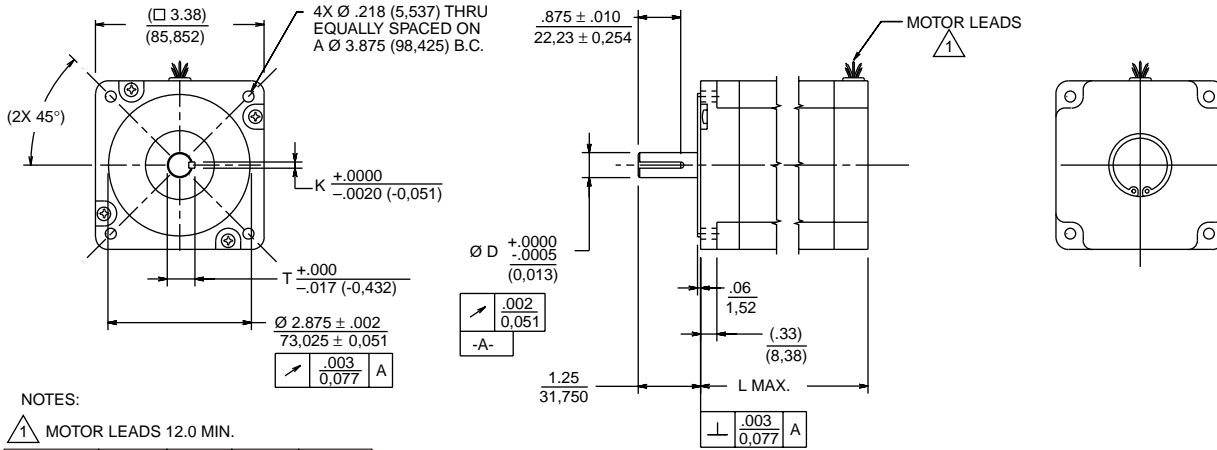

NOTES:

$\triangle 1$ MOTOR LEADS 12.0 MIN.

MOTOR	D	K	T	L MAX
31 HR	.5000 12,700	.1250 3,175	.555 14,097	3.13 79,502
32 HR	.5000 12,700	.1250 3,175	.555 14,097	4.65 118,11
33 HR	.6250 15,875	.1875 4,763	.705 17,907	6.13 155,70
34 HR	.6250 15,875	.1875 4,763	.705 17,907	7.68 195,07

LEADWIRE HOOKUP DOUBLE SHAFT CONFIGURATION

Model Number Code designation D (Shaft Configuration), p. 14.

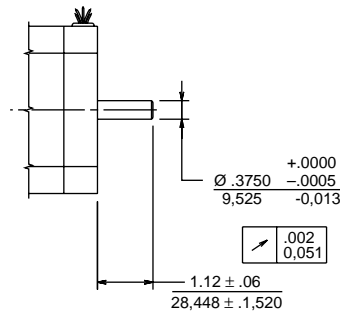

LEADWIRE HOOKUP ENCODER MOUNTING PROVISION

Model Number Code designation M2 (Encoder Mounting Options), p. 14.

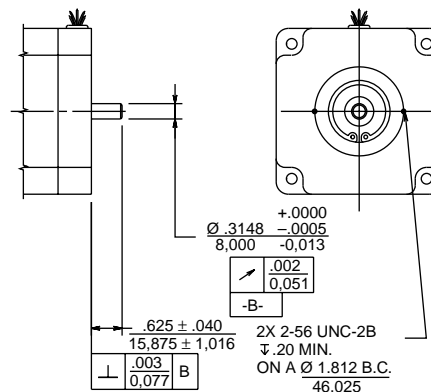

DIMENSIONS . . . POWERPAC HYBRIDS

in. (metric dimensions for ref. only)
mm

NEMA 34 FRAME: All motors have a heavy duty NEMA front end bell and large diameter shaft to support the higher output torques

SPLASHPROOF CONSTRUCTION/TERMINAL BOARD CONNECTIONS

(via English or Metric thread for conduit) Model Number Code designation L or M (Construction/Hookup), p 14.

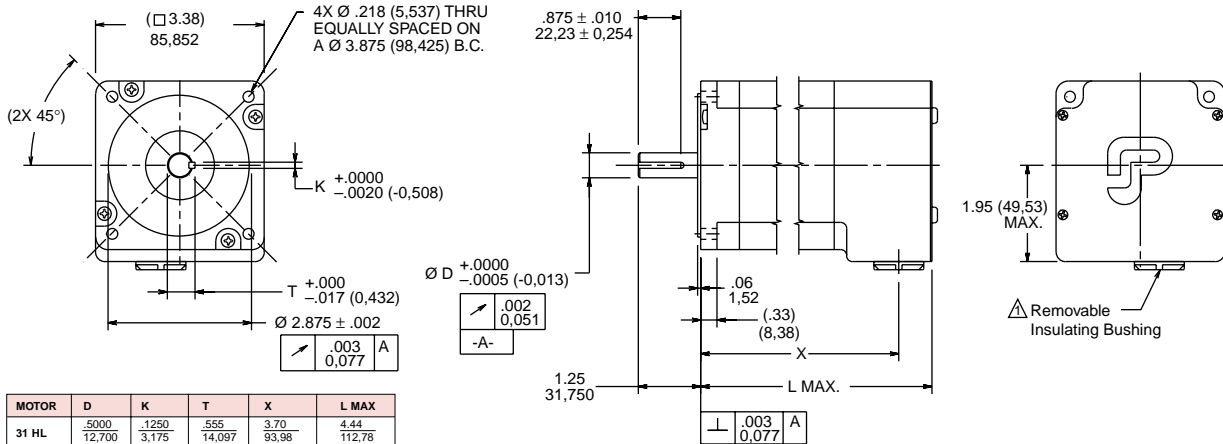

* See Model Number Code, p 14.

SPLASHPROOF CONSTRUCTION/MS CONNECTOR(S)— ENCODER OPTION

Model Number Code designation C/System (Construction/Hookup) and Encoder Mounting Option, p 14.

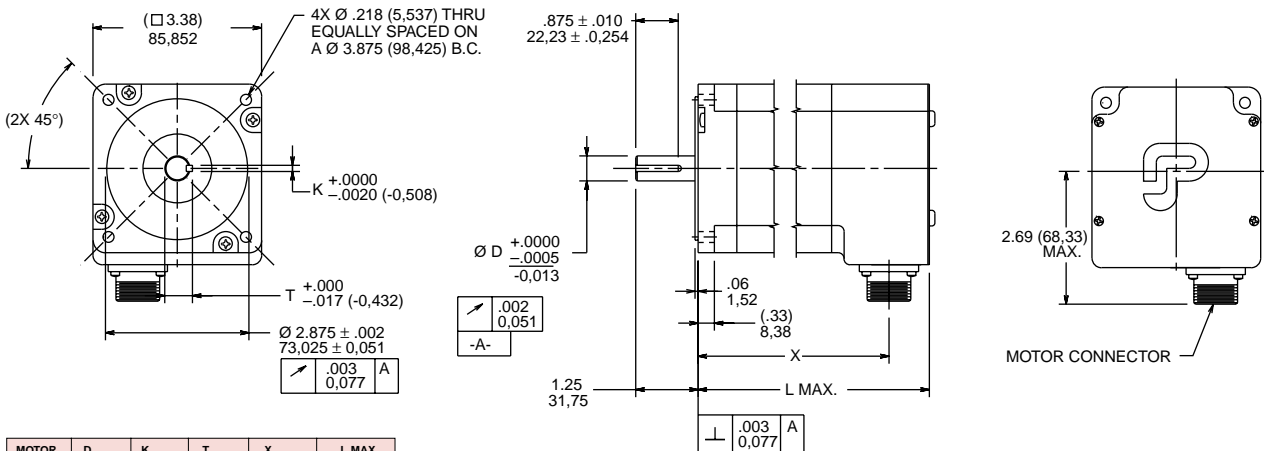

* See Model Number Code, p 14.

NOTES:

- △ L Construction = Conduit connection (1/2 NPSC TAP) with $\frac{56}{14,2}$ I.D. removable insulating bushing
- M Construction = Conduit connection (PG 11 TAP). (No insulating bushing supplied)

ENCODER MOUNTING OPTION

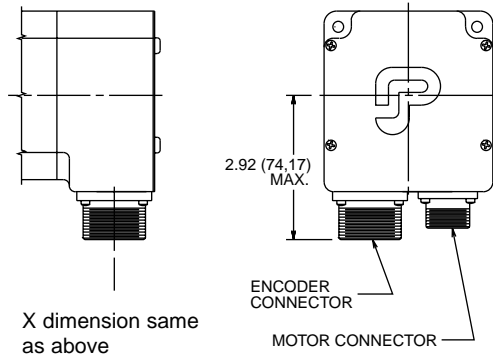

POWERPAC™ HYBRIDS

NEMA 42 Frame (4.325" Square)

MODEL NUMBER CODE

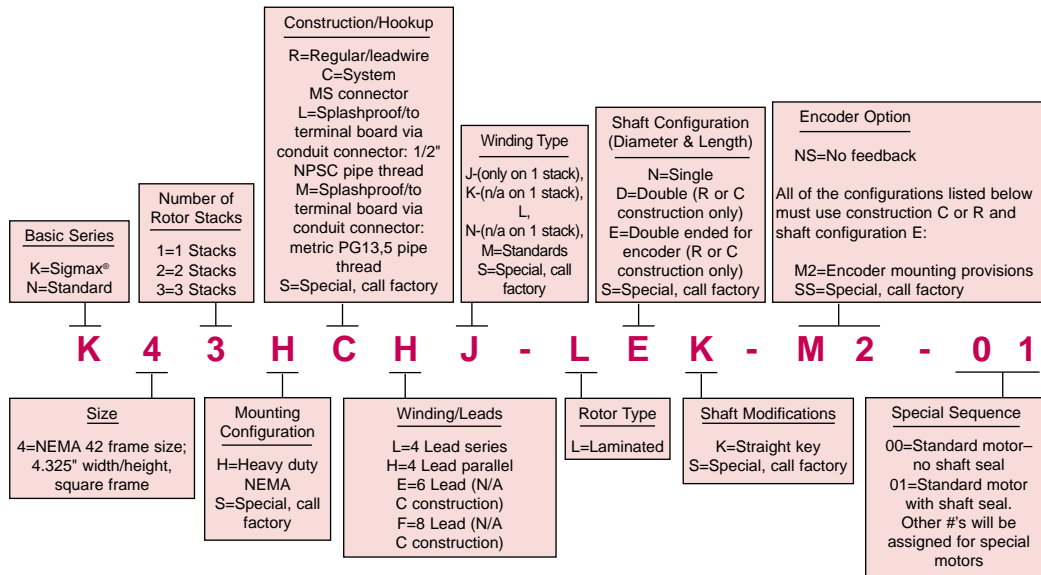

The example model number above indicates a K series (Sigmax®) NEMA 42 frame motor with a three stack rotor. This motor is equipped with a heavy duty front end bell and shaft, and a sealed system rear end bell with MS connectors. It also has a bipolar parallel connection, a J winding, a straight keyway, a shaft seal and encoder mounting provisions.

HOW TO ORDER

Review the Motor Model Number Code to assure that all options are designated. Call your nearest Pacific Scientific Motor Products Distributor to place orders and for application assistance. If you need to identify your Distributor, call the Motor Products Division at (815) 226-3100.

POWERPAC HYBRIDS

Also see:

- Torque and Acceleration Comparisons, p. 19, 29
- Torque Linearity, p. 29
- Performance Curves, p. 30-31

NEMA 42 FRAME (4.325" Square)—Ratings and Characteristics

Review the Model Number Code, page 25, to assure that all options are designated. Connections, encoders and phasing diagrams start on page 34. Motor dimensions start on page 32. In addition to those below, motors with characteristics for specific performance requirements are offered. Contact factory for more details.

Rated currents are in descending order	Motor Model Number [△]	Connection [△]		Holding Torque [△] (2 phases on) oz-in (Nm) ±10%	Rated Current/Phase [△] (amps DC)	Phase Resistance (ohms) ±10%	Phase Inductance [△] (mH) Typical	Detent Torque oz-in (Nm)	Thermal Resistance [△] (°C/watt)	Rotor Inertia oz-in-S ² (kgm ² x 10 ⁻³)	Weight lbs (kg)
		Parallel Series	Unipolar								
Torque range: 1480-2135 oz-in. 92.5-133.4 lb-in. 10.45-15.07 Nm	K41HXHM-LXK-XX-XX	•		2135(15.07)	10.7	0.16	2.2	↑	↑	↑	↑
	K41HXL M-LXK-XX-XX	•		2135(15.07)	5.3	0.63	8.7				
	K41HXEM-LXK-XX-XX		•	1510(10.66)	7.5	0.31	2.2				
K Series - SIGMAX® 1 rotor stack	K41HXHL-LXK-XX-XX	•		2090(14.75)	8.7	0.23	3.1	65 (0.46)	1.9	0.0783 (0.55)	11 (4.98)
	K41HXLL-LXK-XX-XX	•		2090(14.75)	4.4	0.93	12.3				
	K41HXEL-LXK-XX-XX		•	1480(10.45)	6.2	0.47	3.1				
	K41HXHJ-LXK-XX-XX	•		2095(14.79)	5.5	0.58	7.8				
	K41HXLJ-LXK-XX-XX	•		2095(14.79)	2.7	2.33	31.4				
	K41HXEJ-LXK-XX-XX		•	1480(10.45)	3.9	1.16	7.8				
Torque range: 1150-1655 oz-in. 78.1-103.4 lb-in. 8.12-11.68 Nm	N41HXHM-LXK-XX-XX	•		1655(11.68)	10.7	0.16	2.8	↑	↑	↑	↑
	N41HXL M-LXK-XX-XX	•		1655(11.68)	5.3	0.63	11.1				
	N41HXEM-LXK-XX-XX		•	1170(8.26)	7.5	0.31	2.8				
N Series - Standard 1 rotor stack	N41HXHL-LXK-XX-XX	•		1625(11.47)	8.7	0.23	3.9	42 (0.30)	1.9	0.0783 (0.55)	11 (4.98)
	N41HXLL-LXK-XX-XX	•		1625(11.47)	4.4	0.93	15.8				
	N41HXEL-LXK-XX-XX		•	1150(8.12)	6.2	0.47	3.9				
	N41HXHJ-LXK-XX-XX	•		1630(11.50)	5.5	0.58	10.1				
	N41HXLJ-LXK-XX-XX	•		1630(11.50)	2.7	2.33	40.4				
	N41HXEJ-LXK-XX-XX		•	1150(8.12)	3.9	1.16	10.1				

All ratings typical and at 25°C unless otherwise noted.

[△] An "X" in the Model Number Code indicates an undefined option. Colored letter indicates winding. See Model Number Code on page 25.

[△] Motor connections are determined by the Windings/Leads designation in the Model Number Code on page 25. Note that the F designation, although not shown in the above tables, is an 8-lead option...see Terminations, page 34. In addition to the lead wire termination, terminal board and MS connector hookup for parallel, series or unipolar operation is also available.

[△] With rated current applied. Windings at 130°C and motor unmounted and in still air at 40°C.

[△] Windings at 130°C and motor in still air at 40°C (without heat sink). Motors may be operated up to 2 times rated current to provide high peak torque with good torque linearity - **duty cycle dependant, contact factory.**

[△] Small signal inductance as measured with impedance bridge at 1kHz, 1 amp.

[△] Thermal resistance measured with motor hanging in still air (unmounted).

POWERPAC HYBRIDS

Also see:

- Torque and Acceleration Comparisons, p. 19, 29
- Torque Linearity, p. 29
- Performance Curves, p. 30-31

NEMA 42 FRAME (4.325" Square)—Ratings and Characteristics (Con't)

Review the Model Number Code, page 25, to assure that all options are designated. Connections, encoders and phasing diagrams start on page 34. Motor dimensions start on page 32. In addition to those below, motors with characteristics for specific performance requirements are offered. Contact factory for more details.

Rated currents are in descending order	Motor Model Number Δ	Connection Δ			Holding Torque Δ (2 phases on) oz-in (Nm) $\pm 10\%$	Rated Current/Phase Δ (amps DC)	Phase Resistance (ohms) $\pm 10\%$	Phase Inductance Δ (mH) Typical	Detent Torque oz-in (Nm)	Thermal Resistance Δ (°C/watt)	Rotor Inertia oz-in-S ² (kgm ² x 10 ⁻³)	Weight lbs (kg)
		Parallel	Series	Unipolar								
Torque range: 2785-4025 oz-in. 174.0-251.5 lb-in. 19.66-28.41 Nm	K42HXHN-LXK-XX-XX	•			4000(28.23)	15.8	0.1	1.6	↑	↑	↑	↑
	K42HXLN-LXK-XX-XX	•			4000(28.23)	7.9	0.41	6.5				
	K42HXEN-LXK-XX-XX		•		2830(19.97)	11.2	0.21	1.6				
K Series - SIGMAX® 2 rotor stacks	K42HXHM-LXK-XX-XX	•			4025(28.41)	9.9	0.25	4.2	126 (0.89)	1.3	0.1546 (1.09)	18.4 (8.34)
	K42HXLN-LXK-XX-XX	•			4025(28.41)	4.9	1.02	16.9				
	K42HXEM-LXK-XX-XX		•		2845(20.08)	7	0.51	4.2				
	K42HXHL-LXK-XX-XX	•			3935(27.77)	8.1	0.38	6				
	K42HXLN-LXK-XX-XX	•			3935(27.77)	4	1.51	23.9				
	K42HXEL-LXK-XX-XX		•		2785(19.66)	5.7	0.75	6				
N Series - Standard 2 rotor stacks	K42HXHK-LXK-XX-XX	•			3965(27.99)	6.4	0.6	9.8	↓	↓	↓	↓
	K42HXLN-LXK-XX-XX	•			3965(27.99)	3.2	2.41	39.2				
	K42HXEK-LXK-XX-XX		•		2805(19.80)	4.5	1.2	9.8				
	N42HXHN-LXK-XX-XX	•			3130(22.09)	15.8	0.1	2.1				
	N42HXLN-LXK-XX-XX	•			3130(22.09)	7.9	0.41	8.4				
	N42HXEN-LXK-XX-XX		•		2215(15.63)	11.2	0.21	2.1				
N Series - Standard 2 rotor stacks	N42HXHM-LXK-XX-XX	•			3145(22.20)	9.9	0.25	5.5	84 (0.59)	1.3	0.1546 (1.09)	18.4 (8.34)
	N42HXLN-LXK-XX-XX	•			3145(22.20)	4.9	1.02	22				
	N42HXEM-LXK-XX-XX		•		2225(15.70)	7	0.51	5.5				
	N42HXHL-LXK-XX-XX	•			3085(21.77)	8.1	0.38	7.8				
	N42HXLN-LXK-XX-XX	•			3085(21.77)	4	1.51	31.2				
	N42HXEL-LXK-XX-XX		•		2185(15.42)	5.7	0.75	7.8				
	N42HXHK-LXK-XX-XX	•			3105(21.92)	6.4	0.6	12.8	↓	↓	↓	↓
	N42HXLN-LXK-XX-XX	•			3105(21.92)	3.2	2.41	51.1				
	N42HXEK-LXK-XX-XX		•		2200(15.53)	4.5	1.2	12.8				

All ratings typical and at 25°C unless otherwise noted.

- Δ An "X" in the Model Number Code indicates an undefined option. Colored letter indicates winding. See Model Number Code on page 25.
- Δ Motor connections are determined by the Windings/Leads designation in the Model Number Code on page 25. Note that the F designation, although not shown in the above tables, is an 8-lead option...see Terminations, page 34. In addition to the lead wire termination, terminal board and MS connector hookup for parallel, series or unipolar operation is also available.

- Δ With rated current applied. Windings at 130°C and motor unmounted and in still air at 40°C.
- Δ Windings at 130°C and motor in still air at 40°C (without heat sink). Motors may be operated up to 2 times rated current to provide high peak torque with good torque linearity - **duty cycle dependant, contact factory.**
- Δ Small signal inductance as measured with impedance bridge at 1kHz, 1 amp.
- Δ Thermal resistance measured with motor hanging in still air (unmounted).

POWERPAC HYBRIDS

Also see:

- Torque and Acceleration Comparisons, p. 19, 29
- Torque Linearity, p. 29
- Performance Curves, p. 30-31

NEMA 42 FRAME (4.325" Square)—Ratings and Characteristics (Con't)

Review the Model Number Code, page 25, to assure that all options are designated. Connections, encoders and phasing diagrams start on page 34. Motor dimensions start on page 32. In addition to those below, motors with characteristics for specific performance requirements are offered. Contact factory for more details.

Rated currents are in descending order	Motor Model Number Δ	Connection Δ			Holding Torque Δ (2 phases on) oz-in (Nm) $\pm 10\%$	Rated Current/ Phase Δ (amps DC)	Phase Resistance (ohms) $\pm 10\%$	Phase Inductance Δ (mH) Typical	Detent Torque oz-in (Nm)	Thermal Resistance Δ ($^{\circ}\text{C}/\text{watt}$)	Rotor Inertia oz-in-S ² (kgm ² x 10 ⁻³)	Weight lbs (kg)					
		Parallel	Series	Unipolar													
Torque range: 3910-5700 oz-in. 244.3-356.0 lb-in. 27.60-40.23 Nm	K43HXHN-LXK-XX-XX	•			5700 (40.23)	15.4	0.14	2.5	↑	↑	↑	↑					
	K43HXLN-LXK-XX-XX	•			5700 (40.23)	7.7	0.55	10									
	K43HXEN-LXK-XX-XX	•			4030 (28.44)	10.9	0.28	2.5									
	<hr/>																
	K Series - SIGMAX® 3 rotor stacks	K43HXHM-LXK-XX-XX	•			5630 (39.74)	9.9	0.33					5.9				
		K43HXLN-LXK-XX-XX	•			5630 (39.74)	4.9	1.32					23.7				
		K43HXEM-LXK-XX-XX	•			3985 (28.13)	7	0.66					5.9				
		<hr/>															
		K43HXHL-LXK-XX-XX	•			5530 (39.03)	8	0.5					8.5				
K43HXLL-LXK-XX-XX		•			5530 (39.03)	4	1.98	34.1									
K43HXEL-LXK-XX-XX		•			3910 (27.60)	5.7	0.99	8.5									
<hr/>																	
K43HXHK-LXK-XX-XX		•			5655 (39.91)	6.2	0.82	15.2									
K43HXLK-LXK-XX-XX	•			5655 (39.91)	3.1	3.29	60.7										
K43HXEK-LXK-XX-XX	•			4000 (28.23)	4.4	1.65	15.2										
<hr/>																	
Torque range: 3010-4365 oz-in. 188.1-272.8 lb-in. 21.24-30.81 Nm	N43HXHN-LXK-XX-XX	•			4365 (30.81)	15.4	0.14	3.2	↑	↑	↑	↑					
	N43HXLN-LXK-XX-XX	•			4365 (30.81)	7.7	0.55	13									
	N43HXEN-LXK-XX-XX	•			3090 (21.81)	10.9	0.28	3.2									
	<hr/>																
	N Series - Standard 3 rotor stacks	N43HXHM-LXK-XX-XX	•			4320 (30.49)	9.9	0.33					7.7				
		N43HXLN-LXK-XX-XX	•			4320 (30.49)	4.9	1.32					30.7				
		N43HXEM-LXK-XX-XX	•			3055 (21.56)	7	0.66					7.7				
		<hr/>															
		N43HXHL-LXK-XX-XX	•			4250 (30.00)	8	0.5					11				
N43HXLL-LXK-XX-XX		•			4250 (30.00)	4	1.98	44.2									
N43HXEL-LXK-XX-XX		•			3010 (21.24)	5.7	0.99	11									
<hr/>																	
N43HXHK-LXK-XX-XX		•			4340 (30.63)	6.2	0.82	19.6									
N43HXLK-LXK-XX-XX	•			4340 (30.63)	3.1	3.29	78.5										
N43HXEK-LXK-XX-XX	•			3070 (21.67)	4.4	1.65	19.6										

All ratings typical and at 25°C unless otherwise noted.

Δ An "X" in the Model Number Code indicates an undefined option. Colored letter indicates winding. See Model Number Code on page 25.

Δ Motor connections are determined by the Windings/Leads designation in the Model Number Code on page 25. Note that the F designation, although not shown in the above tables, is an 8-lead option...see Terminations, page 34. In addition to the lead wire termination, terminal board and MS connector hookup for parallel, series or unipolar operation is also available.

Δ With rated current applied. Windings at 130°C and motor unmounted and in still air at 40°C.

Δ Windings at 130°C and motor in still air at 40°C (without heat sink). Motors may be operated up to 2 times rated current to provide high peak torque with good torque linearity - **duty cycle dependant, contact factory.**

Δ Small signal inductance as measured with impedance bridge at 1kHz, 1 amp.

Δ Thermal resistance measured with motor hanging in still air (unmounted).

POWERPAC HYBRIDS

NEMA 42 FRAME (4.325" Square)—Torque and Acceleration Comparisons

For comparison with size 34 motor, see page 19.

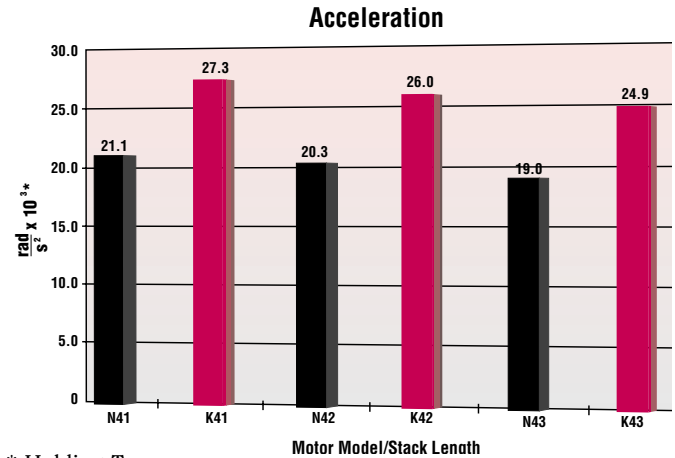
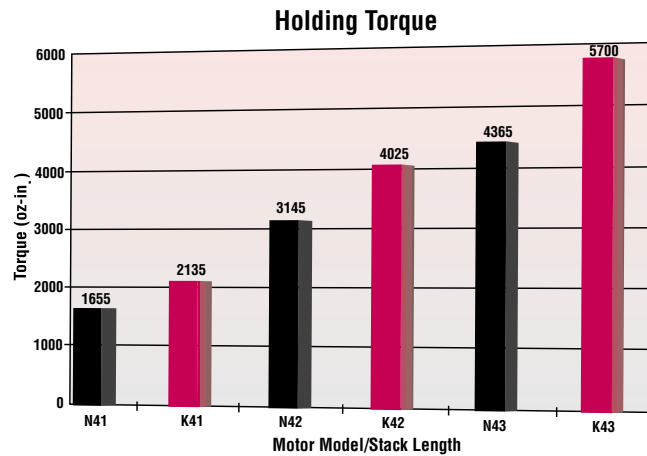

* $\frac{\text{Holding Torque}}{\text{Rotor Inertia}}$...a figure of merit for acceleration capability

NEMA 42 FRAME (4.325" Square)—Torque Linearity

A significant POWERPAC performance attribute is that when a current higher than rated current is applied, the increase in torque will be more linear than other hybrids. Furthermore, current levels increasingly higher than rated current are less likely to cause demagnetization. Capitalize on this performance characteristic which will provide an acceleration boost to move loads even faster. This technique is applicable to intermittent duty applications in that the thermal limit of the motor cannot be exceeded. Driving the motor at higher than rated current is duty cycle dependent. Contact the factory for application assistance.

These curves show the torque at rated current and the torque linearity up to two times rated current.

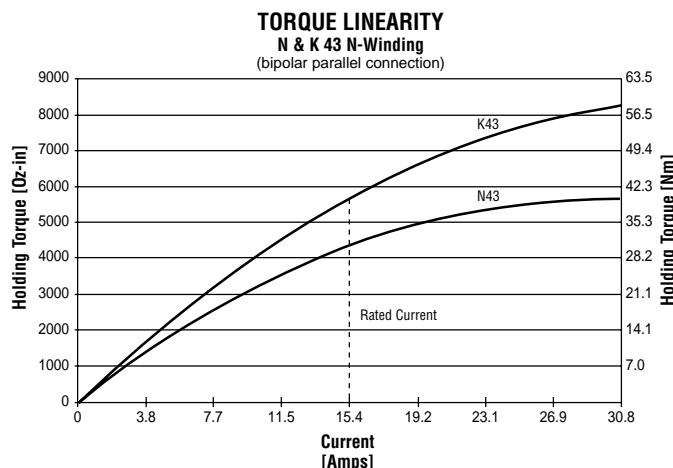
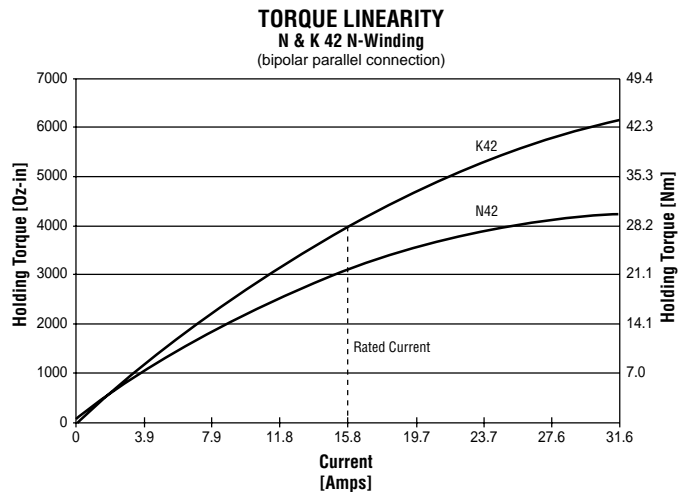
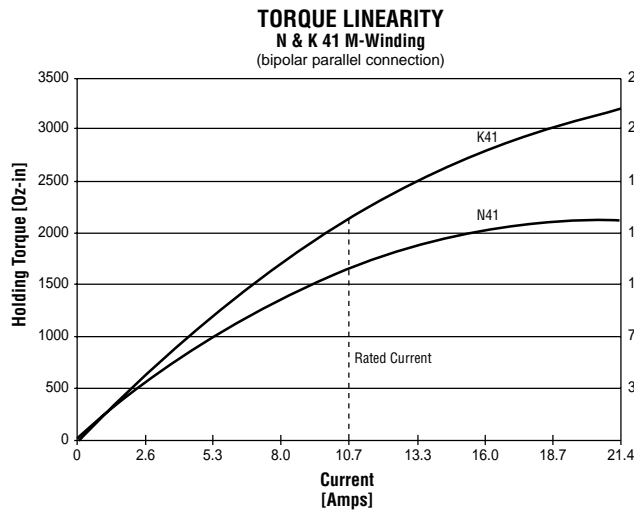

POWERPAC HYBRIDS

NEMA 42 FRAME (4.325" Square)—Performance

Motors will perform continuously as shown without the winding temperature exceeding 130°C when the motor is operated (without heat sink) in an ambient temperature of up to 40°C. The curves do not reflect system resonance points, which will vary with motor coupling and system parameters.

NEMA 42 FRAME – ONE ROTOR STACK

5A per phase; K41* and N41*

J winding, parallel connection, See Ratings and Characteristics, p. 26.

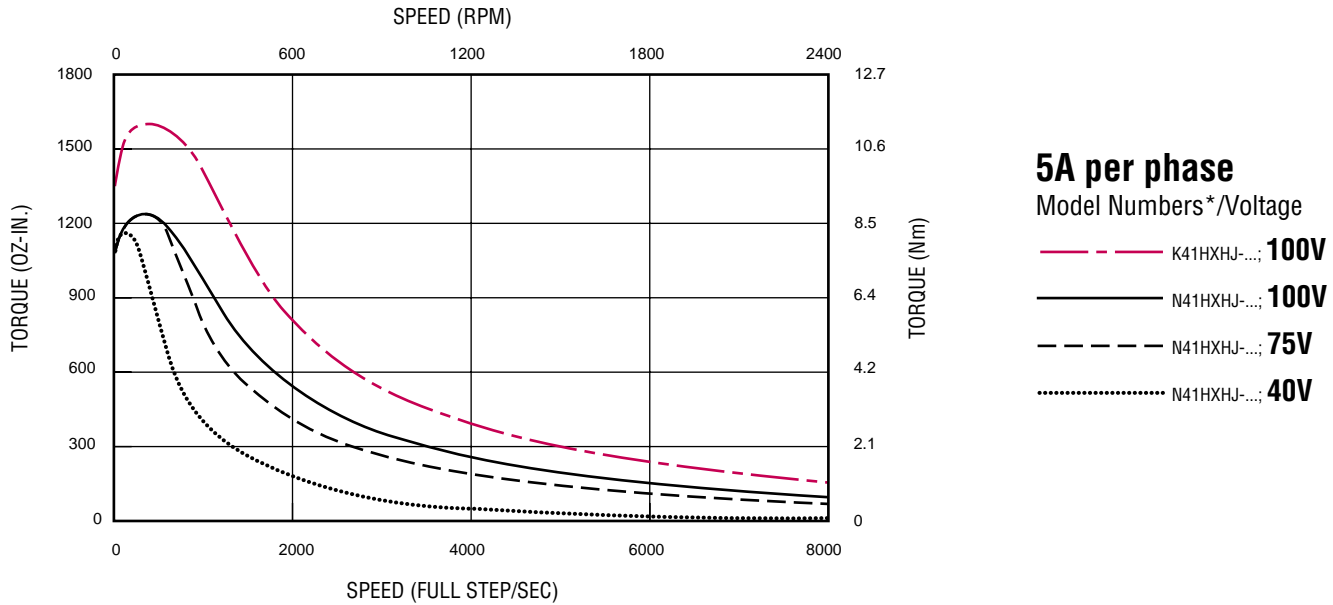

NEMA 42 FRAME – TWO ROTOR STACKS

8A per phase; K42* and N42*

L winding, parallel connection, See Ratings and Characteristics, p. 27.

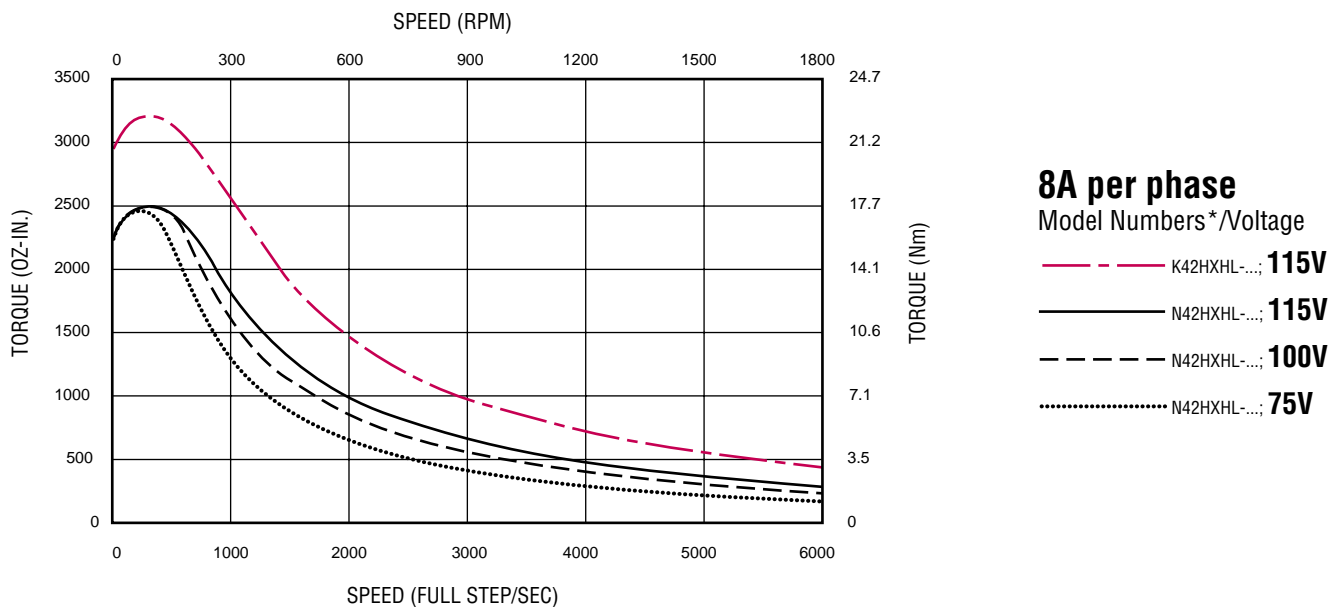

*See Model Number Code on page 25 for clarification.

POWERPAC HYBRIDS

NEMA 42 FRAME (4.325" Square)—Performance

Motors will perform continuously as shown without the winding temperature exceeding 130°C when the motor is operated (without heat sink) in an ambient temperature of up to 40°C. The curves do not reflect system resonance points, which will vary with motor coupling and system parameters.

NEMA 42 FRAME – THREE ROTOR STACKS

8A per phase; K43* and N43*

L winding, parallel connection, See Ratings and Characteristics, p. 28.

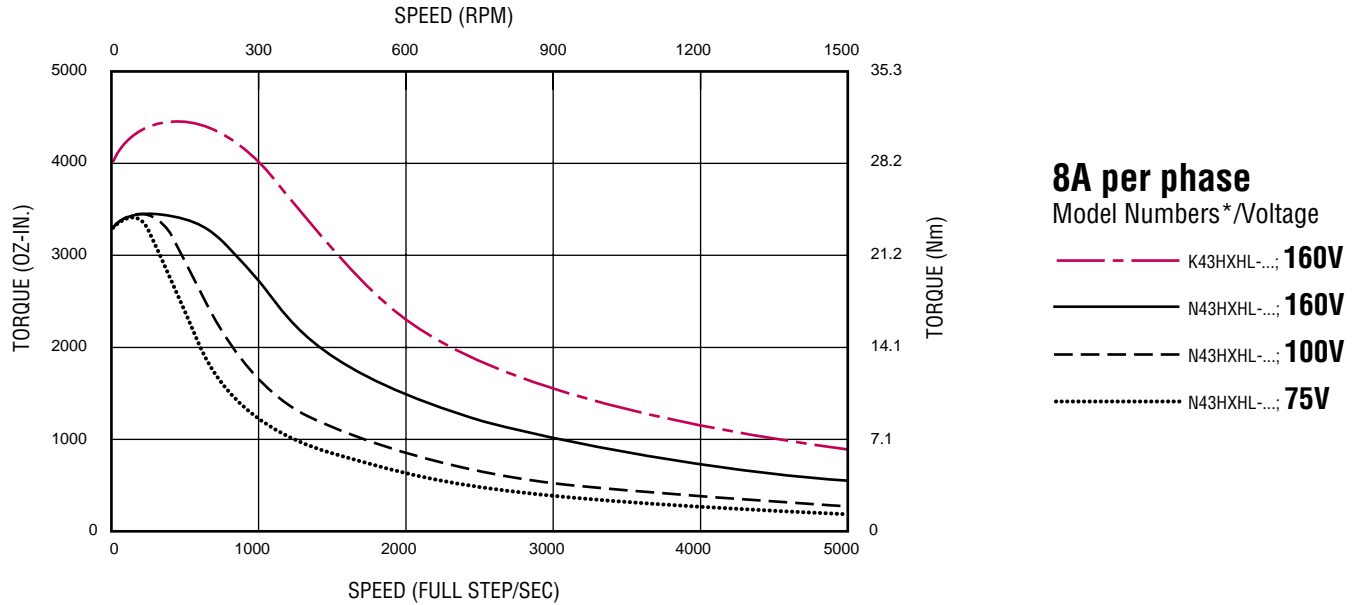

*See Model Number Code on page 25 for clarification.

DIMENSIONS . . . POWERPAC HYBRIDS

in. (metric dimensions for ref. only)
mm

NEMA 42 FRAME: All motors have a heavy duty NEMA front end bell and large diameter shaft to support the higher output torques

LEADWIRE HOOKUP

Model Number Code designation R (Construction/Hookup), p. 25.

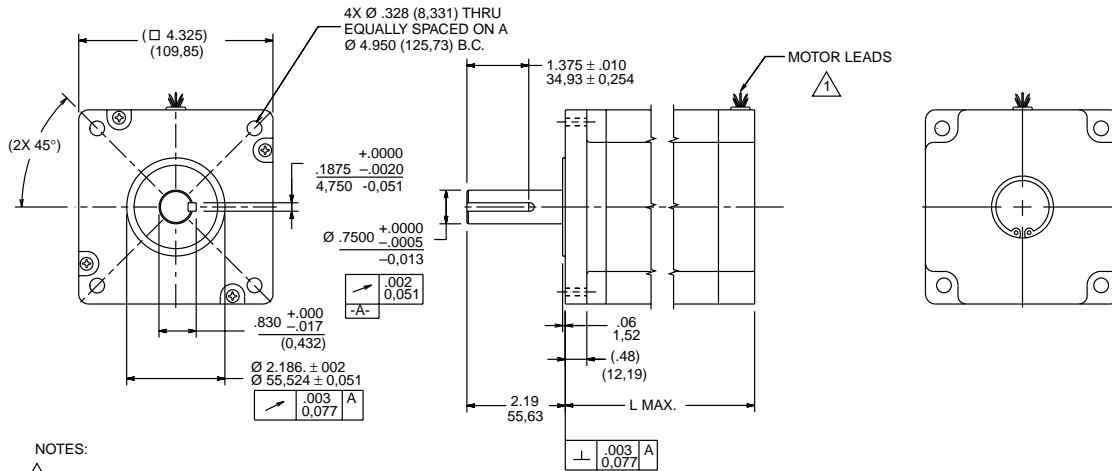

NOTES:
1 MOTOR LEADS 12.0 MIN.

MOTOR	L MAX
41 HR	3.89 98.81
42 HR	5.91 150.11
43 HR	7.92 201.17

* See Model Number Code, p. 25.

LEADWIRE HOOKUP DOUBLE SHAFT CONFIGURATION

Model Number Code designation D (Shaft Configuration), p. 25.
Available on R construction only.

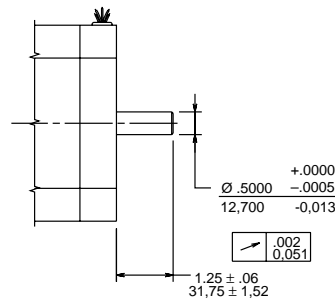

LEADWIRE HOOKUP ENCODER MOUNTING PROVISION

Model Number Code designation M2
(Encoder Mounting Option), p. 25.

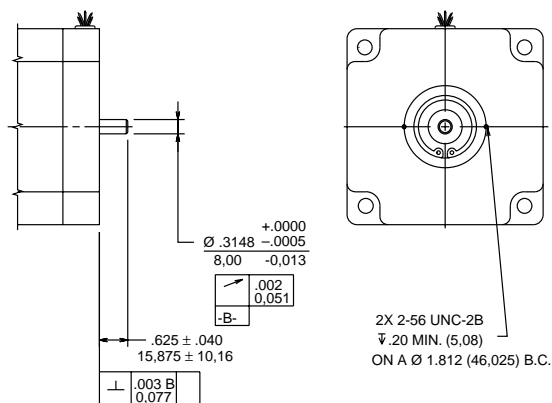

DIMENSIONS . . . POWERPAC HYBRIDS

in. (metric dimensions for ref. only)
mm

NEMA 42 FRAME: All motors have a heavy duty NEMA front end bell and large diameter shaft to support the higher output torques

SPLASHPROOF CONSTRUCTION/TERMINAL BOARD CONNECTIONS

(via English or Metric thread for conduit) Model Number Code designation L or M (Construction/Hookup), p. 25

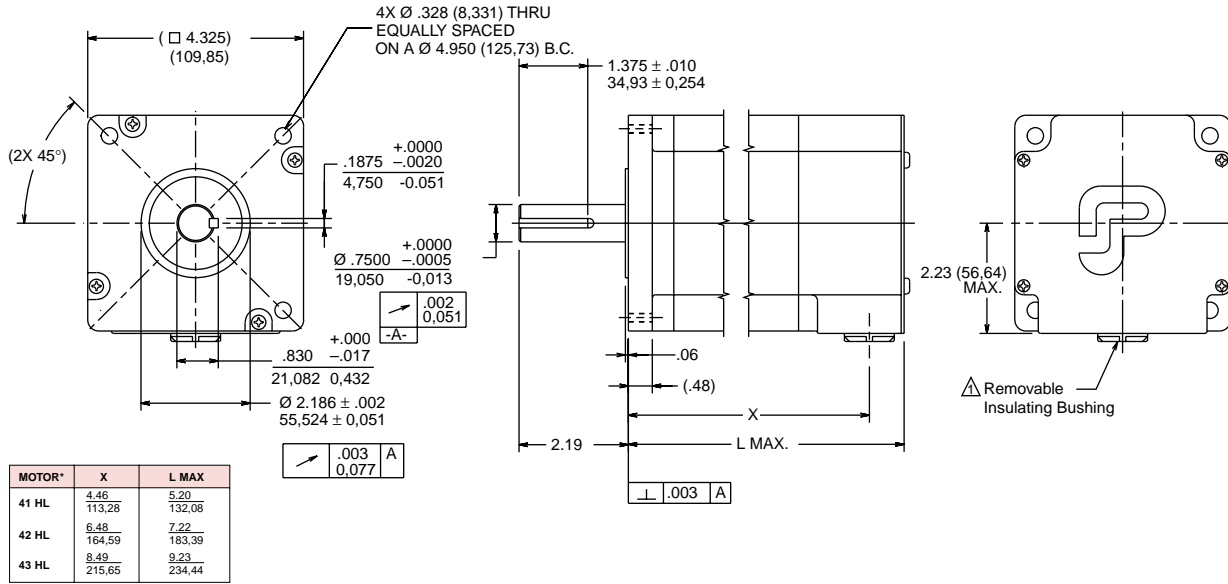

SPLASHPROOF CONSTRUCTION/MS CONNECTOR(S)— ENCODER OPTION

Model Number Code designation C/System (Construction/Hookup) and Encoder Mounting Option, p. 25.

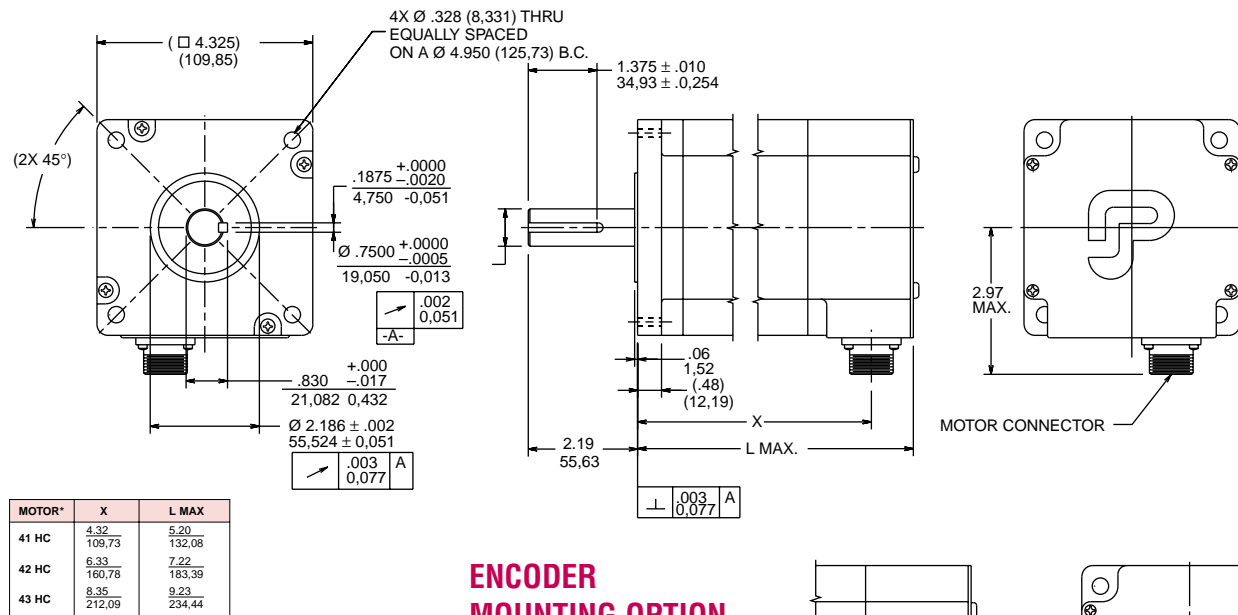

ENCODER MOUNTING OPTION

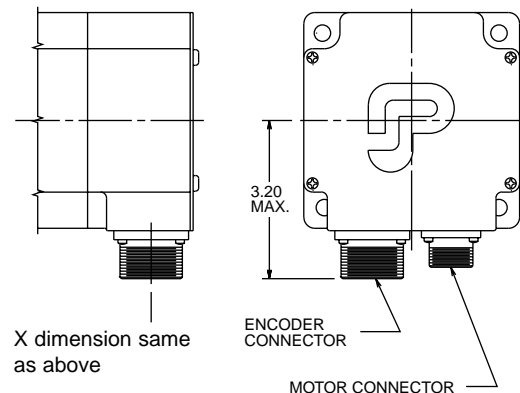

NOTES:

△ L Construction = Conduit connection (1/2 NPSC TAP) with $\frac{56}{14,2}$ I.D. removable insulating bushing

M Construction = Conduit connection (PG 13, 5 TAP). (No insulating bushing supplied)

POWERPAC™ HYBRID TECHNICAL DATA

- Hybrid motor power connections
- Phase sequencing tables
- Encoder options

HYBRID MOTOR POWER CONNECTIONS

FLYING LEADS, TERMINAL BOARD OR MS CONNECTOR

Four winding designations; F, E, L or H may be specified in the Model Number Code. For all motor terminations, refer to the step motor controller connection diagram to assure that proper connections are made. Consult our application engineers for assistance if necessary.

DESIGNATION F . . . 8 flying leads or 8 terminals (not available in systems construction - MS connector)

The 8 lead motor is the most versatile configuration. It may be connected by the user in choice of 8 lead, 4 lead (series or parallel) or 6 lead configuration.

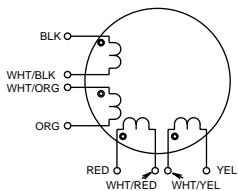

8-Lead Configuration

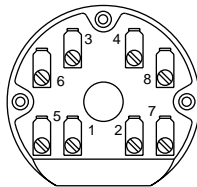

Terminal Board
NEMA 34 and 42

CONNECTION	DRIVER CONNECTION	LEAD COLOR	TERMINAL #
4-LEAD BIPOLAR SERIES	A	BLACK (BLK)	1
	\bar{A}	ORANGE (ORG)	3
	B	RED	2
	\bar{B}	YELLOW (YEL)	4
	NONE	WHT/BLK & WHT/ORG	6 & 5
	NONE	WHT/RED & WHT/YEL	8 & 7
4-LEAD BIPOLAR PARALLEL	A	BLK & WHT/ORG	1 & 5
	\bar{A}	ORG & WHT/BLK	3 & 6
	B	RED & WHT/YEL	2 & 7
	\bar{B}	YEL & WHT/RED	4 & 8
6-LEAD UNIPOLAR	A	BLACK (BLK)	1
	B	ORANGE (ORG)	3
	C	RED	2
	D	YELLOW (YEL)	4
	+V	WHT/BLK & WHT/ORG	6 & 5
	+V	WHT/RED & WHT/YEL	8 & 7
GND		GREEN/YELLOW	

NOTE:

1. See phase sequencing tables, page 36.

DESIGNATION E . . . 6 flying leads or 6 terminals (not available in systems construction - MS connector)

The 6 lead motor is normally used with unipolar drives. In some cases, the 6 lead motor can be used in a 4 lead series configuration for use with bipolar drives.

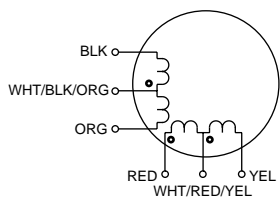

6-Lead Configuration

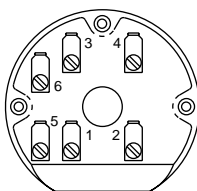

Terminal Board
NEMA 34 and 42

CONNECTION	DRIVER CONNECTION	LEAD COLOR	TERMINAL #
6-LEAD UNIPOLAR	A	BLACK (BLK)	1
	B	ORANGE (ORG)	3
	C	RED	2
	D	YELLOW (YEL)	4
	+V	WHT/BLK/ORG	5
	+V	WHT/RED/YEL	6
4-LEAD BIPOLAR SERIES	A	BLACK (BLK)	1
	\bar{A}	ORANGE (ORG)	3
	B	RED	2
	\bar{B}	YELLOW (YEL)	4
	NONE	WHT/BLK/ORG	5
	NONE	WHT/RED/YEL	6
GND		GREEN/YELLOW	

NOTE:

1. Terminals 7 and 8 are not used.
2. See phase sequencing tables, page 36.

DESIGNATION L or H . . . 4 flying leads, 4 terminals or MS connector

The 4 lead motor is for use with bipolar drives.

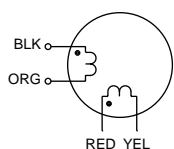

4-Lead Configuration

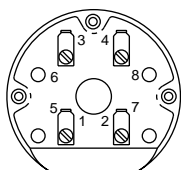

Terminal Board

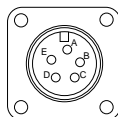

MS Connector
NEMA 34 and 42

CONNECTION	DRIVER CONNECTION	LEAD COLOR	TERMINAL #	MS PIN OUT
4-LEAD BIPOLAR	A	BLACK	1	A
	\bar{A}	ORANGE	3	B
	B	RED	2	C
	\bar{B}	YELLOW	4	D
GND		GREEN/YELLOW		E

MOTOR POWER CONNECTOR
NEMA 34 & 42
MS3102R14S-5P

SUGGESTED MATING CONNECTOR	
NEMA 34 & 42	PAC SCI P.N.
MS3106F14S-5S	SZ00019

NOTE:

1. Terminals 5, 6, 7 and 8 are not used.
2. See phase sequencing tables, page 36.

PHASE SEQUENCING TABLES

NOTE: Direction of rotation as viewed from mounting end of motor.

DRIVER CONNECTION

STEP	A	\bar{A}	B	\bar{B}
1	+	-	0	0
2	+	-	+	-
3	0	0	+	-
4	-	+	+	-
5	-	+	0	0
6	-	+	-	+
7	0	0	-	+
8	+	-	-	+

BIPOLAR HALF STEP PHASE SEQUENCING

DRIVER CONNECTION

STEP	A	\bar{A}	B	\bar{B}
1	+	-	-	+
2	-	+	-	+
3	-	+	+	-
4	+	-	+	-
1	+	-	-	+

BIPOLAR FULL STEP PHASE SEQUENCING

DRIVER CONNECTION

STEP	A	B	C	D
1	GND	0	GND	0
2	0	GND	GND	0
3	0	GND	0	GND
4	GND	0	0	GND
1	GND	0	GND	0

UNIPOLAR FULL STEP PHASE SEQUENCING

- NOTES:
- 0 = OFF OR OPEN.
 - + = POSITIVE CURRENT FLOW.
 - = NEGATIVE CURRENT FLOW.

ENCODER OPTIONS

NEMA 34 AND NEMA 42 ENCODER MOUNTING OPTIONS

Encoder mounting options factory installed (inside).
See NEMA 34 drawing, p. 24 and
NEMA 42 drawing, p. 33.

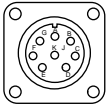

ENCODER CONNECTOR

PIN	FUNCTION
A	CHANNEL A
B	CHANNEL \bar{A}
C	CHANNEL B
D	CHANNEL \bar{B}
E	CHANNEL Z
F	CHANNEL \bar{Z}
G	+ 5 VDC
H	5 VDC RTN

MOTOR FEEDBACK CONNECTOR
CA3102E20-7P-A206-F80-FO

SUGGESTED MATING CONNECTOR	
PAC SCI P.N. CZ00008	CANNON P.N. MS3106A20-7S-621

SHAFT LOAD AND BEARING FATIGUE LIFE (L_{10})

The POWERPAC H-mount configuration has a heavy duty NEMA front end bell and a large diameter shaft to support the higher torque outputs.

Bearings are the only wearing component in a step motor. PacSci uses heavy duty, long life bearings to assure you the maximum useful life from every step motor you purchase.

SHAFT LOADING

The maximum radial fatigue load ratings reflect the following assumptions:

1. Motors are operated at 1 * K Series torque
2. Fully reversed radial load applied in the center of the keyway extension
3. Infinite life with 99% reliability
4. Safety factory = 2

Motor*	Max. Radial Force (Lb.)	Max. Axial Force (Lb.)
31, 32	65	305
33, 34	110	305
41	125	404
42, 43	110	404

* Applies to both the K and N Series. See Model Number Codes on pages 14 and 25 for clarification.

BEARING FATIGUE LIFE (L_{10}) Applies to both K and N Series. See Model Number Codes on pages 14 and 25 for clarification.
 Note: SPS = Speed, Full Steps Per Second

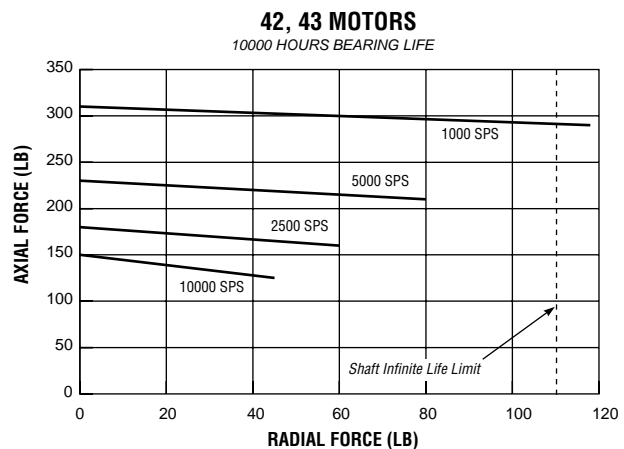
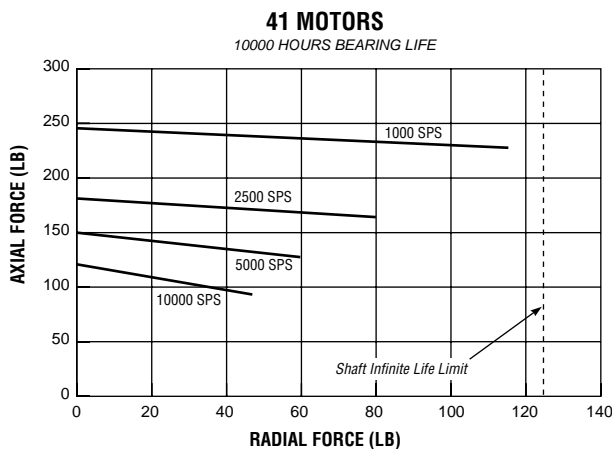
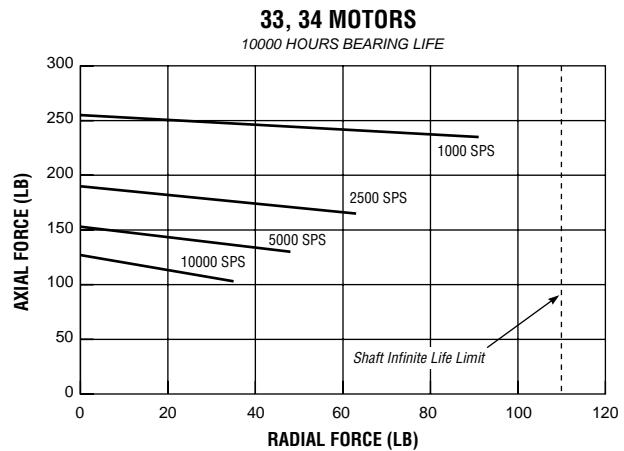
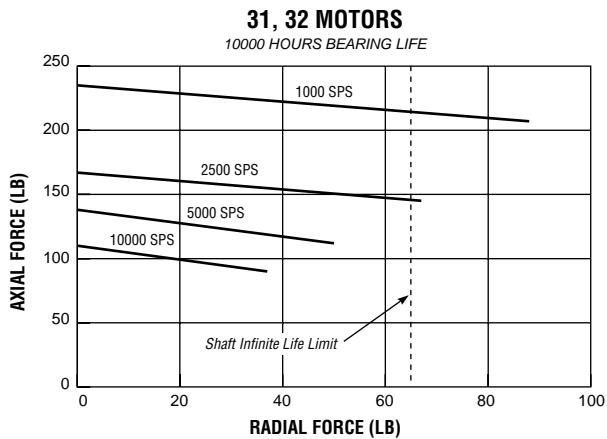

POWERMAX II®



POWERMAX II® sets the world performance standard for NEMA 23 step motors. At up to 253 oz-in. holding torque, you won't find a more powerful two inch stepper.

With POWERMAX II you also gain the cost advantages of design for manufacturability (DFM) and North America's most advanced step motor manufacturing line.

That makes POWERMAX II economical without sacrificing features - such as long life bearings, high temperature insulation and quality magnet materials.

Plus DFM means we can build POWERMAX II to your specifications, in the volumes you need, according to your JIT or other delivery schedule.

Standard

Standard POWERMAX II motors come in half, single and two stacks that provide holding torques from 42 to 253 oz-in.

Custom

POWERMAX II proves that an economical step motor doesn't have to limit your options. It's just the opposite, thanks to flexible manufacturing.

Whether you require a simple drive shaft flat or an integral lead screw, POWERMAX II motors are made to order.

FEATURES

Two Year Warranty

New Polymer Encapsulated Stator

New Polymer End Bell with Threaded Inserts

Largest Available Shaft Diameter on a NEMA 23 Stepper

Oversized 30mm Bearings

Sigma[®] Technology

Optional Low Inertia Rotor

Optional Solid Rotor

Precision Ground Rotor OD and Honed Stator ID for Concentric Air Gap in an Economical Motor Design

Exposed Laminations Aids Thermal Dissipation

High Performance Gearheads



BENEFITS

High quality, dependable operation

Exceptional thermal dissipation

End bell runs cooler, provides greater flexibility in mounting encoder and brake options

Withstands high radial and axial loads. Supports numerous shaft modifications.

Increases bearing fatigue life (L_{10}), extends motor life, reduces downtime

Increases available torque

Produces the highest acceleration rate possible

High low speed torque, fast settling, superior stiffness and damping

High quality performance in an economical motor design.

Improved heat dissipation extends motor life, reduces downtime.

Increases torque range in a reliable, complete package

POWERMAX II®

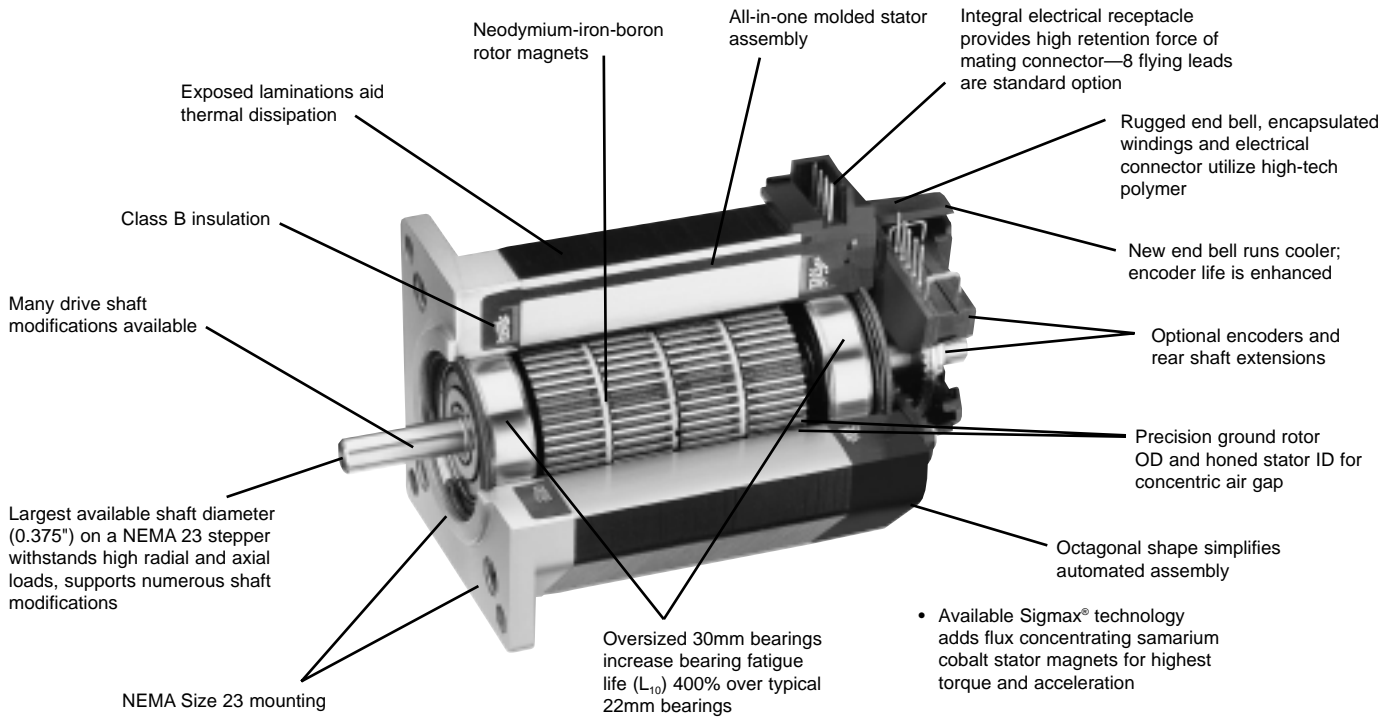

MODEL NUMBER CODE POWERMAX II® motors

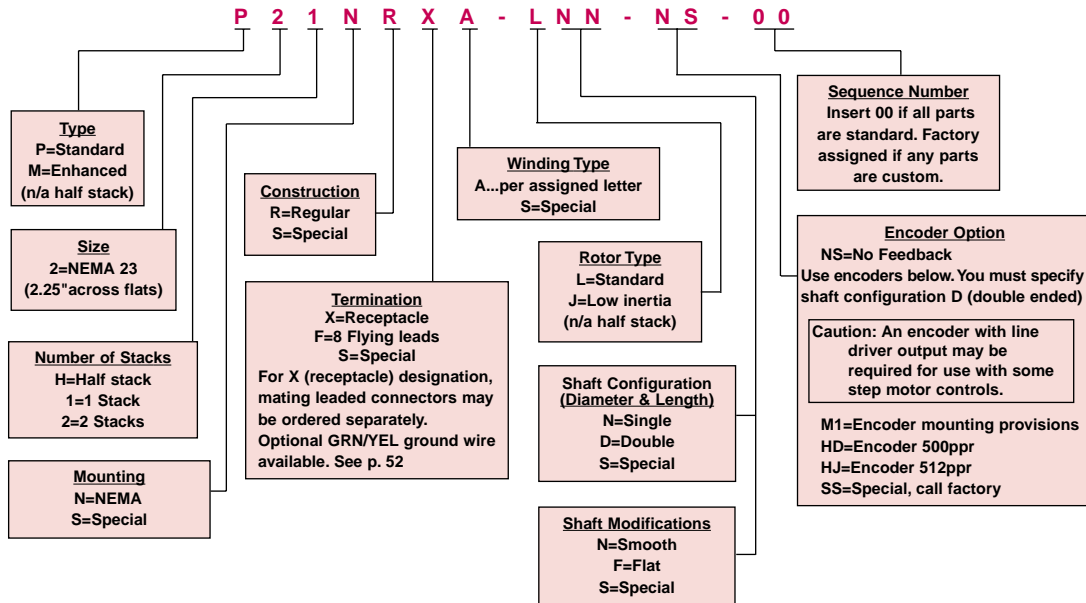

The example model number above indicates a standard NEMA 23 frame motor with a one stack rotor. This motor is equipped with a standard NEMA mount, regular construction, receptacle and an A winding. It also has a standard rotor, a smooth single-ended shaft and no encoder or encoder mounting provisions.

HOW TO ORDER

Review the Motor Model Number Code to assure that all options are designated. Dimensions, connections and phasing diagrams start on page 49. Encoder mounting options are on page 53.

POWERMAX II® INDEX

How to use this section

This section covers our high performance NEMA 23 frame POWERMAX II® hybrid stepper motors.

- If you're new to POWERMAX II and PacSci we'd recommend you review the Application Assistance section on pages 6 - 9.

- If you're familiar with POWERMAX II you can use the index at right to quickly locate the information you need for your application.

Technical overview Pages 41-44

- Cost/performance
- Comparison of standard and Sigmax® enhanced hybrid technologies
- Technical specifications

Rating and characteristics Pages 45-47

- Model number code
- P Series standard hybrids: 1/2, 1 and 2 stacks
- M Series Sigmax® hybrids: 1 and 2 stacks
- Holding torque range: 42 to 253 oz-in.
- 72 standard models with laminated rotors
- Low inertia rotors for highest acceleration rates: 12 standard models

Dimensions Page 49

- Dimensional drawings
- Shaft details and options
- See illustrated examples of additional standard options on page 49

Connection information Pages 49, 50

- Terminations
- Phase sequencing
- Bipolar and unipolar windings
- Optional leaded connectors
- Optional mating connectors
- See illustrated examples of optional connectors on page 52

Encoder options Page 53

- Agilent Technologies HEDS 5600 Series
 - Dimensional drawings
 - Mounting provisions
 - See illustrated examples of encoder options on page 53
-

POWERMAX II HYBRIDS SELECTION OVERVIEW

POWERMAX II® HYBRIDS

		NEMA 23	
		(2.3" square frame)	
		Holding torque range	
		oz-in. (Nm)	Page
M Series – Sigmax® Technology			
	1 Stack	95-144 (0.67-1.02)	46
	2 Stacks	161-253 (1.13-1.79)	47
P Series – Standard Hybrid			
	1/2 Stack	42-61 (0.29-0.43)	45
	1 Stack	77-116 (0.54-0.82)	46
	2 Stacks	138-214 (0.97-1.51)	47
M “J” Series - Sigmax Technology - Low Inertia Rotor			
	1 Stack	99-140 (0.70-0.99)	48
	2 Stacks	178-252 (1.26-1.78)	48
P “J” Series - Sigmax Hybrid - Low Inertia Rotor			
	1 Stack	79-111 (0.55-0.78)	48
	2 Stacks	142-201 (1.00-1.42)	48

POWERMAX II® GIVES YOU OPTIONS

POWERMAX II® proves that an economical step motor doesn't have to limit your options. It's just the opposite, thanks to flexible manufacturing.

Whether you require a simple drive shaft flat or an integral lead screw, POWERMAX II motors are made to your order.

To give us your specifications, just use the guide on page 6 - 9 of this catalog.

Standard Motor

Clockwise from right: POWERMAX II motors come in half, single and double rotor stacks in holding torques from 42 to 253 oz-in.

Typical modifications

Large diameter drive shaft

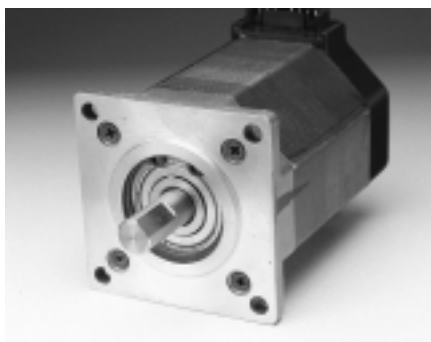

POWERMAX II offers the largest diameter (0.375") drive shaft available in a NEMA 23 step motor.



Large diameter drive shaft with flat withstands high radial and axial loads, supports numerous shaft modifications.



Large diameter drive shaft with special flat.

Popular flats

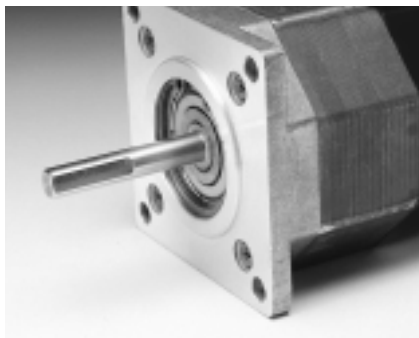

Extended length drive shaft with flat.



Two flats on drive shaft permit use of dual setscrews for increased locking force.



Flat extending full length of long drive shaft for secure engagement.



Drive shaft modifications

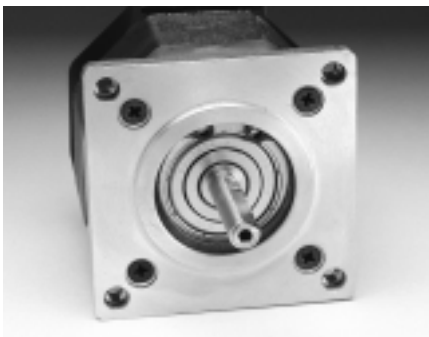

Internal threaded, drive shaft. Flat. Threaded mounting inserts in front end cap.



Cross-drilled shaft accepts hardened roll pin to attach sleeves, pulleys and gears.



Slotted drive shaft permits screwdriver adjustment for applications requiring manual shaft positioning. Flat on shaft.



Extended, stepped down shaft machined as two mating parts.

www.pacsci.com

Drive shaft add-ons



Hardened steel gear extension press-fitted to drive shaft.

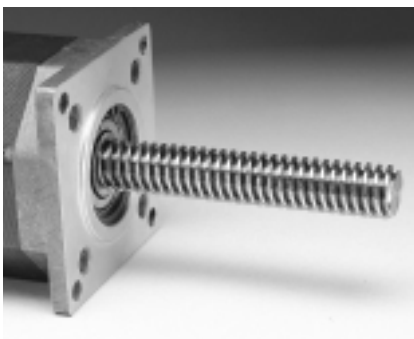

Acme lead screw fixed to drive shaft.



Helical gear press-fitted to drive shaft.



Plastic gear with brass bushing attached by hardened roll pin through cross-drilled hole in shaft.

Encoder options



Encoder-ready rear shaft extension and mounting provision (1.812" bolt circle) accepts popular encoders.

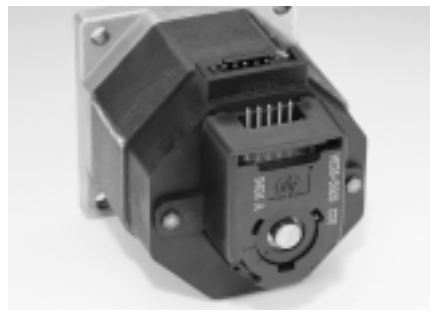

Agilent Technologies HEDS 5600 encoder (without line driver outputs) mounted on rear shaft extension and end cap.

POWERMAX II® MOTOR TECHNOLOGY

Pacific Scientific developed POWERMAX II® to be the best cost/performance value available in hybrid step motors.

That's why you'll find so many standard POWERMAX II models in the universal NEMA 23 frame size. With POWERMAX II, you can tailor motor torque, acceleration and inertia to every axis of your design. And you can do this economically too, using a single mounting configuration and the driver of your choice.

Does your application require that extra measure of performance? Then consider the POWERMAX II M Series, featuring the patented Sigmax® technology.*

Samarium cobalt magnets in M Series motors concentrate magnetic flux at desired points between the rotor and stator. Sigmax technology optimizes flux paths to increase torque production and current utilization over conventional hybrid designs.

P SERIES STANDARD HYBRID

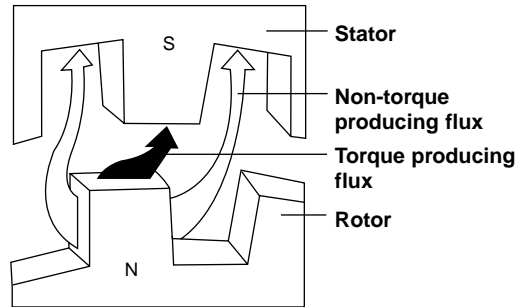

Typical paths of flux transfer in an energized conventional hybrid step motor. Some flux leakage occurs in normal operation.

M SERIES ENHANCED HYBRID SIGMAX® TECHNOLOGY

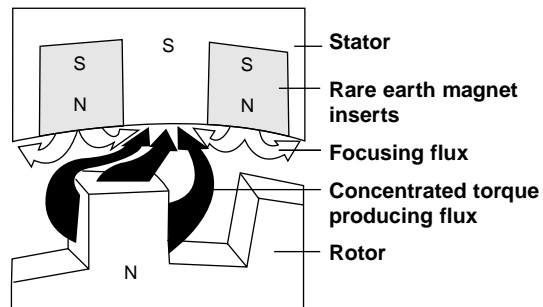

Patented Sigmax® technology* redirects magnetic flux to inhibit leakage and optimize torque production.

* Sigmax® technology is covered by U.S. patents 4,712,028, 4,713,470, 4,763,034 and 4,827,164.

TECHNICAL OVERVIEW

Types

POWERMAX II M Series	Hybrid step motors with rare earth magnets in the stator teeth
POWERMAX II P Series	Hybrid step motors

Rotor construction

POWERMAX II M and P Series; with "L" rotor designates	Laminated (high speed efficiency)
POWERMAX II M and P Series; with "J" rotor designates	Low mass/low inertia (fast start/stop, high acceleration)

Windings

A, B, C, D, E, F, G	Standard winding to match any application
---------------------	---

Phases

	2
--	---

Full steps per revolution

	200
--	-----

Full step angle

	1.8°
--	------

Angular accuracy

POWERMAX II M and M "J"	±1.5% of one step, no load, non-cumulative
POWERMAX II P and P "J"	±3% of one step, no load, non-cumulative

Operating temperature

	-20 to 40°C
--	-------------

Insulation

	NEMA Class B, 130°C
--	---------------------

Insulation resistance

	100 Megohms @500V dc and 25°C
--	-------------------------------

Shaft load ratings

Max. radial load (at center of std. shaft extension)	20 lb.
Max. axial load (on front shaft extension toward motor)	13 lb.

Bearing life

Since large bearings (30 mm) are used, life is typically about 4 times that of 22 mm or smaller bearings used on other NEMA Size 23 motors. POWERMAX II bearing fatigue life (L₁₀) exceeds 10,000 hours at any rotational speed up to 10,000 full steps/second if operated within the max. radial and axial loads specified above.

Encoder options

See page 53.

POWERMAX II® HYBRIDS

NEMA 23 FRAME (2.3")—Ratings and Characteristics

Review the Model Number Code on page 39 to assure that all options are designated. Dimensions, connections and phasing diagrams are on page 49. In addition to those below, motors with characteristics for specific performance requirements are offered. Contact factory for more details.

Motor Model Number	Connection [△]			Holding Torque [△]	Rated Current/Phase [△]	Phase Resistance (ohms) [△]	Phase Inductance [△]	Detent Torque [△]	Thermal Resistance [△]	Rotor Inertia [△]	Weight
	Parallel	Series	Unipolar	(2 phases on) oz-in (Nm) ±10%	(amps DC)	±10%	(mH) Typical	oz-in (Nm)	(°C/watt)	oz-in-S ² (kgm ² x 10 ⁻³)	lbs (kg)
Torque range: 42-61 oz-in. .29-.43 Nm				59 (0.42)	5.2	0.22	0.5				
P2HNXXH-LXX-XX-00	•			59 (0.42)	2.6	0.90	1.9				
P2HNXXH-LXX-XX-00		•		42 (0.29)	3.68	0.44	0.5				
STANDARD P2H Series 1/2 rotor stack				59 (0.42)	2.6	0.76	1.9				
P2HNXXB-LXX-XX-00	•			59 (0.42)	1.3	3.04	7.6				
P2HNXXB-LXX-XX-00		•		42 (0.29)	1.84	1.52	1.9				
P2HNXXC-LXX-XX-00	•			61 (0.43)	2.5	0.84	2.3				
P2HNXXC-LXX-XX-00		•		61 (0.43)	1.25	3.36	9.2				
P2HNXXC-LXX-XX-00			•	43 (0.30)	1.77	1.68	2.3				
P2HNXXF-LXX-XX-00	•			60 (0.42)	1.61	1.92	5.1				
P2HNXXF-LXX-XX-00		•		60 (0.42)	0.80	7.68	20.4				
P2HNXXF-LXX-XX-00			•	42 (0.30)	1.10	3.84	5.1				
								2.5 (0.018)	6.6	0.0010 (0.007)	1.0 (0.45)

All ratings typical and at 25°C unless otherwise noted.

- [△] An "X" in the Model Number Code indicates an undefined option. Colored letter indicates winding. See Model Number Code on page 39.
- [△] See Model Number Code on page 39, optional leaded connectors on page 52 and connection information on page 52.
- [△] With rated current applied. Windings at 130°C and motor unmounted and in still air at 40°C (without heat sink).

[△] Windings at 130°C and motor in still air at 40°C (without heat sink). Operation of these motors above rated current may cause demagnetization. Contact factory.

[△] Small signal inductance as measured with impedance bridge at 1kHz, 1 amp.

[△] Thermal resistance measured with motor hanging in still air (unmounted).

POWERMAX II® HYBRIDS

NEMA 23 FRAME (2.3")—Ratings and Characteristics (Con't)

Review the Model Number Code, page 39, to assure that all options are designated. Dimensions, connections and phasing diagrams are on page 49. In addition to those below, motors with characteristics for specific performance requirements are offered. Contact factory for more details.

Rated Currents are in descending order	Motor Model Number Δ	Connection Δ			Holding Torque Δ (2 phases on) oz-in (Nm) $\pm 10\%$	Rated Current/Phase Δ (amps DC)	Phase Resistance (ohms) $\pm 10\%$	Phase Inductance Δ (mH) Typical	Detent Torque oz-in (Nm)	Thermal Resistance Δ (°C/watt)	Rotor Inertia oz-in-S ² (kgm ² x 10 ⁻³)	Weight lbs (kg)
		Parallel	Series	Unipolar								
Torque range: 95-144 oz-in. .67-1.02 Nm	M21NXXA-LXX-XX-00	•			142 (1.00)	5.6	0.23	0.7	↑	↑	↑	↑
	M21NXXA-LXX-XX-00		•		142 (1.00)	2.8	0.92	2.8				
	M21NXXA-LXX-XX-00			•	100 (0.71)	4.0	0.46	0.7				
SIGMAX® M21 Series 1 rotor stack	M21NXXB-LXX-XX-00	•			137 (0.97)	4.6	0.32	1.0	9.4 (0.066)	5.5	0.0017 (0.012)	1.5 (0.68)
	M21NXXB-LXX-XX-00		•		137 (0.97)	2.3	1.28	4.0				
	M21NXXB-LXX-XX-00			•	97 (0.68)	3.3	0.64	1.0				
	M21NXXC-LXX-XX-00	•			144 (1.02)	3.5	0.53	2.0				
	M21NXXC-LXX-XX-00		•		144 (1.02)	1.75	2.12	8.0				
	M21NXXC-LXX-XX-00			•	102 (0.72)	2.5	1.06	2.0				
	M21NXXD-LXX-XX-00	•			135 (0.95)	1.51	2.61	8.7	↓	↓	↓	↓
	M21NXXD-LXX-XX-00		•		135 (0.95)	0.76	10.4	34.8				
	M21NXXD-LXX-XX-00			•	95 (0.67)	1.07	5.22	8.7				
Torque range: 77-116 oz-in. .54-.82 Nm	P21NXXA-LXX-XX-00	•			114 (0.81)	5.6	0.23	0.8	↑	↑	↑	↑
	P21NXXA-LXX-XX-00		•		114 (0.81)	2.8	0.92	3.2				
	P21NXXA-LXX-XX-00			•	81 (0.57)	4.0	0.46	0.8				
STANDARD P21 Series 1 rotor stack	P21NXXB-LXX-XX-00	•			111 (0.79)	4.6	0.32	1.1	4 (0.028)	5.5	0.0017 (0.012)	1.5 (0.68)
	P21NXXB-LXX-XX-00		•		111 (0.79)	2.3	1.28	4.4				
	P21NXXB-LXX-XX-00			•	79 (0.55)	3.3	0.64	1.1				
	P21NXXC-LXX-XX-00	•			116 (0.82)	3.5	0.53	2.3				
	P21NXXC-LXX-XX-00		•		116 (0.82)	1.75	2.12	9.2				
	P21NXXC-LXX-XX-00			•	82 (0.58)	2.5	1.06	2.3				
	P21NXXD-LXX-XX-00	•			109 (0.77)	1.51	2.61	10.3	↓	↓	↓	↓
	P21NXXD-LXX-XX-00		•		109 (0.77)	0.76	10.4	41.2				
	P21NXXD-LXX-XX-00			•	77 (0.54)	1.07	5.22	10.3				

All ratings typical and at 25°C unless otherwise noted.

Δ An "X" in the Model Number Code indicates an undefined option. Colored letter indicates winding. See Model Number Code on page 39.

Δ See Model Number Code on page 39, optional leaded connectors on page 52 and connection information on page 52.

Δ With rated current applied. Windings at 130°C and motor unmounted and in still air at 40°C (without heat sink).

Δ Windings at 130°C and motor in still air at 40°C (without heat sink). Operation of these motors above rated current may cause demagnetization. Contact factory.

Δ Small signal inductance as measured with impedance bridge at 1kHz, 1 amp.

Δ Thermal resistance measured with motor hanging in still air (unmounted).

POWERMAX II® HYBRIDS

NEMA 23 FRAME (2.3")—Ratings and Characteristics (Con't.)

Review the Model Number Code, page 39, to assure that all options are designated. Dimensions, connections and phasing diagrams are on page 49. In addition to those below, motors with characteristics for specific performance requirements are offered. Contact factory for more details.

Motor Model Number [△]	Connection [△]			Holding Torque [△]	Rated Current/Phase [△]	Phase Resistance (ohms) [△]	Phase Inductance [△]	Detent Torque oz-in (Nm)	Thermal Resistance [△] (°C/watt)	Rotor Inertia oz-in-S ² (kgm ² x 10 ⁻³)	Weight lbs (kg)
	Parallel	Series	Unipolar	(2 phases on) oz-in (Nm) ±10%	(amps DC)	±10%	(mH) Typical				
Torque range: 161-253 oz-in. 1.13-1.79 Nm	M22NXXA-LXX-XX-00	•		230 (1.62)	6.5	0.21	0.7	↑ 17 (0.12) ↓	↑ 4.5 ↓	↑ 0.0036 (0.025) ↓	↑ 2.5 (1.13) ↓
	M22NXXA-LXX-XX-00		•	230 (1.62)	3.3	0.84	2.8				
	M22NXXA-LXX-XX-00			163 (1.15)	4.6	0.42	0.7				
SIGMAX® M22 Series 2 rotor stack	M22NXXB-LXX-XX-00	•		253 (1.79)	4.6	0.38	1.7				
	M22NXXB-LXX-XX-00		•	253 (1.79)	2.3	1.52	6.8				
	M22NXXB-LXX-XX-00			179 (1.26)	3.3	0.76	1.7				
M22NXXC-LXX-XX-00	•		238 (1.68)	3.1	0.78	3.1					
M22NXXC-LXX-XX-00		•	238 (1.68)	1.55	3.12	12.4					
M22NXXC-LXX-XX-00			168 (1.19)	2.2	1.56	3.1					
M22NXXD-LXX-XX-00	•		238 (1.68)	2.5	1.22	5.0					
M22NXXD-LXX-XX-00		•	238 (1.68)	1.25	4.88	20.0					
M22NXXD-LXX-XX-00			168 (1.19)	1.77	2.44	5.0					
M22NXXE-LXX-XX-00	•		227 (1.60)	1.64	2.71	10.1					
M22NXXE-LXX-XX-00		•	227 (1.60)	0.82	10.8	40.4					
M22NXXE-LXX-XX-00			161 (1.13)	1.16	5.42	10.1					
Torque range: 138-214 oz-in. .97-1.51 Nm	P22NXXA-LXX-XX-00	•		197 (1.39)	6.5	0.21	0.8	↑ 7 (0.049) ↓	↑ 4.5 ↓	↑ 0.0036 (0.025) ↓	↑ 2.5 (1.13) ↓
	P22NXXA-LXX-XX-00		•	197 (1.39)	3.3	0.84	3.2				
	P22NXXA-LXX-XX-00			139 (0.98)	4.6	0.42	0.8				
STANDARD P22 Series 2 rotor stack	P22NXXB-LXX-XX-00	•		214 (1.51)	4.6	0.38	2.1				
	P22NXXB-LXX-XX-00		•	214 (1.51)	2.3	1.52	8.4				
	P22NXXB-LXX-XX-00			151 (1.07)	3.3	0.76	2.1				
P22NXXC-LXX-XX-00	•		203 (1.43)	3.1	0.78	3.9					
P22NXXC-LXX-XX-00		•	203 (1.43)	1.55	3.12	15.6					
P22NXXC-LXX-XX-00			144 (1.01)	2.2	1.56	3.9					
P22NXXD-LXX-XX-00	•		203 (1.43)	2.5	1.22	6.2					
P22NXXD-LXX-XX-00		•	203 (1.43)	1.25	4.88	24.8					
P22NXXD-LXX-XX-00			144 (1.01)	1.77	2.44	6.2					
P22NXXE-LXX-XX-00	•		195 (1.38)	1.64	2.7	12.6					
P22NXXE-LXX-XX-00		•	195 (1.38)	0.82	10.8	50.4					
P22NXXE-LXX-XX-00			138 (0.97)	1.16	5.4	12.6					

All ratings typical and at 25°C unless otherwise noted.

△ An "X" in the Model Number Code indicates an undefined option. Colored letter indicates winding. See Model Number Code on page 39.

△ See Model Number Code on page 39 optional leaded connectors on page 52 and connection information on page 52.

△ With rated current applied. Windings at 130°C and motor unmounted and in still air at 40°C (without heat sink).

△ Windings at 130°C and motor in still air at 40°C (without heat sink). Operation of these motors above rated current may cause demagnetization. Contact factory.

△ Small signal inductance as measured with impedance bridge at 1kHz, 1 amp.

△ Thermal resistance measured with motor hanging in still air (unmounted).

POWERMAX II®

HYBRIDS WITH LOW INERTIA ROTORS

ROTOR INERTIA CHARACTERISTICS . . . POWERMAX II® motors

Single and double stack POWERMAX II® motors are available with both standard and low inertia rotors. Choose low inertia to produce the highest acceleration rates possible.

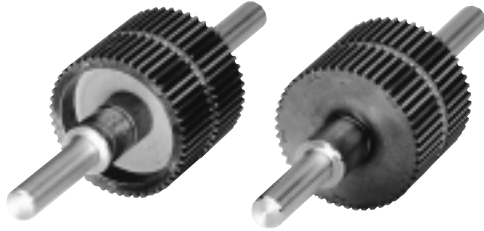

Low inertia rotor

Standard rotor

ACCELERATION COMPARISON

	Model	Rotor Type	△ Inertia oz-in-S ² x 10 ⁻³ / kgm ² x 10 ⁻³	Theoretical Normalized △ Acceleration comparison
Single Stack	P21NRXX-L	Standard	1.68/0.010	1
	P21NRXX-J	Low inertia	1.30/0.008	1.27
	M21NRXX-L	Standard	1.68/0.010	1.23
	M21NRXX-J	Low inertia	1.30/0.008	1.59
Double Stack	P22NRXX-L	Standard	3.57/0.022	1
	P22NRXX-J	Low inertia	2.59/0.016	1.30
	M22NRXX-L	Standard	3.57/0.022	1.18
	M22NRXX-J	Low inertia	2.59/0.016	1.63

△ Low inertia rotors not offered for half stack models

△ Comparative values for normalized acceleration of unloaded motors. Base value is standard hybrid motor with standard rotor, indicated for single and double stack lengths.

Actual acceleration capability depends on load, velocity profile and driver power. Comparisons made with 90°C temperature rise using bipolar driver.

NEMA 23 FRAME (2.3")—Ratings and Characteristics

Review the Model Number Code, page 39, to assure that all options are designated. Dimensions, connections and phasing diagrams start on page 49. In addition to those below, all 1 and 2 stack "L" construction windings, page 59, and custom windings for specific performance requirements are available with low inertia rotors. Contact factory for more details.

Motor Model Number △	Connection △			Holding Torque △ (2 phases on) oz-in (Nm) ±10%	Rated Current/ Phase △ (amps DC)	Phase Resistance (ohms) ±10%	Phase Inductance △ (mH) Typical	Detent Torque oz-in (Nm)	Thermal Resistance △ (°C/watt)	Rotor Inertia oz-in-S ² (kgm ² x 10 ⁻³)	Weight lbs (kg)
	Parallel	Series	Unipolar								
Torque range: 99-140 oz-in. .70-.99 Nm											
M21NXXA-JXX-XX-00	•			140 (0.99)	5.6	0.23	0.7				
M21NXXA-JXX-XX-00		•		140 (0.99)	2.8	0.92	2.8	9.4			
M21NXXA-JXX-XX-00			•	99 (0.70)	4.0	0.46	0.7	(0.066)			
SIGMAX® M21 Series 1 rotor stack											
Torque range: 79-111 oz-in. .55-.78 Nm											
P21NXXA-JXX-XX-00	•			111 (0.78)	5.6	0.23	0.9				
P21NXXA-JXX-XX-00		•		111 (0.78)	2.8	0.92	3.6	4			
P21NXXA-JXX-XX-00			•	79 (0.55)	4.0	0.46	0.9	(0.028)			
STANDARD P21Series 1 rotor stack											
Torque range: 178-252 oz-in. 1.26-1.78 Nm											
M22NXXB-JXX-XX-00	•			252 (1.78)	4.6	0.38	1.5				
M22NXXB-JXX-XX-00		•		252 (1.78)	2.3	1.52	6.0	17			
M22NXXB-JXX-XX-00			•	178 (1.26)	3.3	0.76	1.5	(0.12)			
SIGMAX® M22 Series 2 rotor stack											
Torque range: 142-201 oz-in. 1.00-1.42 Nm											
P22NXXB-JXX-XX-00	•			201 (1.42)	4.6	0.38	1.8				
P22NXXB-JXX-XX-00		•		201 (1.42)	2.3	1.52	7.2	7			
P22NXXB-JXX-XX-00			•	142 (1.00)	3.3	0.76	1.8	(0.049)			
STANDARD P22 Series 2 rotor stack											

All ratings typical and at 25°C unless otherwise noted.

△ An "X" in the Model Number Code indicates an undefined option. Colored letter indicates winding. See Model Number Code on page 39.

△ See Model Number Code on page 39, optional leaded connectors on page 52 and connection information on page 52.

△ With rated current applied. Windings at 130°C and motor unmounted and in still air at 40°C (without heat sink).

△ Windings at 130°C and motor in still air at 40°C (without heat sink). Operation of these motors above rated current may cause demagnetization. Contact factory

△ Small signal inductance as measured with impedance bridge at 1kHz, 1 amp.

△ Thermal resistance measured with motor hanging in still air (unmounted).

DIMENSIONS... (POWERMAX II® HYBRIDS) $\frac{\text{in.}}{\text{mm}}$ (metric dim. for ref. only)

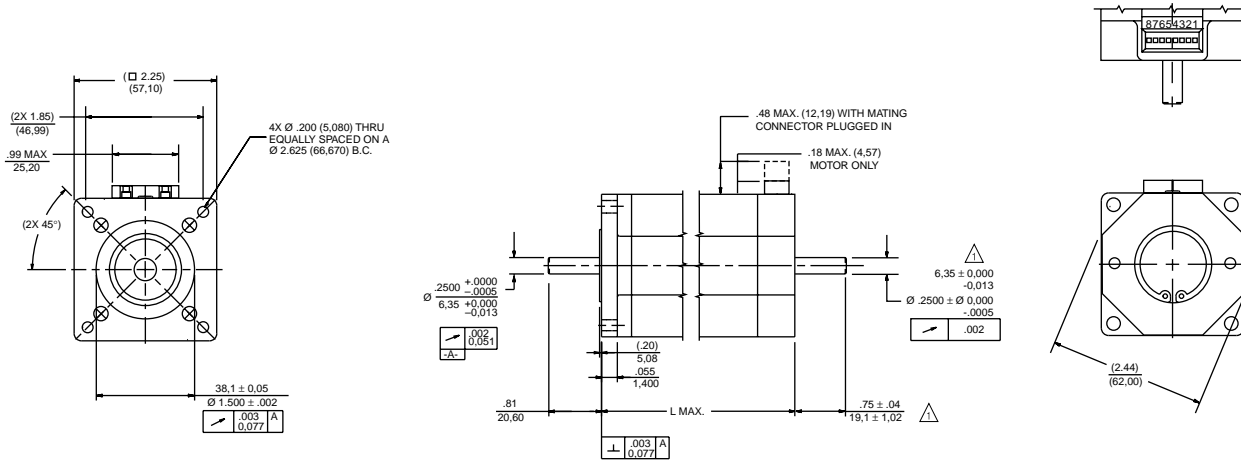

Motor Model	L Max.
P2H	1.60 40,7
P or M21	2.06 52,3
P or M22	3.10 78,7

STANDARD SHAFT OPTIONS

1. Shaft modifications also available. See page 39.
2. Optional flat available on front shaft as shown.

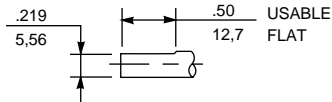

△ Optional rear shaft extension available as shown. Same diameter as front shaft extension.

ENCODER OPTION

See page 53 for encoder/mounting specifications.

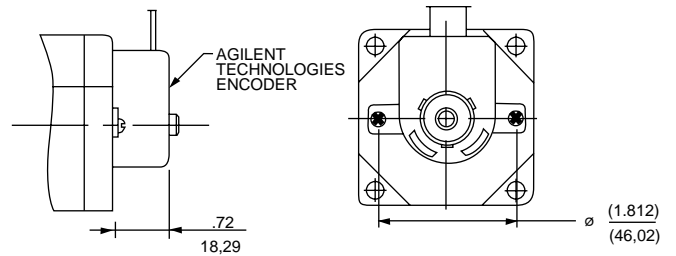

CONNECTION INFORMATION... Terminations and phase sequencing

NOTE: Phase sequencing direction of rotation as viewed from mounting end of motor.

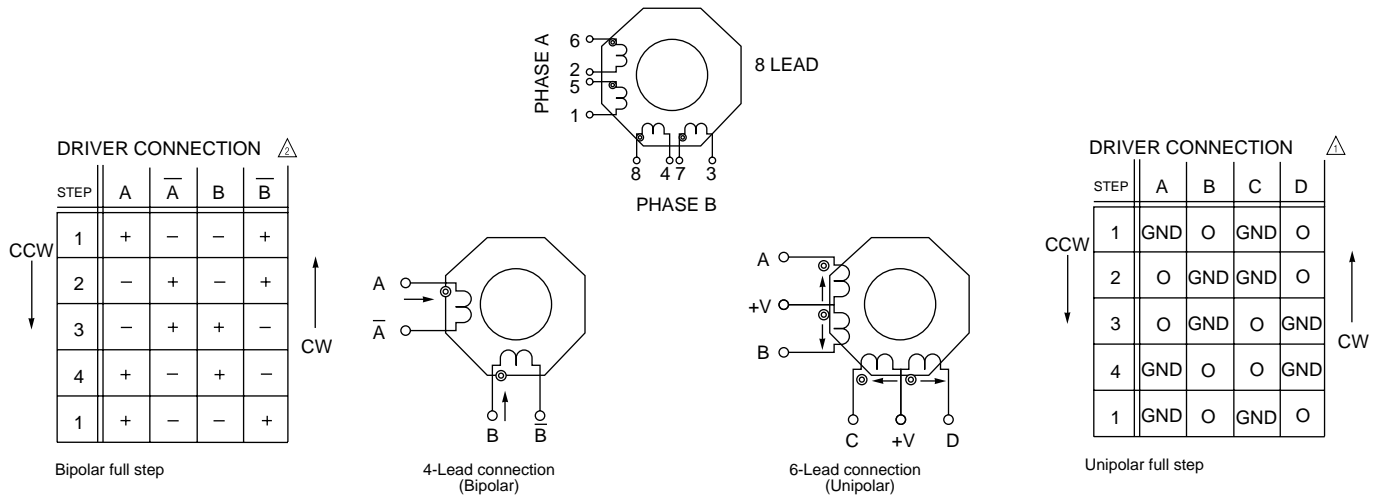

△ Notes:

- 0 = off or open
- + = positive current flow
- = negative current flow
- GND = ground

POWERMAX II® Flying Lead Motor Connection Informations

CONNECTION	LEAD COLOR	DRIVER CONNECTION
4-LEAD BIPOLAR	BLK	A
BIPOLAR	ORG	\bar{A}
SERIES	RED	B
	YEL	\bar{B}
	WHT/BLK & WHT/ORG	—
	WHT/RED & WHT/YE	—
	WHT/RED & WHT/YEL	—
4-LEAD BIPOLAR	BLK & WHT/ORG	\bar{A}
BIPOLAR	ORG & WHT/BLK	A
PARALLEL	RED & WHT/YEL	\bar{B}
	YEL & WHT/RED	B
6-LEAD UNIPOLAR	BLK	A
UNIPOLAR	ORG	B
	RED	C
	YEL	D
	WHT/BLK & WHT/ORG	+V
	WHT/RED & WHT/YEL	+V

CONNECTION INFORMATION . . . Terminations and phase sequencing

NOTE: Phase sequencing direction of rotation as viewed from mounting end of motor.

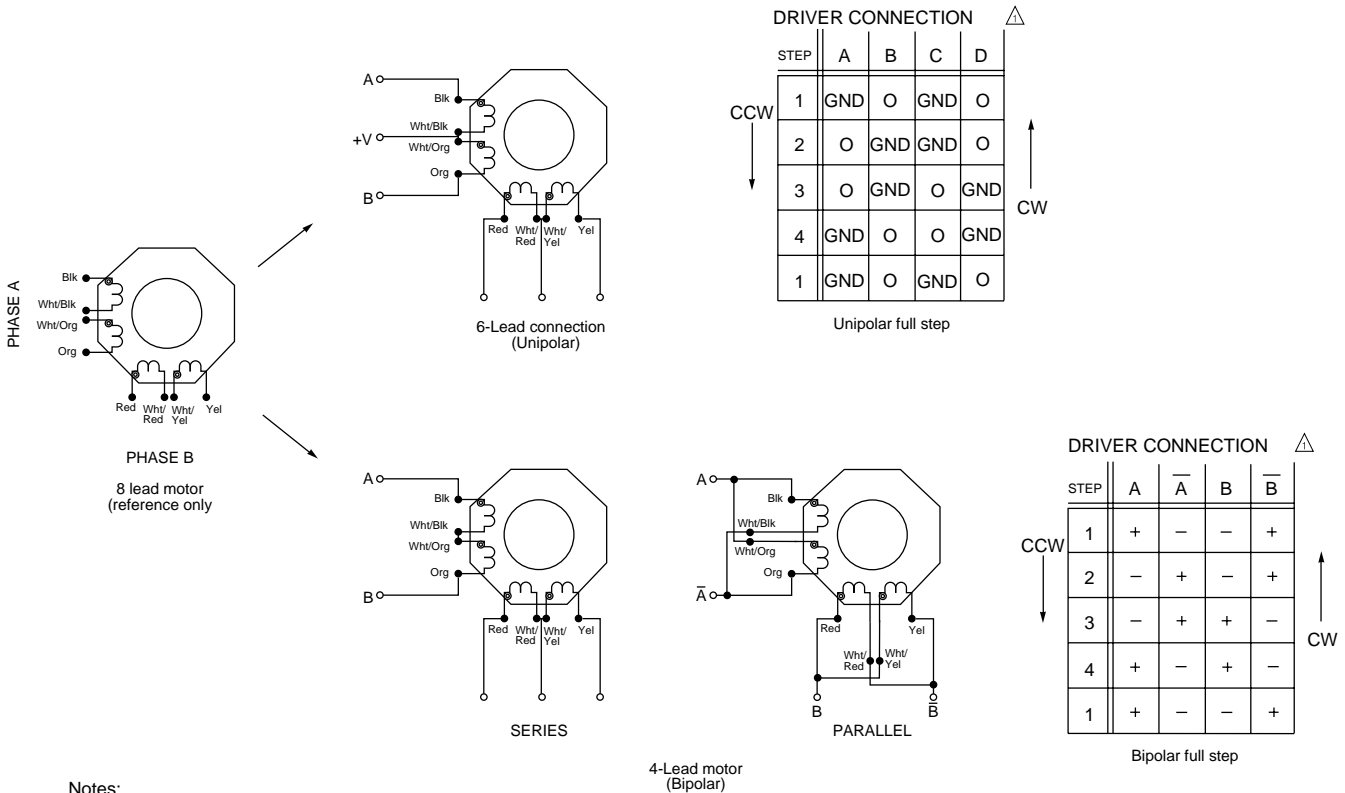

Notes:

- △ 0 = off or open
- + = positive current flow
- = negative current flow
- GND = ground

POWERMAX II® Flying Lead Motor

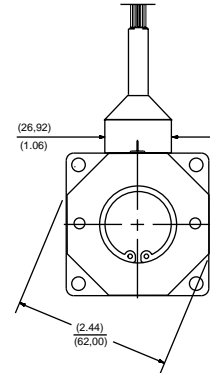
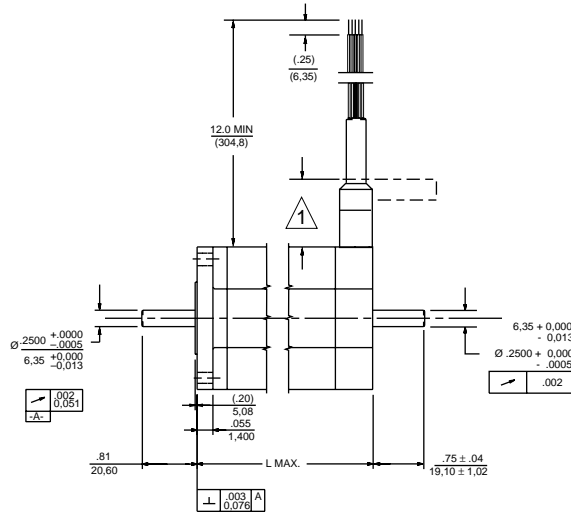
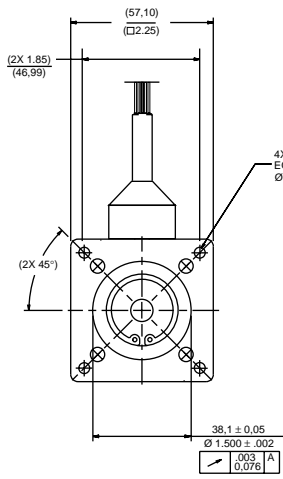

Motor Model	L Max.
P2H	1.60 40,7
P or M21	2.06 52,4
P or M22	3.10 78,8

NOTES:

- △ Flexible rubber boot may be bent as shown. Normal height 1.0 inch (25,4)

POWERMAX II® CONNECTION INFORMATION . . .

. . . Optional leaded connectors

Four different leaded connectors are available from Pacific Scientific. Order the "GW" part number as a separate item.

Part Number	Phase Connection	Pin No.	Connector/Leadwire Assembly Lead Colors	Driver Connection
GW0000F (8 Lead)	bipolar series	6	Black	A
		1	Orange	\bar{A}
		8	Red	B
		3	Yellow	\bar{B}
		2 & 5	Wht/Blk & Wht/Org	none
		4 & 7	Wht/Red & Wht/Yel	none
	bipolar parallel	6 & 5	Blk & Wht/Org	A
		1 & 2	Org & Wht/Blk	\bar{A}
		8 & 7	Red & Wht/Yel	B
		3 & 4	Yel & Wht/Red	\bar{B}
	unipolar	6	Black	A
		1	Orange	B
		8	Red	C
		3	Yellow	D
		2 & 5	Wht/Blk & Wht/Org	+ V
		4 & 7	Wht/Red & Wht/Yel	+ V
GW0000E (6 Lead)	unipolar	6	Black	A
		1	Orange	B
		8	Red	C
		3	Yellow	D
		2 & 5	Wht/Blk & Org	+ V
		4 & 7	Wht/Red & Yel	+ V
GW0000H (4 Lead)	bipolar parallel	6 & 5	Black	A
		1 & 2	Orange	\bar{A}
		8 & 7	Red	B
		3 & 4	Yellow	\bar{B}
GW0000L (4 Lead)	bipolar series	6	Black	A
		1	Orange	\bar{A}
		8	Red	B
		3	Yellow	\bar{B}

Typical leaded connector (4-lead shown)

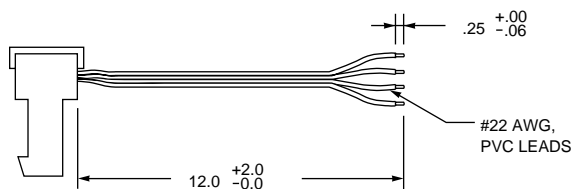

. . . Optional mating connector only

A separate mating connector housing and strain relief cover are available from Pacific Scientific or AMP. The user attaches leads to the connector.

ITEM	PACIFIC SCIENTIFIC	AMP
STANDARD HOUSING	GP00012	641653-8
STANDARD COVER	GP00013	643077-8

Optional Ground Wire

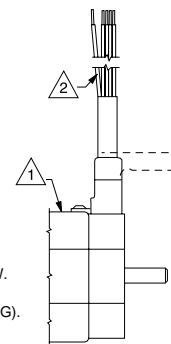

NOTES:

- △ GROUND LABEL PLACED IN FRONT OF GROUND SCREW.
- △ GREEN/YELLOW SAFETY EARTH CONDUCTOR (18AWG).

See page 39 for ordering information.

ENCODER OPTIONS

NEMA 23 ENCODER OPTION

The standard encoder offered on the NEMA 23 motor is the Agilent Technologies HEDS 5600 series.

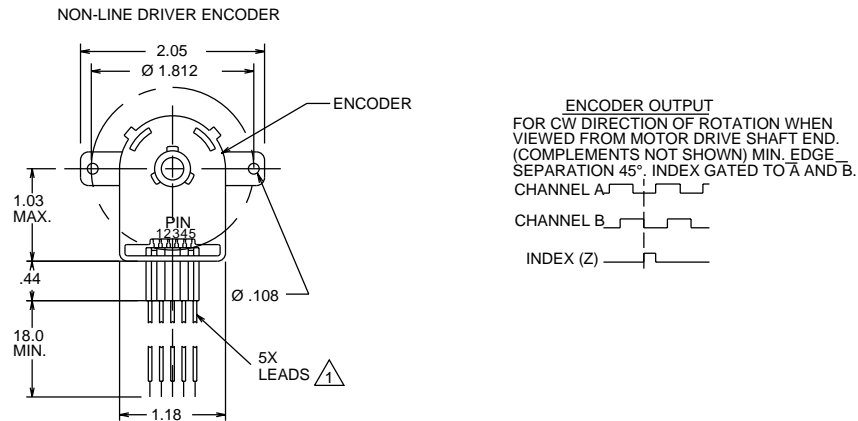

PIN	COLOR	FUNCTION
1	BLACK	GROUND
2	BLUE	Z
3	WHITE	A
4	RED	+5V
5	BROWN	B

PARAMETERS \triangle	NON-LINE DRIVER	
	INCREMENTAL	
ENCODER OPTION	HD	HJ
PULSES PER REVOLUTION	500	512
SUPPLY VOLTAGE	+5V \pm 10% @ 85 mA MAX.	
OUTPUT FORMAT	DUAL CHANNEL QUADRATURE AND INDEX	
OUTPUT TYPE	SQUARE WAVE TTL COMPATIBLE	
FREQUENCY RESPONSE:		
DATA	100 kHz	
INDEX	100 kHz	
ROTOR INERTIA	5×10^{-7} lb-in-S ²	
WEIGHT	0.08 lb.	

ENCODER MOUNTING PROVISION ONLY = M1

FOR AGILENT TECHNOLOGIES HEDS 5600 SERIES OR SIMILAR.

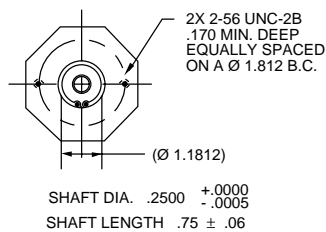

NOTES:

- \triangle Leads are terminated with Agilent Technologies HEDS-8903 connector.
- \triangle TYPICAL @ 25° C

CONVENTIONAL HYBRIDS

NEMA 23, 34 and 42 Frames



The H and E Series are both high efficiency, low loss hybrid step motors in conventional (round frame) configurations.

For increased torque and acceleration, E Series general purpose motors feature our patented Sigmax[®] technology.

Both H and E Series motors provide the high speed capability required for rapid traverse applications.

AGENCY APPROVAL

All NEMA 34 and 42 frame motors are UL 1004 recognized (E61960); Class B motor insulation (File E103510).

STANDARD OPTIONS

Our general purpose hybrid steppers allow you to tailor a motor to your in-plant or OEM application.

Select from terminal board connections (via conduit), MS connectors or flying lead connections in waterproof or standard enclosures. Options include shaft keyways or flats, oversized drive shaft, rear shaft extensions and various encoder options. Bipolar or unipolar phase sequencing is also available.

WIDE RANGE OF WINDINGS

General purpose step motors are available with a wide range of windings.

Use our A through E windings to duplicate or improve upon existing motor performance. They will directly replace a large number of OEM catalog step motors.

T and P windings are offered to optimize performance. T windings generate maximum low end torque, while P windings deliver an edge in torque at higher speeds.

FEATURES

Torque Production Over Wide Speed Range

Extensive Selection of Shaft, End Bell, Termination, Encoder, and Splashproof Options

UL Recognized Models

Wide Range of Industry and Standard Winding Configurations

Sigmax[®] Technology

NEMA 23, 34, and 42 Frames

Two Year Warranty

BENEFITS

High quality, long life motor

An array of options to meet your needs

Safety and acceptability

Match motor performance to your application

Flux focusing increases torque

Broad selection to meet your application specific requirements

High quality, dependable operation

CONVENTIONAL HYBRID SELECTION OVERVIEW

General Purpose Conventional Hybrids		NEMA 23		NEMA 34		NEMA 42	
		(2.3" square frame)		(3.4" square frame)		(4.2" square frame)	
		Holding torque range		Holding torque range		Holding torque range	
		oz-in. (Nm)	Page	oz-in. (Nm)	Page	oz-in. (Nm)	Page
E Series-Sigma[®] technology	1 stack	85-126 (0.60-0.89)	58	223-349 (1.58-1.90)	62	957-1378 (6.76-9.73)	69
	2 stacks	148-225 (1.05-1.59)	59	443-676 (3.13-4.75)	63	1805-2698 (12.75-19.06)	70
	3 stacks			656-995 (4.63-5.40)	63	2667-3958 (18.84-27.95)	71
	4 stacks			879-1300 (6.21-9.18)	64		
H-Series-standard hybrid	1/2 stack	36-51 (0.25-0.36)	58				
	1 stack	59-87 (0.41-0.61)	58	158-186 (1.21-1.71)	62	585-839 (4.13-5.93)	69
	2 stacks	103-156 (0.73-1.10)	59	314-471 (2.22-3.32)	63	1118-1652 (7.90-11.66)	70
	3 stacks			466-698 (3.29-4.93)	64	1529-2651 (10.80-18.72)	71
	4 stacks			624-916 (4.41-6.47)	64		
Special Purpose Conventional Hybrids							
E "J" Series- Sigma[®] technology- low inertia rotor	1 stack	77-108 (0.54-0.77)	75				
	2 stacks	139-196 (0.98-1.39)	75				
H "J" Series- standard hybrid-low inertia rotor	1 stack	54-77 (0.38-0.54)	75				
	2 stacks	99-141 (0.70-0.99)	75				

CONVENTIONAL HYBRID STEP MOTORS INDEX

How to use this section

This section of the catalog deals with our extensive line of high performance hybrid step motors. If you need application assistance, please refer to pages 6 - 9. Our Selection Overview on page 30 will also prove helpful in finding the right step motor family for your application.

Or use the index at right to quickly locate information on the NEMA 23, 34, or 42 frame hybrid step motor that is best suited to your application.

General Purpose NEMA 23 Frame

Model Number Code	Page 55
Ratings & Characteristics	Page 58-59
Mounting Dimensions	Page 60
Connection Information	Page 76-78
Encoder Options	Page 79

General Purpose NEMA 34 Frame

Model Number Code	Page 61
Ratings & Characteristics	Page 62-64
Mounting Dimensions	Page 65-67
Connection Information	Page 76-78
Encoder Options	Page 80

General Purpose NEMA 42 Frame

Model Number Code	Page 68
Ratings & Characteristics	Page 69-71
Mounting Dimensions	Page 72
Connection Information	Page 76-78
Encoder Options	Page 80

Special Purpose - NEMA 23 Frame

Model Number Code	Page 73
Ratings & Characteristics	Page 75

Technical Data

Page 76-81

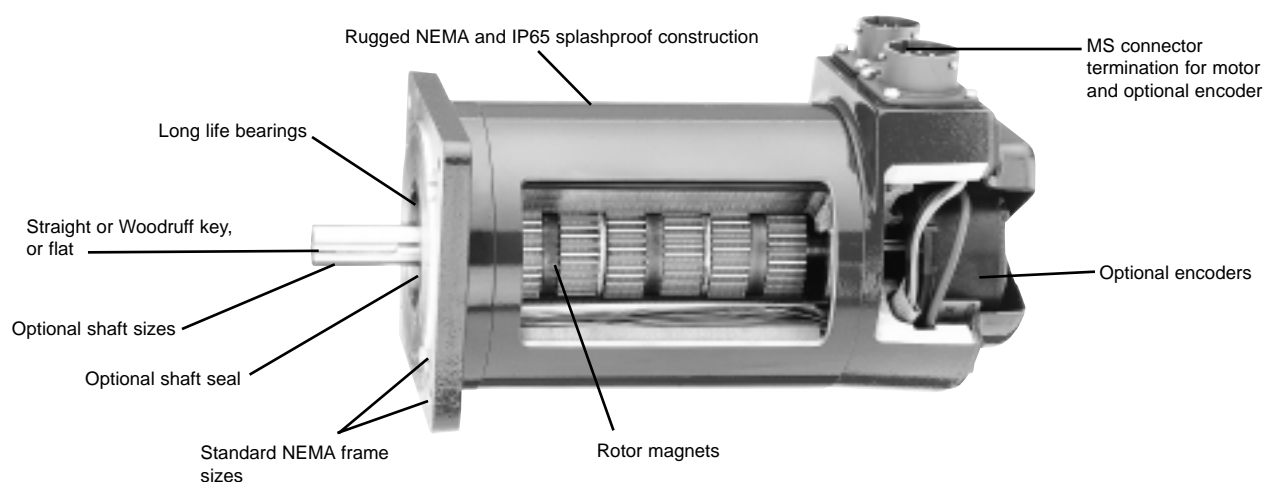

Sigma[®] technology adds flux concentrating rare earth stator magnets for highest torque and acceleration

GENERAL PURPOSE— CONVENTIONAL HYBRIDS NEMA 23 FRAME (2.3" Dia.)

GENERAL PURPOSE—CONVENTIONAL HYBRIDS NEMA 23 FRAME (2.3" Dia.)

MODEL NUMBER CODE

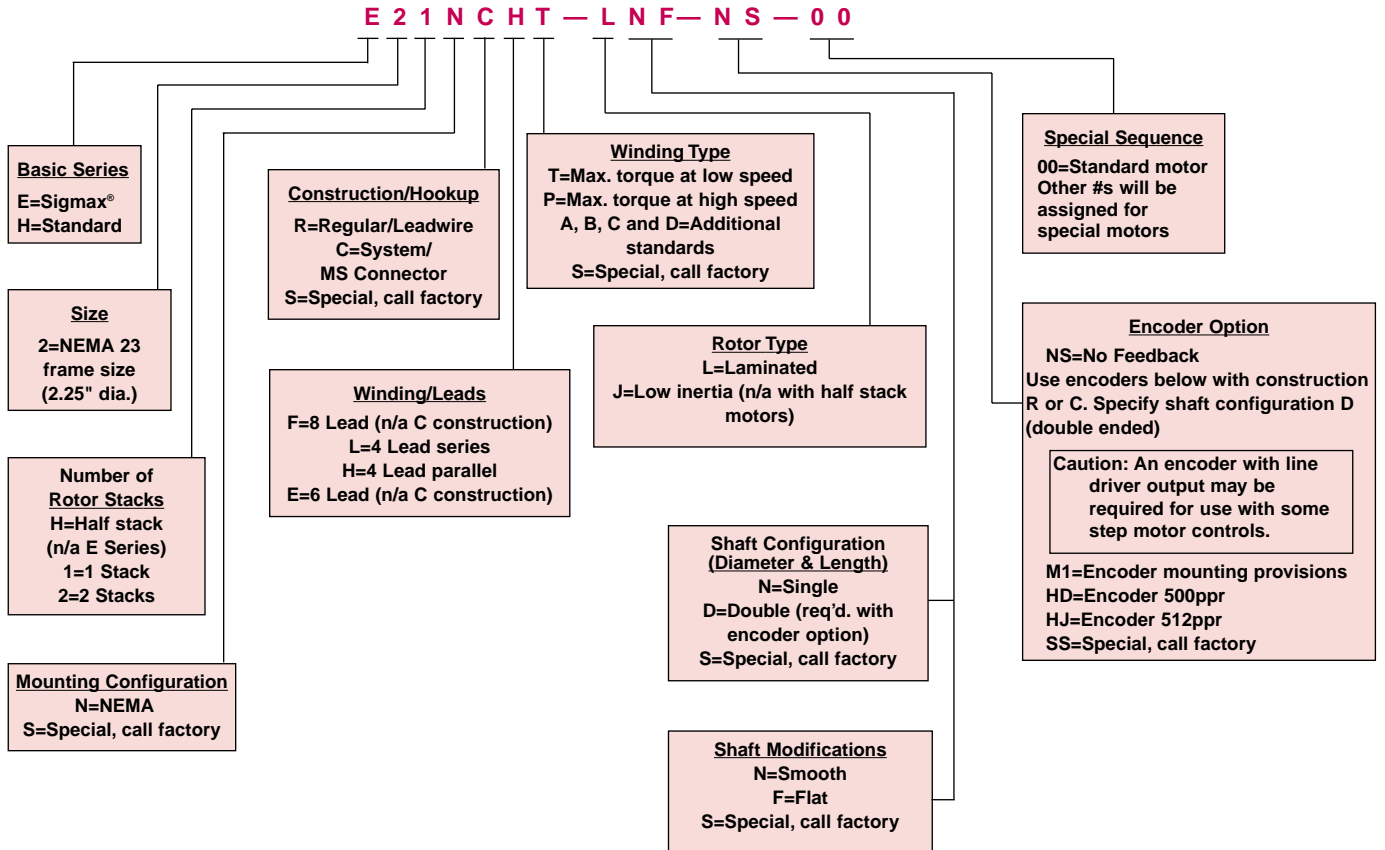

The example model number above indicates an E series (Sigmax®) NEMA 23 frame motor with a one stack rotor. This motor is equipped with an MS connector on the end of a 12 inch cable for power, a bipolar parallel connection, a maximum torque at low speed winding and a single ended shaft with a flat.

HOW TO ORDER

Review the Motor Model Number code to assure that all options are designated. Connections, encoders and phasing diagrams start on page 76. Motor dimensions are on page 60.

GENERAL PURPOSE—CONVENTIONAL HYBRIDS

NEMA 23 FRAME (2.3" Dia.)—Ratings and Characteristics

Review the Model Number Code, page 55, to assure that all options are designated. Connections, encoders and phasing diagrams start on page 76. Motor dimensions are on page 60. In addition to those below, motors with characteristics for specific performance requirements are offered. Contact factory for more details.

Rated currents are in descending order	Motor Model Number Δ	Connection Δ			Holding Torque Δ (2 phases on) oz-in (Nm) $\pm 10\%$	Rated Current/Phase Δ (amps DC)	Phase Resistance (ohms) $\pm 10\%$	Phase Inductance Δ (mH) Typical	Detent Torque oz-in (Nm)	Thermal Resistance Δ (°C/watt)	Rotor Inertia oz-in-S ² (kgm ² x 10 ⁻³)	Weight lbs (kg)		
		Parallel	Series	Unipolar										
Torque range: 36-51 oz-in. .25-.36 Nm	H2HNXHA-LXX-XX-00	•			51 (0.36)	4.9	0.22	0.5	↑	↑	↑	↑		
	H2HNXLA-LXX-XX-00	•			51 (0.36)	2.4	0.79	2.0						
	H2HNXEA-LXX-XX-00		•		36 (0.26)	3.5	0.41	0.5						
	STANDARD H2H Series 1/2 rotor stack	H2HNXHT-LXX-XX-00	•			50 (0.36)	2.5	0.75	1.8	↑	7.1	0.0010 (0.007)	0.9 (0.41)	
		H2HNXLT-LXX-XX-00	•			50 (0.36)	1.26	2.89	7.3					
		H2HNXET-LXX-XX-00		•		36 (0.25)	1.78	1.46	1.8					
		H2HNXHB-LXX-XX-00	•			51 (0.36)	2.4	0.79	2.0	↓	↓	↓	↓	
		H2HNXLB-LXX-XX-00	•			51 (0.36)	1.22	3.05	8.1					
		H2HNXEB-LXX-XX-00		•		36 (0.26)	1.73	1.54	2.0					
Torque range: 85-126 oz-in. .60-.89 Nm		E21NXHC-LXX-XX-00	•			120 (0.85)	5.8	0.19	0.5	↑	↑	↑	↑	
		E21NXLC-LXX-XX-00	•			120 (0.85)	2.9	0.67	1.9					
		E21NXEC-LXX-XX-00		•		85 (0.60)	4.1	0.35	0.5					
	SIGMAX® E21 Series 1 rotor stack	E21NXHA-LXX-XX-00	•			126 (0.89)	5.4	0.20	0.6	↑	6.0	0.0015 (0.011)	1.2 (0.55)	
		E21NXLA-LXX-XX-00	•			126 (0.89)	2.7	0.76	2.5					
		E21NXEA-LXX-XX-00		•		89 (0.63)	3.8	0.40	0.6					
		E21NXHT-LXX-XX-00	•			123 (0.87)	2.8	0.72	2.2	↓	↓	↓	↓	
		E21NXLT-LXX-XX-00	•			123 (0.87)	1.39	2.8	8.7					
		E21NXET-LXX-XX-00		•		87 (0.61)	1.97	1.42	2.2					
		E21NXHB-LXX-XX-00	•			123 (0.87)	1.41	2.73	8.5	↓	↓	↓	↓	
		E21NXLB-LXX-XX-00	•			123 (0.87)	0.71	10.8	33.9					
		E21NXEB-LXX-XX-00		•		87 (0.61)	1.0	5.42	8.5					
		Torque range: 59-87 oz-in. .41-.61 Nm	H21NXHC-LXX-XX-00	•			83 (0.58)	5.8	0.19	0.6	↑	↑	↑	↑
			H21NXLC-LXX-XX-00	•			83 (0.58)	2.9	0.67	2.2				
			H21NXEC-LXX-XX-00		•		59 (0.41)	4.1	0.35	0.6				
STANDARD H21 Series 1 rotor stack			H21NXHA-LXX-XX-00	•			87 (0.61)	5.4	0.21	0.7	↑	6.0	0.0015 (0.011)	1.2 (0.55)
			H21NXLA-LXX-XX-00	•			87 (0.61)	2.7	0.76	2.9				
			H21NXEA-LXX-XX-00		•		61 (0.43)	3.8	0.40	0.7				
	H21NXHT-LXX-XX-00		•			85 (0.60)	2.8	0.72	2.5	↓	↓	↓	↓	
	H21NXLT-LXX-XX-00		•			85 (0.60)	1.39	2.8	10.2					
	H21NXET-LXX-XX-00			•		60 (0.42)	1.97	1.42	1.42					
	H21NXHB-LXX-XX-00		•			84 (0.60)	1.41	2.73	9.9	↓	↓	↓	↓	
	H21NXLB-LXX-XX-00		•			84 (0.60)	0.71	10.8	39.5					
	H21NXEB-LXX-XX-00			•		60 (0.42)	1.0	5.42	9.9					

- All ratings typical and at 25°C unless otherwise noted.
- Δ An "X" in the Model Number Code indicates an undefined option. Colored letter indicates winding. See How to Order and Model Number Code on page 55.
- Δ Motor connections are determined by the Windings/Leads designation in the Model Number Code on page 55. Note that the F designation, although not shown in the above tables, is an 8-lead option...see Terminations, page 76. In addition to the lead wire termination, terminal board and MS connector hookup for parallel, series or unipolar operation is also available.

- Δ With rated current applied. Windings at 130°C and motor unmounted and in still air at 40°C (without heat sink).
- Δ Windings at 130°C and motor in still air at 40°C (without heat sink). Operation of these motors above rated current may cause demagnetization. Contact factory.
- Δ Small signal inductance as measured with impedance bridge at 1kHz, 1 amp.
- Δ Thermal resistance measured with motor hanging in still air (unmounted).

GENERAL PURPOSE—CONVENTIONAL HYBRIDS

NEMA 23 FRAME (2.3" Dia.)—Ratings and Characteristics

Review the Model Number Code, page 55, to assure that all options are designated. Connections, encoders and phasing diagrams start on page 76. Motor dimensions are on page 60. In addition to those below, motors with characteristics for specific performance requirements are offered. Contact factory for more details.

Rated currents are in descending order	Motor Model Number Δ	Connection Δ		Holding Torque Δ (2 phases on) oz-in (Nm) $\pm 10\%$	Rated Current/Phase Δ (amps DC)	Phase Resistance (ohms) $\pm 10\%$	Phase Inductance Δ (mH) Typical	Detent Torque oz-in (Nm)	Thermal Resistance Δ (°C/watt)	Rotor Inertia oz-in-S ² (kgm ² x 10 ⁻³)	Weight lbs (kg)					
		Parallel Series	Unipolar													
Torque range: 148-225 oz-in. 1.05-1.59 Nm	E22NXHP-LXX-XX-00	•		210 (1.48)	6.7	0.19	0.5	↑	↑	↑	↑					
	E22NXLP-LXX-XX-00	•		210 (1.48)	3.4	0.68	2.1									
	E22NXEP-LXX-XX-00		•	148 (1.05)	4.7	0.35	0.5									
	<hr/>															
	SIGMAX® E22 Series 2 rotor stacks	E22NXHC-LXX-XX-00	•		218 (1.54)	6.4	0.21					0.6				
		E22NXLC-LXX-XX-00		•	218 (1.54)	3.2	0.73					2.5				
		E22NXEC-LXX-XX-00		•	154 (1.09)	4.5	0.38					0.6				
	<hr/>															
		E22NXHT-LXX-XX-00	•		223 (1.58)	5.0	0.33					1.1	9.6 (0.068)	4.4	0.0031 (0.022)	2.1 (0.95)
	E22NXLT-LXX-XX-00		•	223 (1.58)	2.5	1.2	4.5									
	E22NXET-LXX-XX-00		•	158 (1.12)	3.5	0.62	1.1									
<hr/>																
	E22NXHB-LXX-XX-00	•		225 (1.59)	3.1	0.79	2.9	↓	↓	↓	↓					
	E22NXLB-LXX-XX-00		•	225 (1.59)	1.6	3.07	11.8									
	E22NXEB-LXX-XX-00		•	159 (1.12)	2.2	1.55	2.9									
<hr/>																
	E22NXHD-LXX-XX-00	•		225 (1.59)	2.4	1.25	4.7	↓	↓	↓	↓					
	E22NXLD-LXX-XX-00		•	225 (1.59)	1.22	4.91	19.0									
	E22NXED-LXX-XX-00		•	159 (1.12)	1.72	2.47	4.7									
<hr/>																
Torque range: 103-156 oz-in. .73-1.10 Nm	H22NXHP-LXX-XX-00	•		146 (1.03)	6.7	0.19	0.6	↑	↑	↑	↑					
	H22NXLP-LXX-XX-00	•		146 (1.03)	3.4	0.68	2.4									
	H22NXEP-LXX-XX-00		•	103 (0.73)	4.7	0.35	0.6									
	<hr/>															
	STANDARD H22 Series 2 rotor stacks	H22NXHC-LXX-XX-00	•		151 (1.07)	6.4	0.21					0.7				
		H22NXLC-LXX-XX-00		•	151 (1.07)	3.2	0.73					2.9				
		H22NXEC-LXX-XX-00		•	107 (0.75)	4.5	0.38					0.7				
	<hr/>															
		H22NXHT-LXX-XX-00	•		155 (1.09)	5.0	0.33					1.3	4.6 (0.032)	4.4	0.0031 (0.022)	2.1 (0.95)
	H22NXLT-LXX-XX-00		•	155 (1.09)	2.5	1.2	5.1									
	H22NXET-LXX-XX-00		•	109 (0.77)	3.5	0.62	1.3									
<hr/>																
	H22NXHB-LXX-XX-00	•		156 (1.10)	3.1	0.79	3.4	↓	↓	↓	↓					
	H22NXLB-LXX-XX-00		•	156 (1.10)	1.54	3.07	13.5									
	H22NXEB-LXX-XX-00		•	110 (0.78)	2.2	1.55	3.4									
<hr/>																
	H22NXHD-LXX-XX-00	•		156 (1.10)	2.4	1.25	5.5	↓	↓	↓	↓					
	H22NXLD-LXX-XX-00		•	156 (1.10)	1.22	4.91	21.8									
	H22NXED-LXX-XX-00		•	110 (0.78)	1.72	2.47	5.5									

All ratings typical and at 25°C unless otherwise noted.

- Δ An "X" in the Model Number Code indicates an undefined option. Colored letter indicates winding. See How to Order and Model Number Code on page 55.
- Δ Motor connections are determined by the Windings/Leads designation in the Model Number Code on page 55. Note that the F designation, although not shown in the above tables, is an 8-lead option...see Terminations, page 76. In addition to the lead wire termination, terminal board and MS connector hookup for parallel, series or unipolar operation is also available.

- Δ With rated current applied. Windings at 130°C and motor unmounted and in still air at 40°C (without heat sink).
- Δ Windings at 130°C and motor in still air at 40°C (without heat sink). Operation of these motors above rated current may cause demagnetization. Contact factory.
- Δ Small signal inductance as measured with impedance bridge at 1kHz, 1 amp.
- Δ Thermal resistance measured with motor hanging in still air (unmounted).

DIMENSIONS . . . GENERAL PURPOSE—CONVENTIONAL HYBRIDS

$\frac{\text{in.}}{\text{mm}}$ (metric dimensions for ref. only)
mm

NEMA 23 FRAME

(See page 76 for Technical Data)

REGULAR CONSTRUCTION/LEADWIRE HOOKUP=R

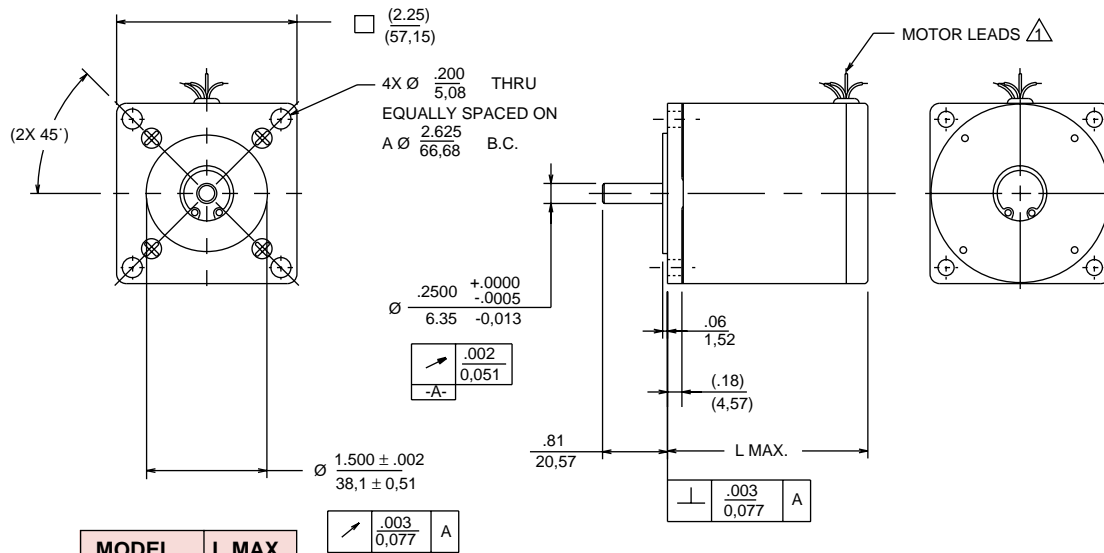

MODEL NUMBER	L MAX.
2HNR	1.56 39,63
21NR	2.06 52,33
22NR	3.06 77,73

STANDARD OPTIONS

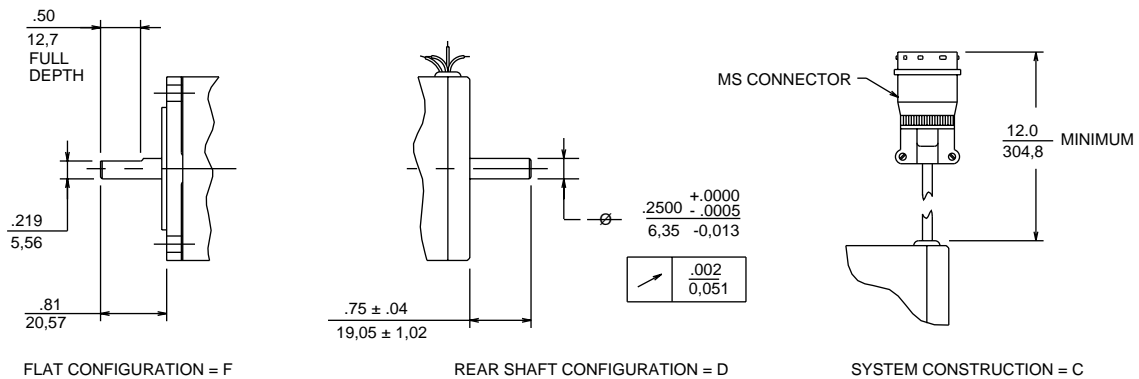

ENCODER OPTION

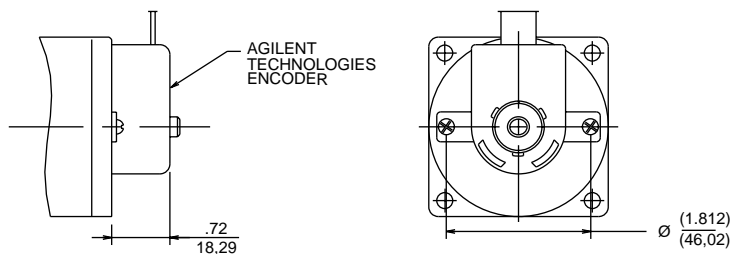

NOTE:

\triangle MOTOR LEADS: #22 AWG, 12.0 MINIMUM.
304.8

GENERAL PURPOSE— CONVENTIONAL HYBRIDS NEMA 34 FRAME (3.4" Dia.)

MODEL NUMBER CODE

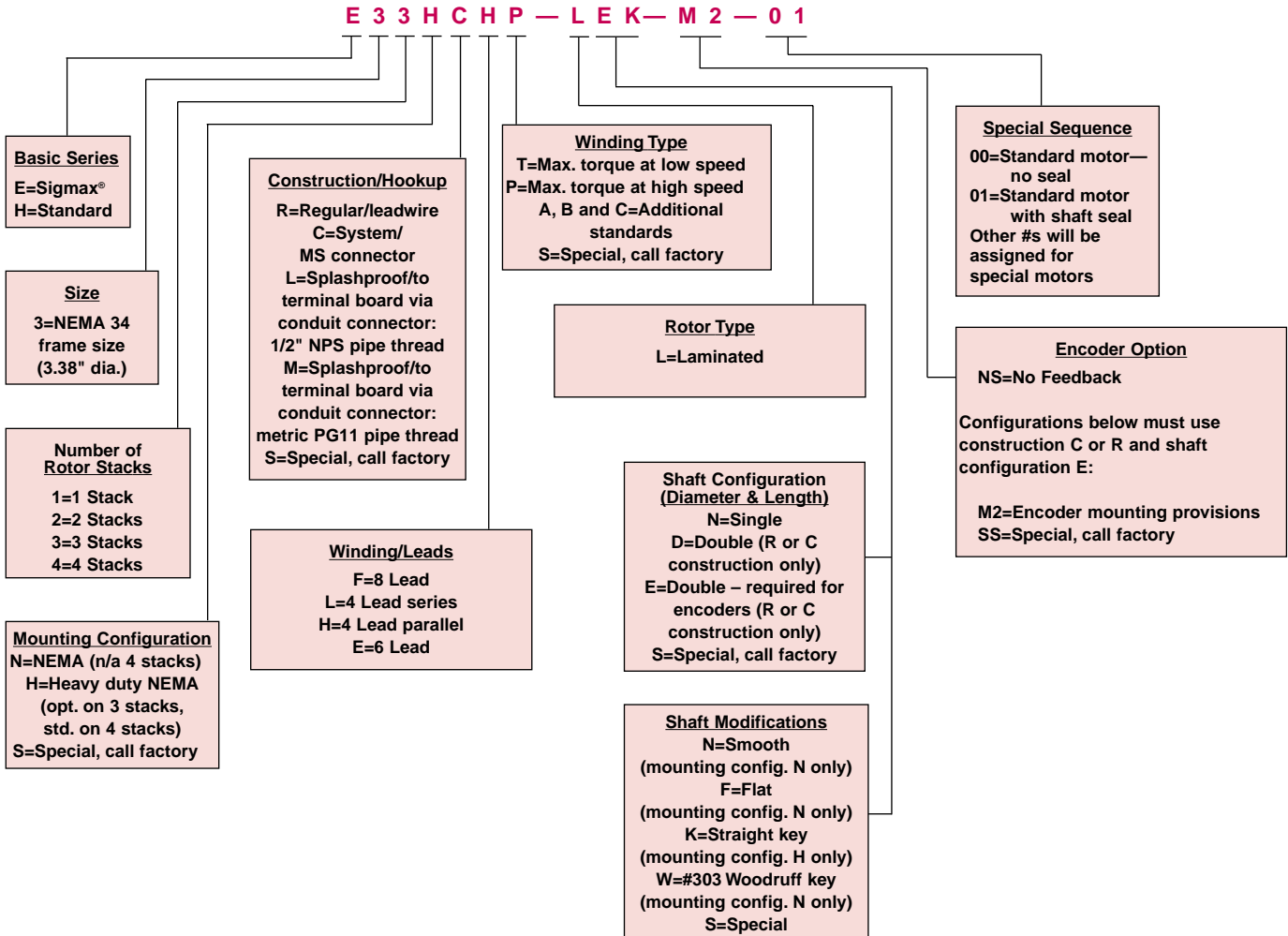

The example model number above indicates an E series (Sigmax®) NEMA 34 frame motor with a three stack rotor. This motor is equipped with heavy duty front end bell and shaft, and sealed system rear end bell with MS connectors. It also has a bipolar parallel connection, a maximum torque at high speed winding, a straight keyway, encoder mounting provisions and a shaft seal.

HOW TO ORDER

Review the Motor Model Number Code above to assure that all options are designated. Connections, encoders and phasing diagrams start on page 76. Motor dimensions start on page 65.

GENERAL PURPOSE—CONVENTIONAL HYBRIDS

NEMA 34 FRAME (3.4" Dia.)—Ratings and Characteristics

Review the Model Number Code, page 61, to assure that all options are designated. Connections, encoders and phasing diagrams start on page 76. Motor dimensions start on page 65. In addition to those below, motors with characteristics for specific performance requirements are offered. Contact factory for more details.

Rated currents are in descending order	Motor Model Number Δ	Connection Δ			Holding Torque Δ (2 phases on) oz-in (Nm) $\pm 10\%$	Rated Current/Phase Δ (amps DC)	Phase Resistance (ohms) $\pm 10\%$	Phase Inductance Δ (mH) Typical	Detent Torque oz-in (Nm)	Thermal Resistance Δ (°C/watt)	Rotor Inertia oz-in-S ² (kgm ² x 10 ⁻³)	Weight lbs (kg)					
		Parallel	Series	Unipolar													
Torque range: 223-349 oz-in. 1.58-1.90 Nm	E31NXHP-LXX-XX-00	•			344 (2.43)	8.4	0.13	1.1	↑	↑	↑	↑					
	E31NXLP-LXX-XX-00		•		344 (2.43)	4.2	0.52	4.4									
	E31NXEP-LXX-XX-00			•	243 (1.72)	5.9	0.27	1.1									
	SIGMAX®																
	E31 Series																
	1 rotor stack																
	E31NXHA-LXX-XX-00	•			349 (2.47)	8.2	0.14	1.2									
	E31NXLA-LXX-XX-00		•		349 (2.47)	4.1	0.55	4.9									
	E31NXEA-LXX-XX-00			•	247 (1.74)	5.8	0.28	1.2									
E31NXHB-LXX-XX-00	•			316 (2.23)	5.9	0.24	1.7	22 (0.16)	3.9	0.0083 (0.059)	3.2 (1.45)						
E31NXLB-LXX-XX-00		•		316 (2.23)	3.0	0.94	6.9										
E31NXEB-LXX-XX-00			•	224 (1.58)	4.2	0.50	1.7										
E31NXHT-LXX-XX-00	•			337 (2.38)	5.4	0.29	2.5	↓	↓	↓	↓						
E31NXLT-LXX-XX-00		•		337 (2.38)	2.7	1.12	10.0										
E31NXET-LXX-XX-00			•	238 (1.68)	3.8	0.59	2.5										
E31NXHC-LXX-XX-00	•			316 (2.23)	3.0	0.94	6.9	↓	↓	↓	↓						
E31NXLC-LXX-XX-00		•		316 (2.23)	1.48	3.73	27.6										
E31NXEC-LXX-XX-00			•	223 (1.58)	2.1	1.89	6.9										
Torque range: 158-186 oz-in. 1.12-1.71 Nm	H31NXHP-LXX-XX-00	•			239 (1.69)	8.4	0.13	1.0	↑	↑	↑	↑					
	H31NXLP-LXX-XX-00		•		239 (1.69)	4.2	0.52	4.0									
	H31NXEP-LXX-XX-00			•	169 (1.20)	5.9	0.27	1.0									
	STANDARD																
	H31 Series																
	1 rotor stack																
	H31NXHA-LXX-XX-00	•			242 (1.71)	8.2	0.14	1.1									
	H31NXLA-LXX-XX-00		•		242 (1.71)	4.1	0.50	4.5									
	H31NXEA-LXX-XX-00			•	171 (1.21)	5.8	0.28	1.1									
	H31NXHB-LXX-XX-00	•			224 (1.58)	5.9	0.24	1.6					8.8 (0.062)	3.9	0.0083 (0.059)	3.2 (1.45)	
	H31NXLB-LXX-XX-00		•		224 (1.58)	3.0	0.94	6.4									
	H31NXEB-LXX-XX-00			•	158 (1.12)	4.2	0.50	1.6									
	H31NXHT-LXX-XX-00	•			236 (1.66)	5.4	0.29	2.3					↓	↓	↓	↓	
	H31NXLT-LXX-XX-00		•		236 (1.66)	2.7	1.12	9.3									
	H31NXET-LXX-XX-00			•	167 (1.18)	3.8	0.59	2.3									
	H31NXHC-LXX-XX-00	•			224 (1.58)	3.0	0.94	6.4					↓	↓	↓	↓	
	H31NXLC-LXX-XX-00		•		224 (1.58)	1.48	3.73	25.8									
	H31NXEC-LXX-XX-00			•	158 (1.12)	2.1	1.89	6.4									

All ratings typical and at 25°C unless otherwise noted.

- Δ An "X" in the Model Number Code indicates an undefined option. Colored letter indicates winding. See How to Order and Model Number Code on page 61.
- Δ Motor connections are determined by the Windings/Leads designation in the Model Number Code on page 61. Note that the F designation, although not shown in the above tables, is an 8-lead option...see Terminations, page 76. In addition to the lead wire termination, terminal board and MS connector hookup for parallel, series or unipolar operation is also available.

- Δ With rated current applied. Windings at 130°C and motor unmounted and in still air at 40°C (without heat sink).
- Δ Windings at 130°C and motor in still air at 40°C (without heat sink). Operation of these motors above rated current may cause demagnetization. Contact factory.
- Δ Small signal inductance as measured with impedance bridge at 1kHz, 1 amp.
- Δ Thermal resistance measured with motor hanging in still air (unmounted).

GENERAL PURPOSE—CONVENTIONAL HYBRIDS

NEMA 34 FRAME (3.4" Dia.)—Ratings and Characteristics (Con't)

Review the Model Number Code, page 61, to assure that all options are designated. Connections, encoders and phasing diagrams start on page 76. Motor dimensions start on page 65. In addition to those below, motors with characteristics for specific performance requirements are offered. Contact factory for more details.

Rated currents are in descending order	Motor Model Number Δ	Connection Δ		Holding Torque Δ (2 phases on) oz-in (Nm) $\pm 10\%$	Rated Current/Phase Δ (amps DC)	Phase Resistance (ohms) $\pm 10\%$	Phase Inductance Δ (mH) Typical	Detent Torque oz-in (Nm)	Thermal Resistance Δ (°C/watt)	Rotor Inertia oz-in-S ² (kgm ² x 10 ⁻³)	Weight lbs (kg)								
		Parallel Series	Unipolar																
Torque range: 443-673 oz-in. 3.13-4.75 Nm	E32NXHP-LXX-XX-00	•		673 (4.75)	8.1	0.19	2.2	↑	↑	↑	↑								
	E32NXLP-LXX-XX-00	•		673 (4.75)	4.1	0.74	8.9												
	E32NXEP-LXX-XX-00		•	476 (3.36)	5.7	0.39	2.2												
	SIGMAX®																		
	E32 Series																		
	2 rotor stacks																		
	E32NXHA-LXX-XX-00	•		627 (4.43)	5.6	0.39	3.7					42 (0.3)	2.7	0.0170 (0.120)	5.3 (2.41)				
	E32NXLA-LXX-XX-00		•	627 (4.43)	2.8	1.51	15.0												
	E32NXEA-LXX-XX-00		•	443 (3.13)	4.0	0.78	3.7												
STANDARD																			
H32 Series																			
2 rotor stacks																			
E32NXHT-LXX-XX-00	•		659 (4.66)	5.2	0.44	5.0	↓	↓	↓	↓									
E32NXLT-LXX-XX-00		•	659 (4.66)	2.6	1.74	19.9													
E32NXET-LXX-XX-00		•	466 (3.29)	3.7	0.89	5.0													
Torque range: 314-471 oz-in. 2.22-3.32 Nm																			
H32NXHP-LXX-XX-00	•		471 (3.32)	8.1	0.19	2.4					↑	↑	↑	↑					
H32NXLP-LXX-XX-00		•	471 (3.32)	4.1	0.74	9.6													
H32NXEP-LXX-XX-00		•	333 (2.35)	5.7	0.39	2.4													
STANDARD																			
H32 Series																			
2 rotor stacks																			
H32NXHA-LXX-XX-00	•		445 (3.14)	5.6	0.39	4.1	18 (0.3)	2.7	0.0170 (0.120)	5.3 (2.41)									
H32NXLA-LXX-XX-00		•	445 (3.14)	2.8	1.51	16.2													
H32NXEA-LXX-XX-00		•	314 (2.22)	4.0	0.78	4.1													
Torque range: 656-995 oz-in. 4.63-5.40 Nm																			
E33NXHC-LXX-XX-00	•		927 (6.55)	11.1	0.15	1.3					↑	↑	↑	↑					
E33NXLC-LXX-XX-00		•	927 (6.55)	5.5	0.59	5.3													
E33NXEC-LXX-XX-00		•	656 (4.63)	7.8	0.29	1.3													
SIGMAX®																			
E33 Series																			
3 rotor stacks																			
E33NXHA-LXX-XX-00	•		940 (6.64)	8.6	0.23	2.3	64 (0.45)	2.0	.0250 (0.176)	7.6 (3.45)									
E33NXLA-LXX-XX-00		•	940 (6.64)	4.3	0.87	9.1													
E33NXEA-LXX-XX-00		•	664 (4.69)	6.1	0.46	2.3													
Torque range: 656-995 oz-in. 4.63-5.40 Nm																			
E33NXHP-LXX-XX-00	•		995 (7.02)	7.9	0.26	3.1					↓	↓	↓	↓					
E33NXLP-LXX-XX-00		•	995 (7.02)	4.0	1.02	12.6													
E33NXEP-LXX-XX-00		•	703 (4.97)	5.6	0.54	3.1													
STANDARD																			
E33 Series																			
3 rotor stacks																			
E33NXHB-LXX-XX-00	•		939 (6.63)	5.4	0.55	5.7	↓	↓	↓	↓									
E33NXLB-LXX-XX-00		•	939 (6.63)	2.7	2.17	22.9													
E33NXEB-LXX-XX-00		•	664 (4.69)	3.8	1.11	5.7													
Torque range: 656-995 oz-in. 4.63-5.40 Nm																			
E33NXHT-LXX-XX-00	•		975 (6.88)	5.1	0.61	7.1					↓	↓	↓	↓					
E33NXLT-LXX-XX-00		•	975 (6.88)	2.6	2.41	28.2													
E33NXET-LXX-XX-00		•	689 (4.87)	3.6	1.23	7.1													

All ratings typical and at 25°C unless otherwise noted.

Δ An "X" in the Model Number Code indicates an undefined option. Colored letter indicates winding. See How to Order and Model Number Code on page 61.

Δ Motor connections are determined by the Windings/Leads designation in the Model Number Code on page 61. Note that the F designation, although not shown in the above tables, is an 8-lead option...see Terminations, page 76. In addition to the lead wire termination, terminal board and MS connector hookup for parallel, series or unipolar operation is also available.

Δ With rated current applied. Windings at 130°C and motor unmounted and in still air at 40°C (without heat sink).

Δ Windings at 130°C and motor in still air at 40°C (without heat sink). Operation of these motors above rated current may cause demagnetization. Contact factory.

Δ Small signal inductance as measured with impedance bridge at 1kHz, 1 amp.

Δ Thermal resistance measured with motor hanging in still air (unmounted).

GENERAL PURPOSE—CONVENTIONAL HYBRIDS

NEMA 34 FRAME (3.4" Dia.)—Ratings and Characteristics (Con't.)

Review the Model Number Code, page 61, to assure that all options are designated. Connections, encoders and phasing diagrams start on page 76. Motor dimensions start on page 65. In addition to those below, motors with characteristics for specific performance requirements are offered. Contact factory for more details.

Rated currents are in descending order	Motor Model Number Δ	Connection Δ			Holding Torque Δ (2 phases on) oz-in (Nm) $\pm 10\%$	Rated Current/Phase Δ (amps DC)	Phase Resistance (ohms) $\pm 10\%$	Phase Inductance Δ (mH) Typical	Detent Torque oz-in (Nm)	Thermal Resistance Δ (°C/watt)	Rotor Inertia oz-in-S ² (kgm ² x 10 ⁻³)	Weight lbs (kg)					
		Parallel	Series	Unipolar													
Torque range: 466-698 oz-in. 3.29-4.93 Nm	H33XXHC-LXX-XX-00	•			659 (4.65)	11.1	0.15	1.6	↑	↑	↑	↑					
	H33XXLC-LXX-XX-00	•			659 (4.65)	5.5	0.59	6.3									
	H33XXEC-LXX-XX-00		•		466 (3.29)	7.8	0.29	1.6									
	STANDARD																
	H33 Series																
	3 rotor stacks																
	H33XXHA-LXX-XX-00	•			666 (4.70)	8.6	0.23	2.7									
	H33XXLA-LXX-XX-00	•			666 (4.70)	4.3	0.87	10.8									
	H33XXEA-LXX-XX-00		•		471 (3.33)	6.1	0.46	2.7									
	H33XXHB-LXX-XX-00	•			666 (4.70)	5.4	0.55	6.8									
	H33XXLB-LXX-XX-00	•			666 (4.70)	2.7	2.17	27.2									
	H33XXEB-LXX-XX-00		•		471 (3.33)	3.8	1.11	6.8									
	H33XXHT-LXX-XX-00	•			687 (4.85)	5.1	0.61	8.4									
	H33XXLT-LXX-XX-00	•			687 (4.85)	2.6	2.41	33.6									
	H33XXET-LXX-XX-00		•		468 (3.43)	3.6	1.23	8.4									
H33XXHP-LXX-XX-00	•			698 (4.93)	7.9	0.26	3.7										
H33XXLP-LXX-XX-00	•			698 (4.93)	4.0	1.02	14.9										
H33XXEP-LXX-XX-00		•		494 (3.49)	5.6	0.54	3.7										
Torque range: 879-1300 oz-in. 6.21-9.18 Nm	E34HXHA-LXX-XX-00	•			1253 (8.85)	8.1	0.29	3.6	↑	↑	↑	↑					
	E34HXLA-LXX-XX-00	•			1253 (8.85)	4.1	1.14	13.7									
	E34HXEA-LXX-XX-00		•		886 (6.26)	5.7	0.60	3.6									
	SIGMAX®																
	E34 Series																
	4 rotor stacks																
	E34HXHP-LXX-XX-00	•			1300 (9.18)	7.7	0.33	4.4									
	E34HXLP-LXX-XX-00	•			1300 (9.18)	3.9	1.27	17.8									
	E34HXEP-LXX-XX-00		•		920 (6.49)	5.5	0.66	4.4									
	E34HXHT-LXX-XX-00	•			1243 (8.78)	5.2	0.71	8.7									
	E34HXLT-LXX-XX-00	•			1243 (8.78)	2.6	2.8	34.8									
	E34HXET-LXX-XX-00		•		879 (6.21)	3.7	1.43	8.7									
	H34HXHA-LXX-XX-00	•			888 (6.27)	8.1	0.29	3.8									
	H34HXLA-LXX-XX-00	•			888 (6.27)	4.1	1.14	15.1									
	H34HXEA-LXX-XX-00		•		628 (4.44)	5.7	0.60	3.8									
STANDARD																	
H34 Series																	
4 rotor stacks																	
H34HXHP-LXX-XX-00	•			916 (6.47)	7.7	0.33	4.7										
H34HXLP-LXX-XX-00	•			916 (6.47)	3.9	1.27	18.6										
H34HXEP-LXX-XX-00		•		648 (4.57)	5.5	0.66	4.7										
H34HXHT-LXX-XX-00	•			882 (6.23)	5.2	0.71	9.1										
H34HXLT-LXX-XX-00	•			882 (6.23)	2.6	2.8	36.5										
H34HXET-LXX-XX-00		•		624 (4.41)	3.7	1.43	9.1										

All ratings typical and at 25°C unless otherwise noted.

Δ An "X" in the Model Number Code indicates an undefined option. Colored letter indicates winding. See How to Order and Model Number Code on page 61.

Δ Motor connections are determined by the Windings/Leads designation in the Model Number Code on page 61. Note that the F designation, although not shown in the above tables, is an 8-lead option...see Terminations, page 76. In addition to the lead wire termination, terminal board and MS connector hookup for parallel, series or unipolar operation is also available.

Δ With rated current applied. Windings at 130°C and motor unmounted and in still air at 40°C (without heat sink).

Δ Windings at 130°C and motor in still air at 40°C (without heat sink). Operation of these motors above rated current may cause demagnetization. Contact factory.

Δ Small signal inductance as measured with impedance bridge at 1kHz, 1 amp.

Δ Thermal resistance measured with motor hanging in still air (unmounted).

DIMENSIONS . . . GENERAL PURPOSE—CONVENTIONAL HYBRIDS

$\frac{\text{in.}}{\text{mm}}$ (metric dimensions for ref. only)

NEMA 34 FRAME

(See page 76 for Technical Data)

REGULAR CONSTRUCTION/LEADWIRE HOOKUP = R

STANDARD NEMA FRONT END BELL = N

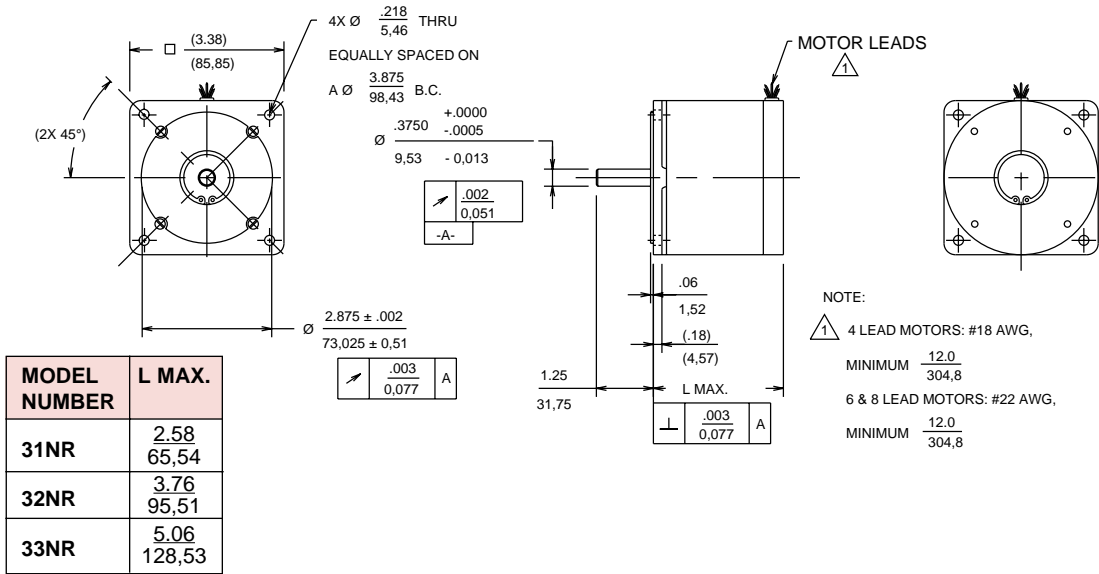

HEAVY DUTY NEMA FRONT END BELL = H

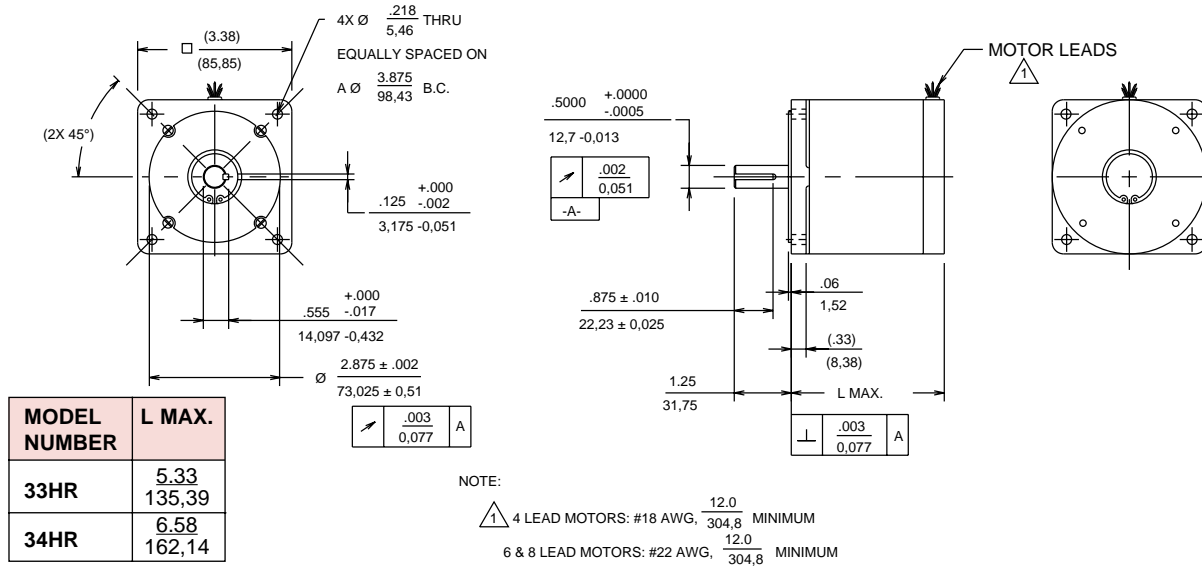

STANDARD FRONT SHAFT CONFIGURATIONS

NOTE: Not available with heavy duty

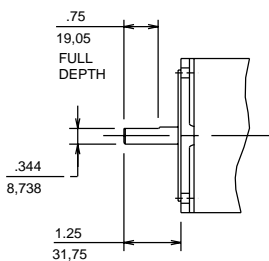

FLAT CONFIGURATION = F

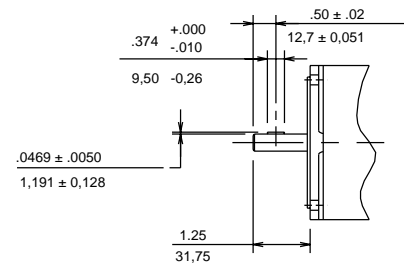

#303 WOODRUFF KEY CONFIGURATION = W

STANDARD DOUBLE SHAFT CONFIGURATION

NOTE: Not available with splashproof

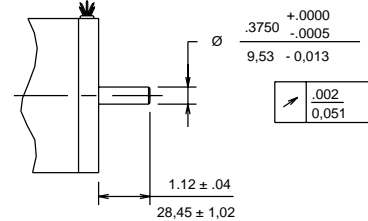

REAR SHAFT CONFIGURATION = D

DIMENSIONS . . . GENERAL PURPOSE—CONVENTIONAL HYBRIDS

$\frac{\text{in.}}{\text{mm}}$ (metric dimensions for ref. only)

NEMA 34 FRAME (Con't.)

(See page 76 for Technical Data)

SPLASHPROOF CONSTRUCTION/TERMINAL BOARD CONNECTIONS = L or M

STANDARD NEMA FRONT END BELL = N

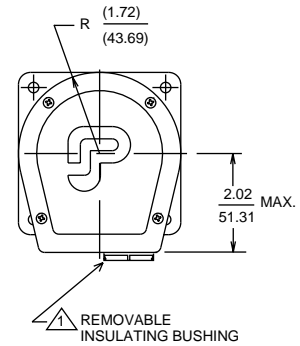
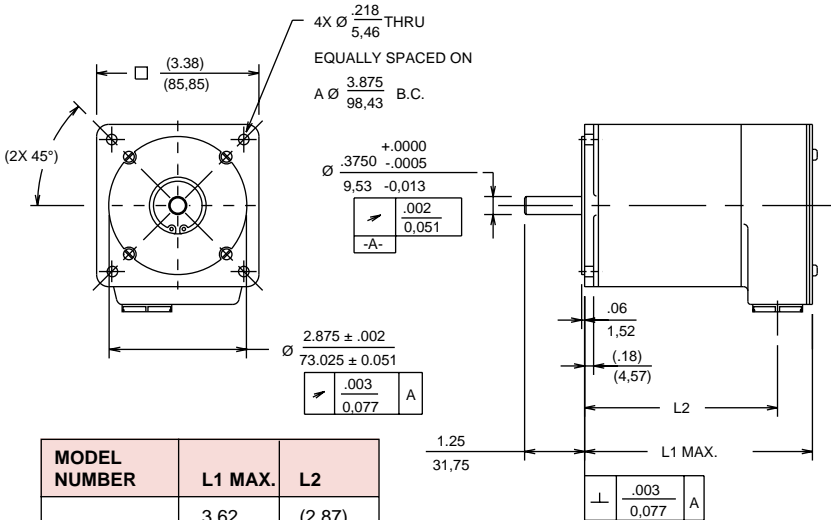

NOTE:

- △ L Construction = Conduit connection (1/2 NPSC TAP) with $\frac{.56}{14.2}$ I.D. removable insulating bushing
- M Construction = Conduit connection (PG 11 TAP). (No insulating bushing supplied)
- 2 Standard front shaft configuration options, refer to page 65.

MODEL NUMBER	L1 MAX.	L2
31N(L OR M)	$\frac{3.62}{91.95}$	$\frac{(2.87)}{(72,9)}$
32N(L OR M)	$\frac{4.77}{121,16}$	$\frac{(4.02)}{(102,11)}$
33N(L OR M)	$\frac{6.05}{153,67}$	$\frac{(5.30)}{(134,62)}$

HEAVY DUTY NEMA FRONT END BELL = H

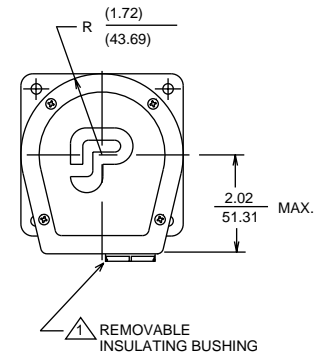
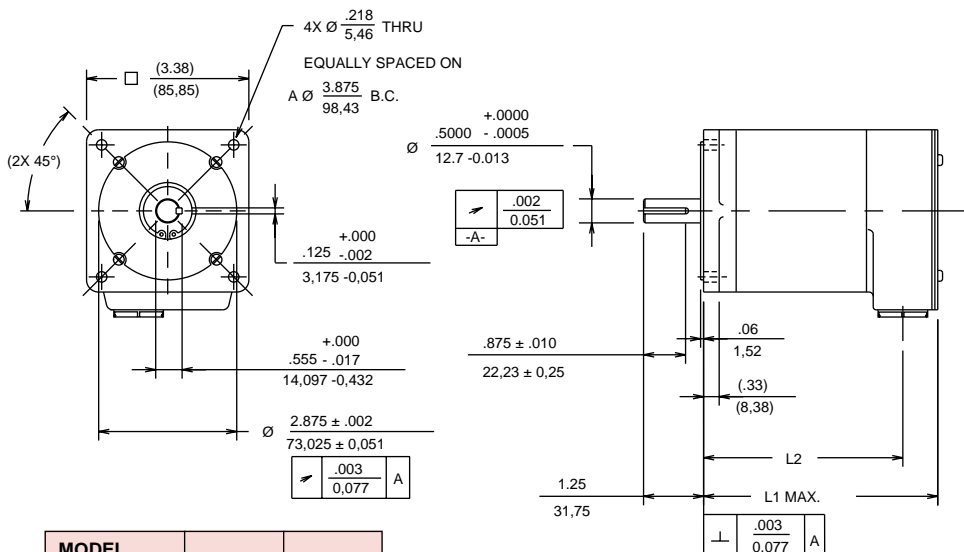

NOTE:

- △ L Construction = Conduit connection (1/2 NPSC TAP) with $\frac{.56}{14.2}$ I.D. removable insulating bushing
- M Construction = Conduit connection (PG 11 TAP). (No insulating bushing supplied)

MODEL NUMBER	L1 MAX.	L2
33H(L OR M)	$\frac{6.73}{170,94}$	$\frac{(5.61)}{(142,49)}$
34H(L OR M)	$\frac{7.62}{193,55}$	$\frac{(6.86)}{(174,24)}$

DIMENSIONS . . . GENERAL PURPOSE—CONVENTIONAL HYBRIDS

$\frac{\text{in.}}{\text{mm}}$ (metric dimensions for ref. only)

NEMA 34 FRAME (Con't.)

(See page 76 for Technical Data)

SYSTEM CONSTRUCTION/MS CONNECTOR = C ENCODER OPTION

STANDARD NEMA FRONT END BELL = N

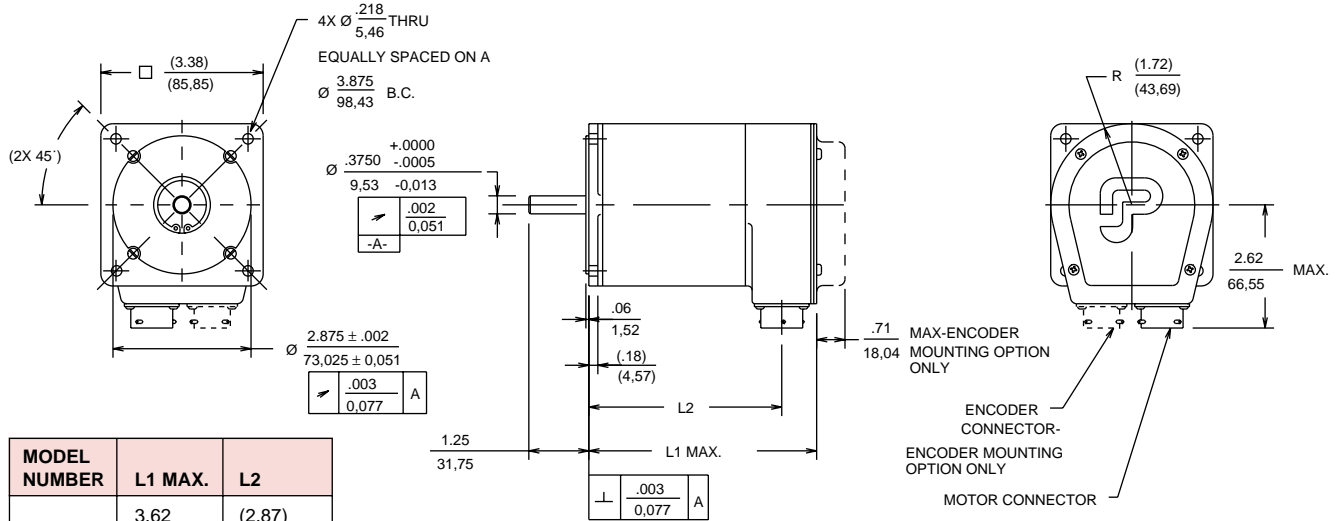

NOTE: Standard front shaft configuration options, refer to page 65.

HEAVY DUTY NEMA FRONT END BELL = H

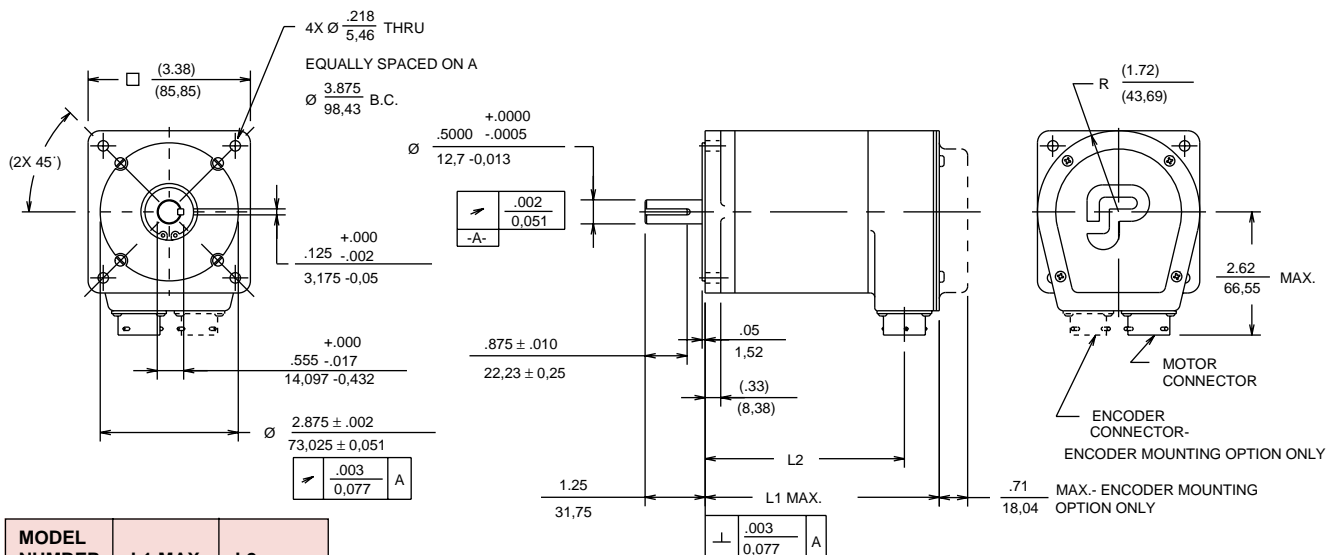

GENERAL PURPOSE— CONVENTIONAL HYBRIDS NEMA 42 FRAME (4.2" Dia.)

MODEL NUMBER CODE

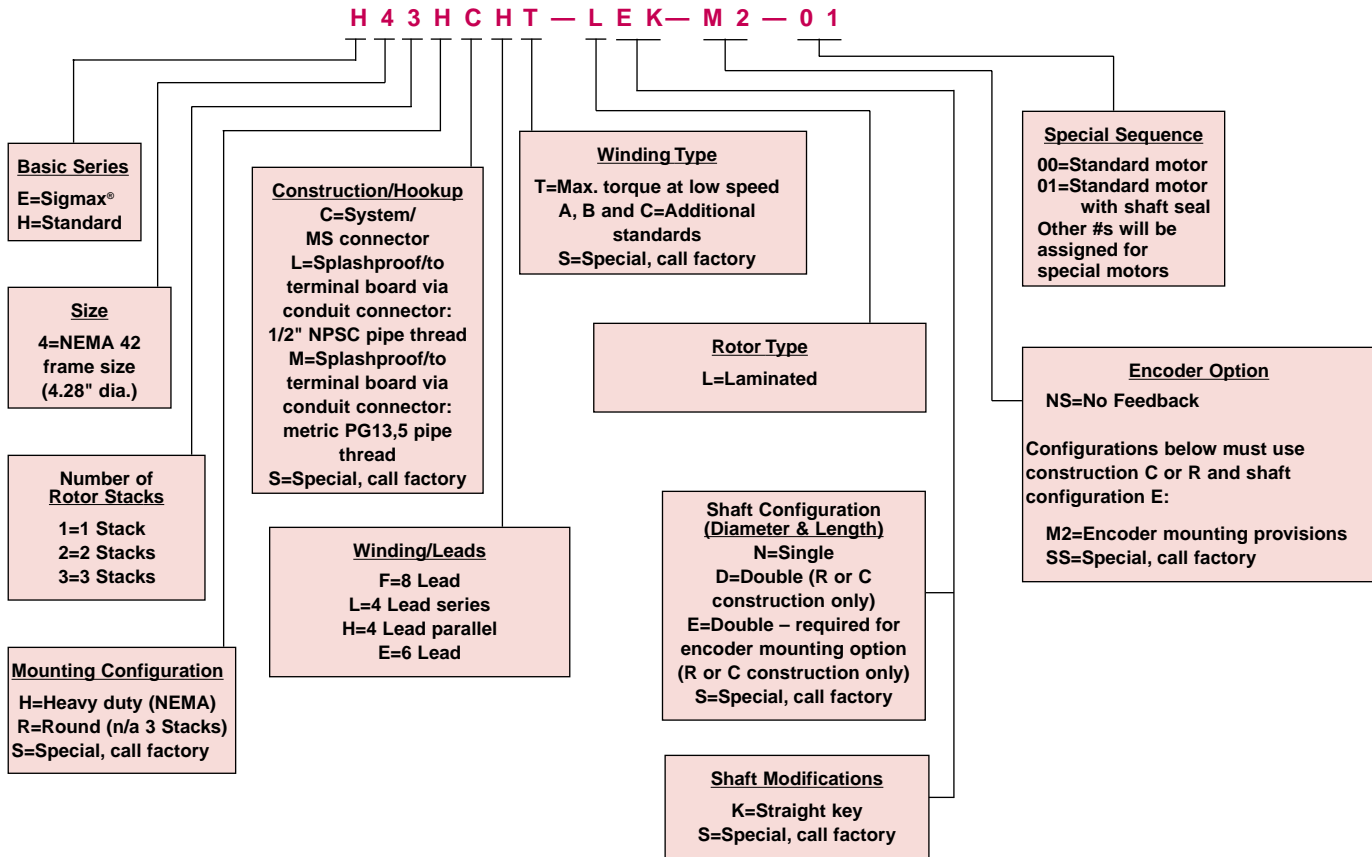

The example model number above indicates a standard NEMA 42 frame motor with a three stack rotor. This motor is equipped with the standard heavy duty NEMA front end bell and shaft, and a sealed system rear end bell with MS connectors. It also has a bipolar parallel connection, a maximum torque at low speed winding, shaft seal, straight keyway and encoder mounting provisions.

HOW TO ORDER

Review the Motor Model Number Code to assure that all options are designated. Connections, encoders and phasing diagrams start on page 76. Motor dimensions are on page 72.

GENERAL PURPOSE—CONVENTIONAL HYBRIDS

NEMA 42 FRAME (4.2" Dia.)—Ratings and Characteristics

Review the Model Number Code, page 68, to assure that all options are designated. Connections, encoders and phasing diagrams start on page 76. Motor dimensions are on page 72. In addition to those below, motors with characteristics for specific performance requirements are offered. Contact factory for more details.

Rated currents are in descending order	Motor Model Number [△]	Connection [△]		Holding Torque [△] (2 phases on oz-in (Nm) ±10%)	Rated Current/Phase [△] (amps DC)	Phase Resistance (ohms) ±10%	Phase Inductance [△] (mH) Typical	Detent Torque oz-in (Nm)	Thermal Resistance [△] (°C/watt)	Rotor Inertia oz-in-S ² (kgm ² x 10 ⁻³)	Weight lbs (kg)		
		Parallel	Series									Unipolar	
Torque range: 957-1378 oz-in. 6.76-9.73 Nm	E41HXHA-LXX-XX-00	•		1378 (9.73)	10.6	0.16	2.5	↑	↑	↑	↑		
	E41HXLA-LXX-XX-00	•		1378 (9.73)	5.3	0.64	10.0						
	E41HXEA-LXX-XX-00		•	974 (6.88)	7.5	0.32	2.5						
	SIGMAX® E41 Series 1 rotor stack	E41HXHT-LXX-XX-00	•		1353 (9.55)	5.4	0.61	9.0	58 (0.41)	1.8	0.0800 (0.565)	10.9 (4.94)	
		E41HXLT-LXX-XX-00	•		1353 (9.55)	2.7	2.41	36.1					
		E41HXET-LXX-XX-00		•	957 (6.76)	3.8	1.21	9.0					
			E41HXHB-LXX-XX-00	•		1377 (9.72)	5.3	0.64	10.0	↓	↓	↓	↓
			E41HXLB-LXX-XX-00	•		1377 (9.72)	2.7	2.54	40.0				
			E41HXEB-LXX-XX-00		•	974 (6.88)	3.7	1.27	10.0				
Torque range: 585-839 oz-in. 4.13-5.93 Nm		H41HXHA-LXX-XX-00	•		839 (5.93)	10.6	0.16	3.1	↑	↑	↑	↑	
		H41HXLA-LXX-XX-00	•		839 (5.93)	5.3	0.64	12.4					
		H41HXEA-LXX-XX-00		•	593 (4.19)	7.5	0.32	3.1					
	STANDARD H41 Series 1 rotor stack	H41HXHT-LXX-XX-00	•		828 (5.84)	5.4	0.61	11.2	31 (0.22)	1.8	0.0800 (0.565)	10.9 (4.94)	
		H41HXLT-LXX-XX-00	•		828 (5.84)	2.7	2.41	44.6					
		H41HXET-LXX-XX-00		•	585 (4.13)	3.8	1.21	11.2					
			H41HXHB-LXX-XX-00	•		839 (5.92)	5.3	0.64	12.4	↓	↓	↓	↓
			H41HXLB-LXX-XX-00	•		839 (5.92)	2.7	2.54	49.4				
			H41HXEB-LXX-XX-00		•	593 (4.19)	3.7	1.27	12.4				

All ratings typical and at 25°C unless otherwise noted.

- [△] An "X" in the Model Number Code indicates an undefined option. Colored letter indicates winding. See How to Order and Model Number Code on page 68.
- [△] Motor connections are determined by the Windings/Leads designation in the model Number Code on page 68. Note that the F designation, although not shown in the above tables, is an 8-lead option...see Terminations, page 76. In addition to the lead wire termination, terminal board and MS connector hookup for parallel, series or unipolar operation is also available.

- [△] With rated current applied. Windings at 130°C and motor unmounted and in still air at 40°C (without heat sink).
- [△] Windings at 130°C and motor in still air at 40°C (without heat sink). Operation of these motors above rated current may cause demagnetization. Contact factory.
- [△] Small signal inductance as measured with impedance bridge at 1kHz, 1 amp.
- [△] Thermal resistance measured with motor hanging in still air (unmounted).

GENERAL PURPOSE—CONVENTIONAL HYBRIDS

NEMA 42 FRAME (4.2" Dia.)—Ratings and Characteristics (Con't.)

Review the Model Number Code, page 68, to assure that all options are designated. Connections, encoders and phasing diagrams start on page 76. Motor dimensions are on page 72. In addition to those below, motors with characteristics for specific performance requirements are offered. Contact factory for more details.

Rated currents are in descending order	Motor Model Number Δ	Connection Δ			Holding Torque Δ (2 phases on) oz-in (Nm) $\pm 10\%$	Rated Current/Phase Δ (amps DC)	Phase Resistance (ohms) $\pm 10\%$	Phase Inductance Δ (mH) Typical	Detent Torque oz-in (Nm)	Thermal Resistance Δ (°C/watt)	Rotor Inertia oz-in-S ² (kgm ² x 10 ⁻³)	Weight lbs (kg)				
		Parallel	Series	Unipolar												
Torque range: 1805-2698 oz-in. 12.75-19.06 Nm	E42HXHC-LXX-XX-00	•			2698 (19.06)	14.7	0.12	2.7	↑	↑	↑	↑				
	E42HXL C-LXX-XX-00	•			2698 (19.06)	7.4	0.47	10.6								
	E42HXEC-LXX-XX-00		•		1908 (13.48)	10.4	0.24	2.7								
	SIGMAX®															
	E42 Series															
	2 rotor stacks															
	E42HXHB-LXX-XX-00	•			2598 (18.34)	9.8	0.27	5.4					81 (0.57)	1.3	0.1600 (1.129)	18.2 (8.26)
	E42HXL B-LXX-XX-00	•			2598 (18.34)	4.9	1.07	21.7								
	E42HXEB-LXX-XX-00		•		1837 (12.97)	6.9	0.54	5.4								
E42HXHT-LXX-XX-00	•			2552 (18.02)	7.9	0.41	7.8									
E42HXLT-LXX-XX-00	•			2552 (18.02)	4.0	1.62	31.3									
E42HXET-LXX-XX-00		•		1805 (12.75)	5.6	0.81	7.8									
E42HXHA-LXX-XX-00	•			2693 (19.02)	5.9	0.74	16.6									
E42HXL A-LXX-XX-00	•			2693 (19.02)	2.9	2.96	66.5									
E42HXEA-LXX-XX-00		•		1904 (13.45)	4.1	1.48	16.6									
Torque range: 1118-1652 oz-in. 7.90-11.66 Nm	H42HXHC-LXX-XX-00	•			1652 (11.66)	14.7	0.12	3.3	↑	↑	↑	↑				
	H42HXL C-LXX-XX-00	•			1652 (11.66)	7.4	0.47	13.3								
	H42HXEC-LXX-XX-00		•		1168 (8.25)	10.4	0.24	3.3								
	STANDARD															
	H42 Series															
	2 rotor stacks															
	H42HXHB-LXX-XX-00	•			1604 (11.32)	9.8	0.27	6.8					50 (0.35)	1.3	0.1600 (1.129)	18.2 (8.26)
	H42HXL B-LXX-XX-00	•			1604 (11.32)	4.9	1.07	27.2								
	H42HXEB-LXX-XX-00		•		1134 (8.01)	6.9	0.54	6.8								
	H42HXHT-LXX-XX-00	•			1581 (11.17)	7.9	0.41	9.8								
	H42HXLT-LXX-XX-00	•			1581 (11.17)	4.0	1.62	39.2								
	H42HXET-LXX-XX-00		•		1118 (7.90)	5.6	0.81	9.8								
H42HXHA-LXX-XX-00	•			1649 (11.65)	5.9	0.74	20.8									
H42HXL A-LXX-XX-00	•			1649 (11.65)	2.9	2.96	83.4									
H42HXEA-LXX-XX-00		•		1166 (8.24)	4.1	1.48	20.8									

- All ratings typical and at 25°C unless otherwise noted.
- Δ An "X" in the Model Number Code indicates an undefined option. Colored letter indicates winding. See How to Order and Model Number Code on page 68.
 - Δ Motor connections are determined by the Windings/Leads designation in the Model Number Code on page 68. Note that the F designation, although not shown in the above tables, is an 8-lead option...see Terminations, page 76. In addition to the lead wire termination, terminal board and MS connector hookup for parallel, series or unipolar operation is also available.
 - Δ With rated current applied. Windings at 130°C and motor unmounted and in still air at 40°C (without heat sink).
 - Δ Windings at 130°C and motor in still air at 40°C (without heat sink). Operation of these motors above rated current may cause demagnetization. Contact factory.
 - Δ Small signal inductance as measured with impedance bridge at 1kHz, 1 amp.
 - Δ Thermal resistance measured with motor hanging in still air (unmounted).

GENERAL PURPOSE—CONVENTIONAL HYBRIDS

NEMA 42 FRAME (4.2" Dia.)—Ratings and Characteristics (Con't.)

Review the Model Number Code, page 68, to assure that all options are designated. Connections, encoders and phasing diagrams start on page 76. Motor dimensions are on page 72. In addition to those below, motors with characteristics for specific performance requirements are offered. Contact factory for more details.

Rated currents are in descending order	Motor Model Number Δ	Connection Δ		Holding Torque Δ (2 phases on) oz-in (Nm) $\pm 10\%$	Rated Current/Phase Δ (amps DC)	Phase Resistance (ohms) $\pm 10\%$	Phase Inductance Δ (mH) Typical	Detent Torque oz-in (Nm)	Thermal Resistance Δ (°C/watt)	Rotor Inertia oz-in-S ² (kgm ² x 10 ⁻³)	Weight lbs (kg)										
		Parallel Series	Unipolar																		
Torque range: 2667-3958 oz-in. 18.84-27.95 Nm	E43HXHC-LXX-XX-00	•		3722 (26.64)	13.3	0.21	3.7	↑	↑	↑	↑										
	E43HXL C-LXX-XX-00	•		3722 (26.64)	6.7	0.84	14.7														
	E43HXEC-LXX-XX-00		•	2667 (18.84)	9.4	0.42	3.7														
	<hr/>																				
	SIGMAX® E43 Series 3 rotor stacks	E43HXHB-LXX-XX-00	•		3958 (27.95)	12.5	0.24					4.8	106 (0.75)	0.9	0.2400 (1.694)	25.7 (11.66)					
		E43HXL B-LXX-XX-00	•		3958 (27.95)	6.2	0.96					19.3									
		E43HXEB-LXX-XX-00		•	2799 (19.77)	8.8	0.48					4.8									
		<hr/>																			
		E43HXHT-LXX-XX-00	•		3931 (27.76)	7.9	0.60					11.8									
E43HXL T-LXX-XX-00		•		3931 (27.76)	4.0	2.38	47.0														
E43HXET-LXX-XX-00			•	2780 (19.63)	5.6	1.19	11.8														
<hr/>																					
E43HXHA-LXX-XX-00		•		3905 (27.58)	5.0	1.48	28.6														
E43HXL A-LXX-XX-00	•		3905 (27.58)	2.5	5.9	114															
E43HXEA-LXX-XX-00		•	2761 (19.50)	3.5	2.95	28.6															
<hr/>																					
Torque range: 1529-2651 oz-in. 10.80-18.72 Nm	H43HXHC-LXX-XX-00	•		2163 (15.27)	13.3	0.21	1.3	↑	↑	↑	↑										
	H43HXL C-LXX-XX-00	•		2163 (15.27)	6.7	0.84	5.4														
	H43HXEC-LXX-XX-00		•	1529 (10.80)	9.4	0.42	1.3														
	<hr/>																				
	STANDARD H43 Series 3 rotor stacks	H43HXHB-LXX-XX-00	•		2256 (15.93)	12.5	0.24					1.8	70 (0.49)	0.9	0.2400 (1.694)	25.7 (11.66)					
		H43HXL B-LXX-XX-00	•		2256 (15.93)	6.2	0.96					7.0									
		H43HXEB-LXX-XX-00		•	1595 (11.26)	8.8	0.48					1.8									
		<hr/>																			
		H43HXHT-LXX-XX-00	•		2651 (18.72)	7.9	0.60					16.8									
H43HXL T-LXX-XX-00		•		2651 (18.72)	4.0	2.38	67.1														
H43HXET-LXX-XX-00			•	1874 (13.24)	5.6	1.19	16.8														
<hr/>																					
H43HXHA-LXX-XX-00		•		2336 (16.50)	5.0	1.48	40.8														
H43HXL A-LXX-XX-00	•		2336 (16.50)	2.5	5.9	163															
H43HXEA-LXX-XX-00		•	1864 (13.16)	3.5	2.95	40.8															

All ratings typical and at 25°C unless otherwise noted.

- Δ An "X" in the Model Number Code indicates an undefined option. Colored letter indicates winding. See How to Order and Model Number Code on page 68.
- Δ Motor connections are determined by the Windings/Leads designation in the Model Number Code on page 68. Note that the F designation, although not shown in the above tables, is an 8-lead option...see Terminations, page 76. In addition to the lead wire termination, terminal board and MS connector hookup for parallel, series or unipolar operation is also available.

- Δ With rated current applied. Windings at 130°C and motor unmounted and in still air at 40°C (without heat sink).
- Δ Windings at 130°C and motor in still air at 40°C (without heat sink). Operation of these motors above rated current may cause demagnetization. Contact factory.
- Δ Small signal inductance as measured with impedance bridge at 1kHz, 1 amp.
- Δ Thermal resistance measured with motor hanging in still air (unmounted).

DIMENSIONS . . . GENERAL PURPOSE—CONVENTIONAL HYBRIDS

$\frac{\text{in.}}{\text{mm}}$ (metric dimensions for ref. only)

NEMA 42 FRAME

(See page 76 for Technical Data)

SPLASHPROOF CONSTRUCTION/TERMINAL BOARD CONNECTIONS=L or M

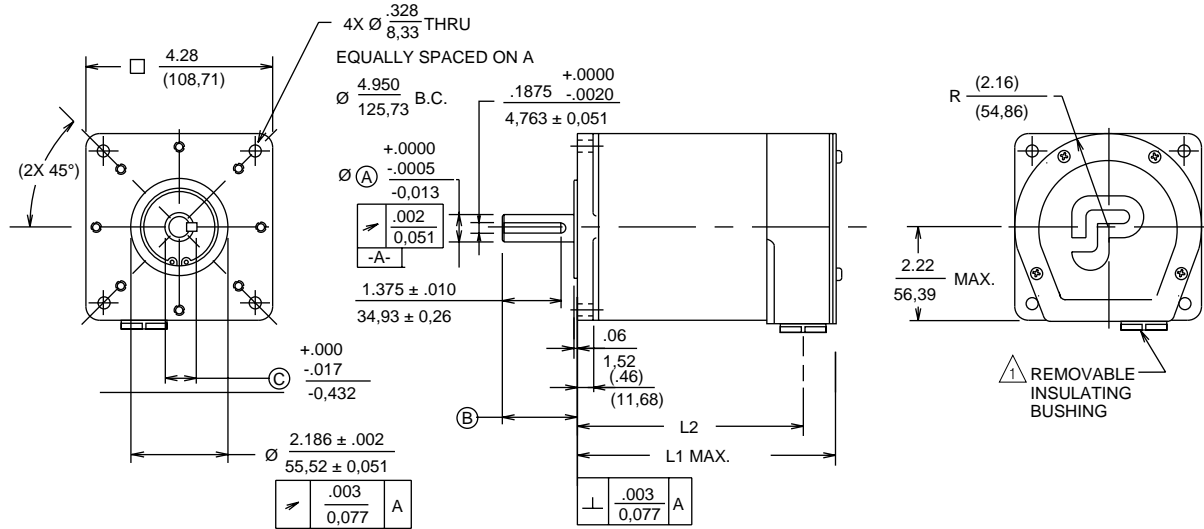

SYSTEM CONSTRUCTION/MS CONNECTOR=C and ENCODER OPTION

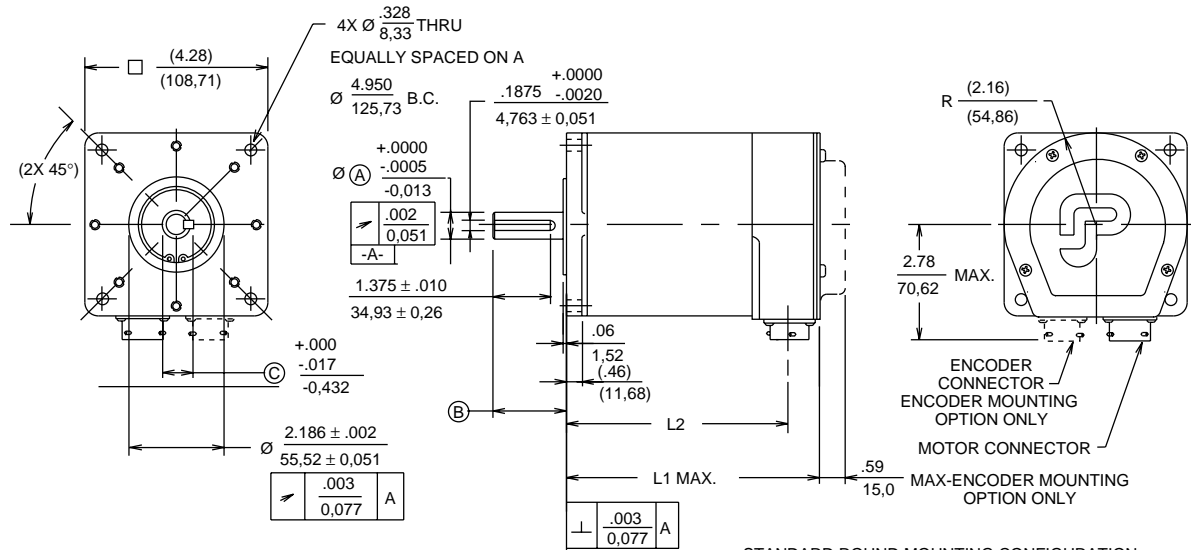

STANDARD ROUND MOUNTING CONFIGURATION
NOTE: NOT AVAILABLE ON 3 STACK MOTOR

MODEL NUMBER	L1 MAX.	L2	A	B	C
41H(C, L, OR M)	$\frac{5.61}{142,5}$	$\frac{(4.85)}{(123,19)}$	$\frac{.6250}{15,875}$	$\frac{1.75}{44,45}$	$\frac{.705}{17,91}$
42H(C, L, OR M)	$\frac{8.04}{204,22}$	$\frac{(7.29)}{(185,17)}$	$\frac{.6250}{15,875}$	$\frac{2.19}{55,63}$	$\frac{.705}{17,91}$
43H(C, L, OR M)	$\frac{10.56}{268,23}$	$\frac{(9.81)}{(249,18)}$	$\frac{.7500}{19,05}$	$\frac{2.19}{55,63}$	$\frac{.830}{21,09}$

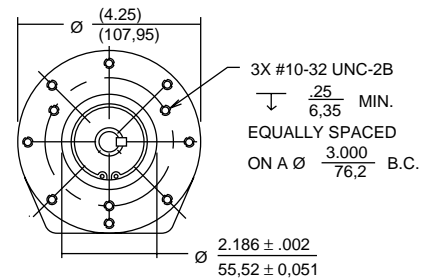

ROUND MOUNTING CONFIGURATION = R

NOTE:

△ L Construction = Conduit Connection (1/2 NPSC TAP) with .56 I.D. removable insulating bushing

M Construction = Conduit Connection (PG 13,5 TAP) (No insulating bushing supplied)

SPECIAL PURPOSE HYBRIDS



Our special purpose hybrid step motors include low inertia rotor hybrids for your special applications. The following pages provide technical and application data to simplify your selection process. Features and benefits, ratings and characteristics are provided for NEMA 23 frame sizes.

Feature

Two Year Warranty

Wide Range of Industry Standard and Special Winding Configurations

Sigma^{max}® Flux Focusing Technology

Extensive Selection of Shaft, End Bell, Termination, Encoder, and Splashproof Options

Optional Low Inertia Rotor - NEMA 23 Frame Only

Benefit

High quality, dependable operation

Match motor performance to your application

Flux focusing increases torque

An array of options to meet your needs

Produces the highest acceleration rate

SPECIAL GENERAL PURPOSE—CONVENTIONAL HYBRIDS NEMA 23 FRAME (2.3" Dia.)

MODEL NUMBER CODE

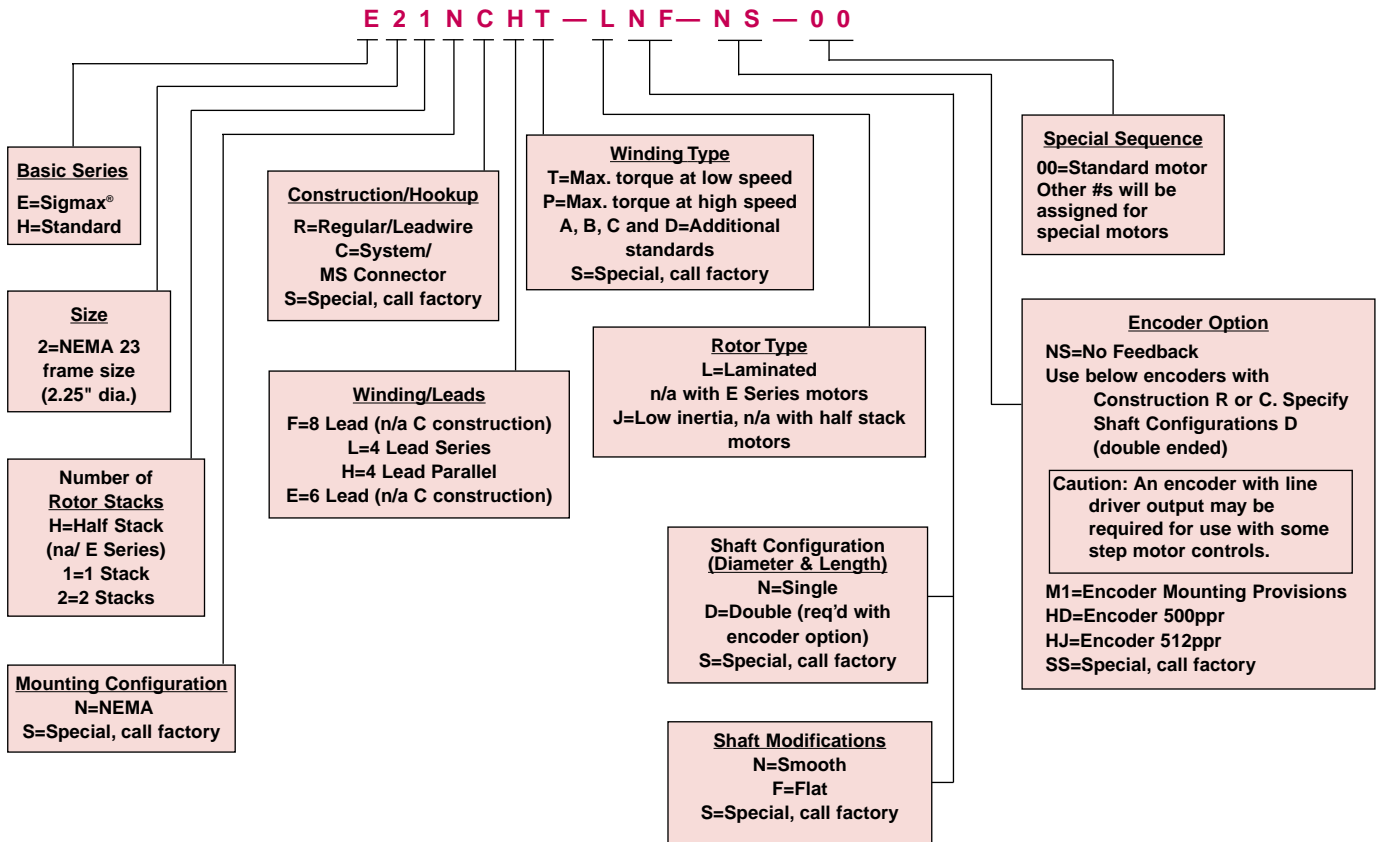

The example above indicates an E series (Sigma^{max}®) NEMA 23 frame motor with one rotor stack. This motor is equipped with an MS connector on the end of a 12 inch cable for power, a bipolar parallel connection, a maximum torque winding and a single ended shaft with a flat.

HOW TO ORDER

Review the Motor Model Number code to assure that all options are designated. Connections, encoders and phasing diagrams start on page 76. Motor dimensions are on page 60.

SPECIAL PURPOSE CONVENTIONAL HYBRIDS WITH LOW INERTIA ROTORS E “J” AND H “J” Series



NEMA 23 FRAME SIZE

- Unique hollow rotor construction
- Rapid start/stop and acceleration characteristics
- Very high torque to inertia
- Winding configurations for unipolar and bipolar drivers
- Industry standard mounting

These H and E Series motors employ special hollow, low mass rotors to achieve the industry's highest torque to inertia ratios.

Use low inertia motors for applications requiring exceptionally rapid start/stop, point to point positioning, and acceleration capabilities.

This high acceleration capability makes the low inertia motors most effective for operation below 2,000 RPM. See the ratings and characteristics on the following pages to determine whether your application can benefit from low inertia step motors.

Both standard hybrid and Sigmax® technology motors are offered to meet a broad range of performance requirements.

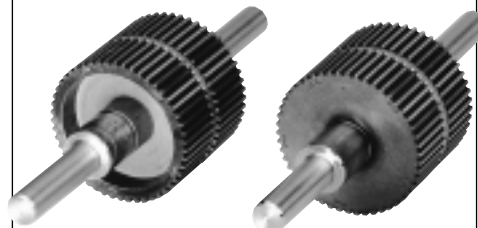

Low inertia rotor

Standard rotor

ROTOR INERTIA CHARACTERISTICS

Single and double stack motors are available with both standard and low inertia rotors. Choose low inertia to produce the highest acceleration rates possible. Choose standard to generate maximum torque.

SPECIAL PURPOSE—CONVENTIONAL HYBRIDS WITH LOW INERTIA ROTORS

NEMA 23 FRAME (2.3" Dia.)—Ratings and Characteristics

Review the Model Number Code, page 73, to assure that all options are designated. Connections, encoders and phasing diagrams start on page 76. Motor dimensions are on page 60. In addition to those below, motors with characteristics for specific performance requirements are offered. Contact factory for more details.

Motor Model Number [△]	Connection [△]			Holding Torque [△] (2 phases on) oz-in (Nm) ±10%	Rated Current/Phase [△] (amps DC)	Phase Resistance (ohms) ±10%	Phase Inductance [△] (mH) Typical	Detent Torque oz-in (Nm)	Thermal Resistance [△] (°C/watt)	Rotor Inertia oz-in-S ² (kgm ² x 10 ⁻³)	Weight lbs (kg)
	Parallel	Series	Unipolar								
Torque range: 77-108 oz-in. .54-.77 Nm											
E21NXHT-JXX-XX-00	•			108 (0.77)	2.8	0.72	2.2				
SIGMAX[®] E21NXLT-JXX-XX-00		•		108 (0.77)	1.39	2.8	9.0	4.5		0.0012	1.1
E21 Series E21NXET-JXX-XX-00			•	77 (0.54)	1.97	1.42	2.2	(0.032)	6.0	(0.008)	(0.50)
1 rotor stack											
Torque range: 54-77 oz-in. .38-.54 Nm											
H21NXHT-JXX-XX-00	•			77 (0.54)	2.8	0.72	2.1				
STANDARD H21NXLT-JXX-XX-00		•		77 (0.54)	1.39	2.8	8.4	1.8		0.0012	1.1
H21Series H21NXET-JXX-XX-00			•	54 (0.38)	1.97	1.42	2.1	(0.019)	6	(0.008)	(0.50)
1 rotor stack											
Torque range: 139-196 oz-in. .98-1.39 Nm											
E22NXHT-JXX-XX-00	•			196 (1.39)	5.0	0.33	1.2				
SIGMAX[®] E22NXLT-JXX-XX-00		•		196 (1.39)	2.5	1.2	4.6	9.2		0.0023	2.0
E22 Series E22NXET-JXX-XX-00			•	139 (0.98)	3.5	0.62	1.2	(0.065)	4.4	(0.016)	(0.91)
2 rotor stacks											
Torque range: 99-141 oz-in. .70-.99 Nm											
H22NXHT-JXX-XX-00	•			141 (0.99)	5.0	0.33	1.3				
STANDARD H22NXLT-JXX-XX-00		•		141 (0.99)	2.5	1.2	5.0	4.4		0.0023	2.0
H22 Series H22NXET-JXX-XX-00			•	99 (0.70)	3.5	0.62	1.3	(0.031)	4.4	(0.016)	(0.91)
2 rotor stacks											

All ratings typical and at 25°C unless otherwise noted.

- [△] An "X" in the Model Number Code indicates an undefined option. Colored letter indicates winding. See How to Order and Model Number Code on page 73.
- [△] Motor connections are determined by the Windings/Leads designation in the Model Number Code on Page 73. Note that the F designation, although not shown in the above tables, is an 8-lead option...see Terminations, page 76. In addition to the lead wire termination, terminal board and MS connector hookup for parallel, series or unipolar operation is also available.

- [△] With rated current applied. Windings at 130°C and motor unmounted and in still air at 40°C (without heat sink).
- [△] Windings at 130°C and motor in still air at 40°C (without heat sink). Operation of these motors above rated current may cause demagnetization. Contact factory.
- [△] Small signal inductance as measured with impedance bridge at 1kHz, 1 amp.
- [△] Thermal resistance measured with motor hanging in still air (unmounted).

CONVENTIONAL HYBRIDS TECHNICAL DATA

- Hybrid motor power connections
- Phase sequencing tables
- Synchronous motor power connections
- Encoder options

HYBRID MOTOR POWER CONNECTIONS

FLYING LEADS, TERMINAL BOARD OR MS CONNECTOR

Four winding designations; F, E, L or H may be specified in the Model Number Code. For all motor terminations, refer to the step motor controller connection diagram to assure that proper connections are made. Consult our application engineers for assistance if necessary.

DESIGNATION F . . . 8 flying leads, 8 terminals or MS connector

The 8 lead motor is the most versatile configuration. It may be connected by the user in choice of 8 lead, 4 lead (series or parallel) or 6 lead configuration.

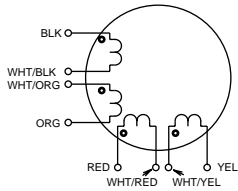

8-Lead Configuration

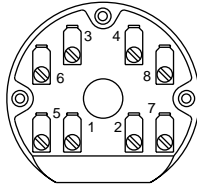

Terminal Board
NEMA 34 and 42

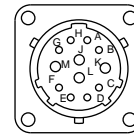

MS Connector
NEMA 34 and 42

CONNECTION	DRIVER CONNECTION	LEAD COLOR	TERMINAL #	MS PIN OUT
4-LEAD BIPOLAR	A	BLACK (BLK)	1	A
SERIES	\bar{A}	ORANGE (ORG)	3	B
	B	RED	2	C
	\bar{B}	YELLOW (YEL)	4	D
	NONE	WHT/BLK & WHT/ORG	6 & 5	E & F
	NONE	WHT/RED & WHT/YEL	8 & 7	G & H
4-LEAD BIPOLAR	A	BLK & WHT/ORG	1 & 5	A & F
PARALLEL	\bar{A}	ORG & WHT/BLK	3 & 6	B & E
	B	RED & WHT/YEL	2 & 7	C & H
	\bar{B}	YEL & WHT/RED	4 & 8	D & G
6-LEAD UNIPOLAR	A	BLACK (BLK)	1	A
	B	ORANGE (ORG)	3	B
	C	RED	2	C
	D	YELLOW (YEL)	4	D
	+V	WHT/BLK & WHT/ORG	6 & 5	E & F
	+V	WHT/RED & WHT/YEL	8 & 7	G & H
GROUND ³		GREEN/YELLOW		M

**MOTOR
POWER CONNECTOR**
MS3122E14-12P

SUGGESTED MATING CONNECTOR	
PAC SCI P.N.	MS P.N.
SZ00009	MS3116F14-12S

NOTE:

1. MS Pins J, K, L not used. Pin M is ground.
2. See phase sequencing tables, page 78.
3. Only the NEMA 23 flying lead motors DO NOT have the grn/yel ground wire.

DESIGNATION E . . . 6 flying leads, 6 terminals or MS connector

The 6 lead motor is normally used with unipolar drives. In some cases, the 6 lead motor can be used in a 4 lead series configuration for use with bipolar drives.

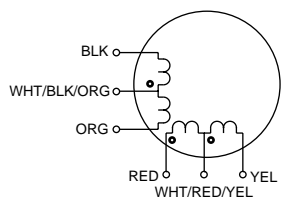

6-Lead Configuration

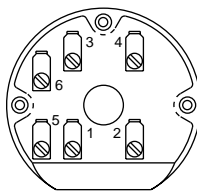

Terminal Board
NEMA 34 and 42

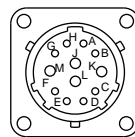

MS Connector
NEMA 34 and 42

CONNECTION	DRIVER CONNECTION	LEAD COLOR	TERMINAL #	MS PIN OUT
6-LEAD UNIPOLAR	A	BLACK (BLK)	1	A
	B	ORANGE (ORG)	3	B
	C	RED	2	C
	D	YELLOW (YEL)	4	D
	+V	WHT/BLK/ORG	5	J
	+V	WHT/RED/YEL	6	L
4-LEAD BIPOLAR SERIES	A	BLACK (BLK)	1	A
	\bar{A}	ORANGE (ORG)	3	B
	B	RED	2	C
	\bar{B}	YELLOW (YEL)	4	D
	NONE	WHT/BLK/ORG	5	J
	NONE	WHT/RED/YEL	6	L
GROUND		GREEN/YELLOW		M

MOTOR POWER CONNECTOR
MS3122E14-12P

SUGGESTED MATING CONNECTOR	
PAC SCI P.N. SZ00009	MS P.N. MS3116F14-12S

NOTE:

1. Terminals 7 and 8 are not used.
2. MS Pins E, F, G, H, K not used.
3. See phase sequencing tables, page 78.

DESIGNATION L or H . . . 4 flying leads, 4 terminals or MS connector

The 4 lead motor is for use with bipolar drives.

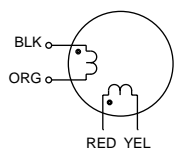

4-Lead Configuration

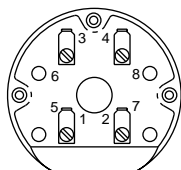

Terminal Board

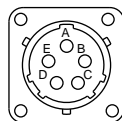

MS Connector
NEMA 34 and 42

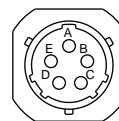

MS Connector
NEMA 23

CONNECTION	DRIVER CONNECTION	LEAD COLOR	TERMINAL #	MS PIN OUT
4-LEAD BIPOLAR	A	BLACK	1	A
	\bar{A}	ORANGE	3	B
	B	RED	2	C
	\bar{B}	YELLOW	4	D
GROUND		GREEN/YEL		E

MOTOR POWER CONNECTOR	
NEMA 34 & 42 MS3122E14-5P	NEMA 23 MS3121F14-5P

SUGGESTED MATING CONNECTOR NEMA 23, 34 & 42	
PAC SCI P.N. SZ00007	MS P.N. MS3116F14-5S

NOTE:

1. Terminals 5, 6, 7 and 8 are not used.
2. See phase sequencing tables, page 78.

PHASE SEQUENCING TABLES

NOTE: Direction of rotation as viewed from mounting end of motor.

DRIVER CONNECTION

STEP	A	\bar{A}	B	\bar{B}
1	+	-	0	0
2	+	-	+	-
3	0	0	+	-
4	-	+	+	-
5	-	+	0	0
6	-	+	-	+
7	0	0	-	+
8	+	-	-	+

BIPOLAR HALF STEP
PHASE SEQUENCING

DRIVER CONNECTION

STEP	A	\bar{A}	B	\bar{B}
1	+	-	-	+
2	-	+	-	+
3	-	+	+	-
4	+	-	+	-
1	+	-	-	+

BIPOLAR FULL STEP
PHASE SEQUENCING

NOTES:

1. 0 = OFF OR OPEN.
2. + = POSITIVE CURRENT FLOW.
3. - = NEGATIVE CURRENT FLOW.

STEP	A	B	C	D
1	GND	0	GND	0
2	0	GND	GND	0
3	0	GND	0	GND
4	GND	0	0	GND
1	GND	0	GND	0

UNIPOLAR FULL STEP
PHASE SEQUENCING

ENCODER OPTIONS

NEMA 23 ENCODER OPTION

The standard encoder offered on the NEMA 23 motor is the Agilent Technologies HEDS 5600 series.

NON-LINE DRIVER ENCODER

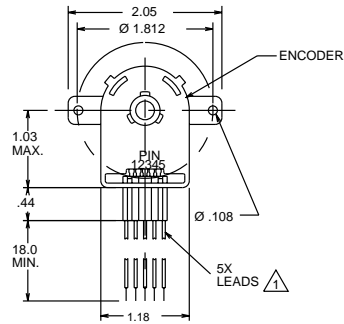

ENCODER OUTPUT
FOR CW DIRECTION OF ROTATION WHEN
VIEWED FROM MOTOR DRIVE SHAFT END.
(COMPLEMENTS NOT SHOWN) MIN. EDGE
SEPARATION 45°. INDEX GATED TO A AND B.

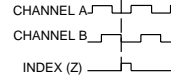

PIN	COLOR	FUNCTION
1	BLACK	GROUND
2	BLUE	Z
3	WHITE	A
4	RED	+5V
5	BROWN	B

PARAMETERS Δ

NON-LINE DRIVER

TYPE	INCREMENTAL	
	HD	HJ
ENCODER OPTION		
PULSES PER REVOLUTION	500	512
SUPPLY VOLTAGE	+5V \pm 10% @ 85 mA MAX.	
OUTPUT FORMAT	DUAL CHANNEL QUADRATURE AND INDEX	
OUTPUT TYPE	SQUARE WAVE TTL COMPATIBLE	
FREQUENCY RESPONSE:		
DATA	100 kHz	
INDEX	100 kHz	
ROTOR INERTIA	5×10^{-7} lb-in-S ²	
WEIGHT	0.08 lb.	

ENCODER MOUNTING PROVISION ONLY = M1

FOR AGILENT TECHNOLOGIES HEDS 5600 SERIES OR SIMILAR.

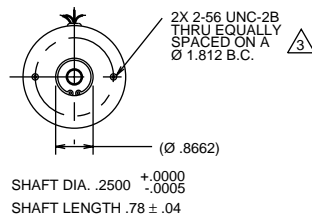

NOTES:

- Δ Leads are terminated with Agilent Technologies HEDS-8903 connector.
- Δ TYPICAL @ 25° C
- Δ Max. thread engagement of mounting screw not to exceed .200".

ENCODER OPTIONS (Con't.)

NEMA 34, NEMA 42 ENCODER OPTIONS

ENCODER MS CONNECTOR

ALL NEMA 34 AND NEMA 42 MOTORS WITH SYSTEM CONSTRUCTION MAY BE SPECIFIED WITH AN INTEGRAL OPTICAL ENCODER.

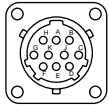

ENCODER CONNECTOR

PIN	FUNCTION
A	CHANNEL A
B	CHANNEL \bar{A}
C	CHANNEL B
D	CHANNEL \bar{B}
E	CHANNEL Z
F	CHANNEL \bar{Z}
G	+ 5 VDC
H	5 VDC RTN
K	N/C
J	N/C

MOTOR FEEDBACK CONNECTOR
MS3122E12-10P

SUGGESTED MATING CONNECTOR	
PAC SCI P.N.	MS P.N.
SZ00008	MS3116F12-10S

ENCODER MOUNTING PROVISION ONLY = M2

FOR AGILENT TECHNOLOGIES HED 5600 SERIES MODULAR ENCODER OR SIMILAR

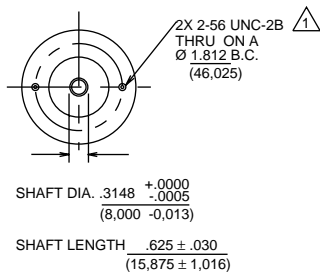

NOTES:

ENCODER MOUNTS TO MOTOR ENDBELL.

\triangle MAX. THREAD ENGAGEMENT OF MOUNTING SCREW NOT TO EXCEED .200".

SHAFT LOAD AND BEARING FATIGUE LIFE (L₁₀)

Bearings are the only wearing component of a step motor. PacSci uses heavy duty, long life bearings to assure you the maximum useful life from every step motor you purchase.

The N-mount is a standard NEMA front end bell for all NEMA 23 and many NEMA 34 frame size motors.

The H-mount is a heavy duty NEMA configuration, provided as standard on certain stack lengths in NEMA 34 and all NEMA 42 frame sizes. H-mount is an option on 3-stack NEMA 34 motors. Consult motor Model Number Codes for more information.

SHAFT LOADING

Motor	Max. Radial Force (Lb.) [△]	Max. Axial Force (Lb.)
2" N-Mount	19	65
3" N-Mount	35	180
3" H-Mount	96	180
4" H & R-Mount	140	400
Powermax II [△]	20	13

NOTES:

- [△] The max. radial forces shown reflect the following assumptions:
- Radial forces are slowly applied in a reversed manner.
 - Motors are operated at 1 * E-series torque.
 - Infinite fatigue life with 99% reliability.
 - Safety factor = 2.

- [△] These designs do not have a locked front bearing. They may be operated up to the maximum radial and axial loads and achieve an L-10 life of 10,000 hours at speeds up to 10,000 steps per second. Without a locked front bearing, loads in excess of those shown will overcome the bearing preload. Designs with a locked front bearing withstand much higher inward axial loads.

L-10 BEARING LIFE

2" N-MOUNT (round motor)

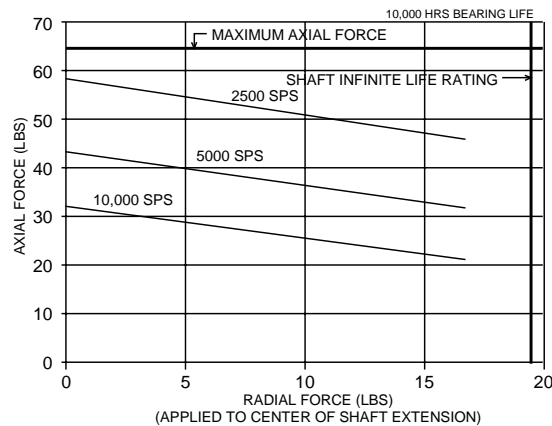

3" N-MOUNT

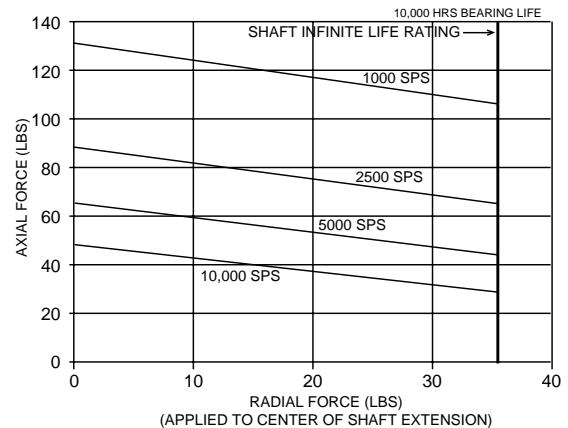

3" H-MOUNT

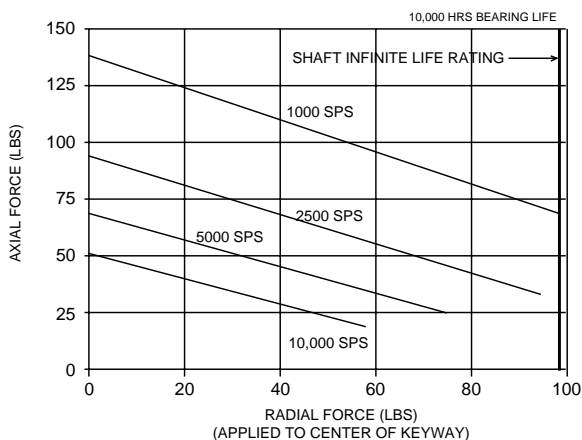

4" H & R-MOUNT

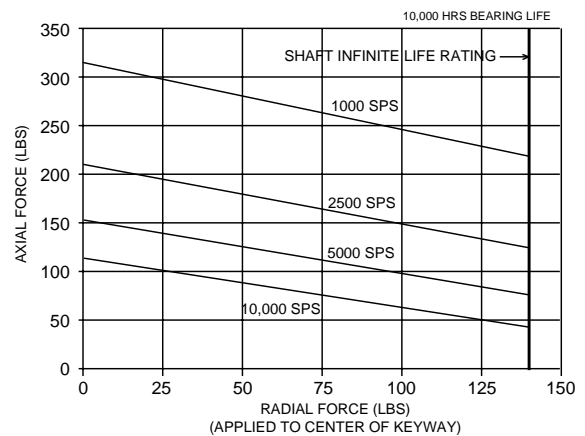



OBJY2

POWERSYNC SYNCHRONOUS MOTORS

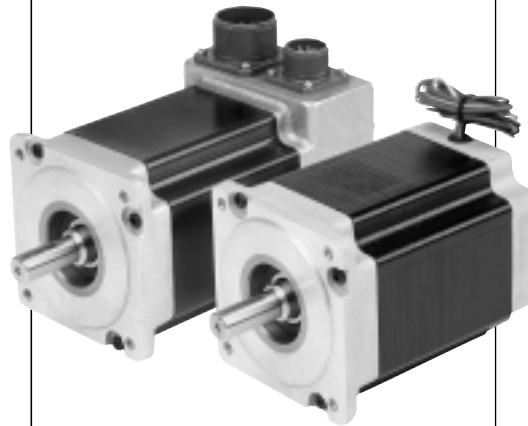

Pacific Scientific synchronous motors deliver bidirectional motion for low velocity, constant speed motor drives. These motors are driven economically from standard AC line voltage and the synchronous speed is related to the line frequency.

Synchronous motor components are identical to those in Pacific Scientific step motors except for high impedance, serially connected stator windings designed for direct operation from AC line voltage.

Synchronous motors are often used rather than geared AC induction motors. The desired speed is easily accomplished by gearing up or down from the synchronous speed using a gear box or simple timing belt and pulleys.

Agency Approval

All NEMA 34 and 42 Frame synchronous motors are UL recognized; Class B motor insulation (File 103510).

Typical Application

- Automatic antennas
- Carousel rotation
- Conveyor systems
- Dispensing machines
- Door openers
- Fluid metering
- Labeling machines
- Packaging machines
- Pumps; medical, process and fuel
- Sorting machines
- Test equipment
- Timing belt drives

FEATURES

With rated torques to 1500 oz-in. (93.75 lb-in.), 10,5 Nm, POWERSYNC provides the highest rated output torque range in the industry

Runs cooler than other AC synchronous motors

Rugged “housingless” square frame

Sealed per NEMA and IP65

Outer bearing races won't turn—front locked (in steel insert) and rear held by O-ring

Selection of terminations
Special shaft configurations available

Easy to apply

Precise speed control

72 RPM, 120V ac, 60 Hz

60 RPM, 120V ac, 50 Hz

Standard NEMA mounting

Motors (unloaded) reach synchronous speed in as little as 2 milliseconds. Ask us about response time at your load

BENEFITS

Optimized magnetics provide maximum performance in a small envelope, reducing space required for the motor. Exceptionally high torques provide unparalleled application freedom for AC synchronous motors

Longer, more reliable motor life—backed by a two year warranty

Efficient use of volume for optimal magnetic design

For splashproof requirements

Long life bearings—also prevents axial shaft movement for encoder applications

Match your requirements

Simple, economical control components (resistor and capacitor)

Synchronous speed for a broad range of applications

For North American use

For international requirements

Widely recognized standard

Fast response for on-off, precisely timed events

POWERSYNC™

NEMA 34 & 42 Frame (3.38" & 4.325" Square)

MODEL NUMBER CODE - NEMA 34 FRAME

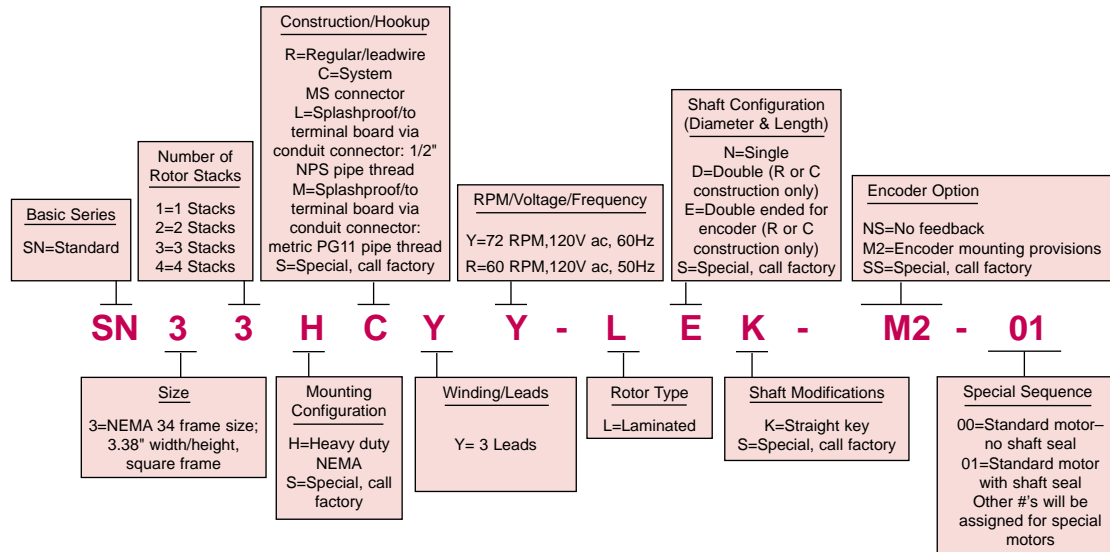

The example model number above indicates a standard NEMA 34 frame motor with a three stack rotor. This motor is equipped with a heavy-duty front end bell and shaft, and a sealed-system rear end bell with MS connectors. It operates at 72 RPM with 120V ac, 60 Hz input voltage. It has a three lead winding, a straight keyway, encoder mounting provisions and a shaft seal.

MODEL NUMBER CODE - NEMA 42 FRAME

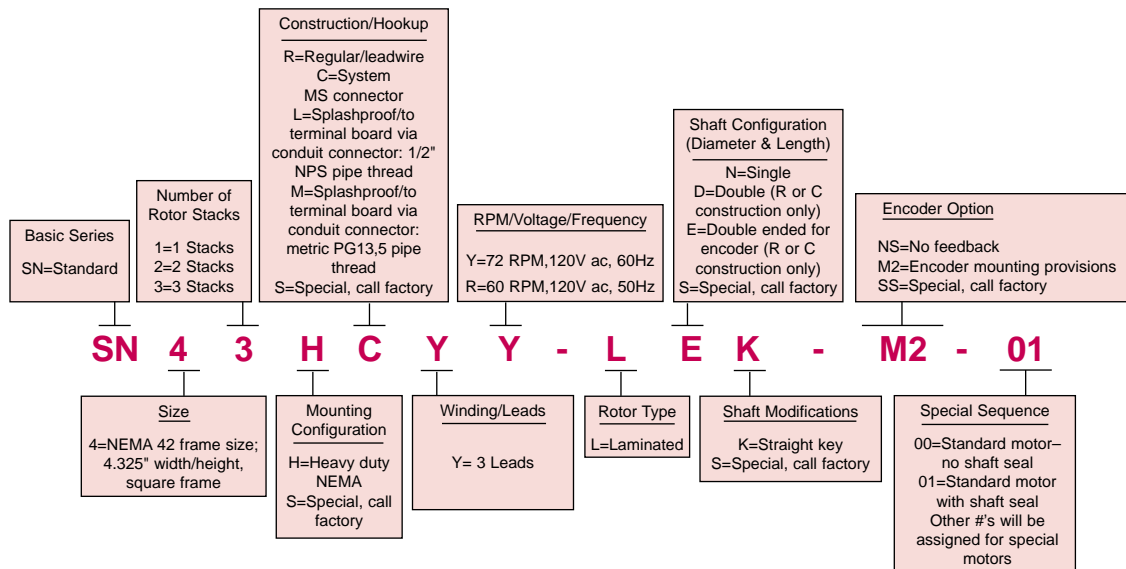

The example model number above indicates a standard NEMA 42 frame motor with a three stack rotor. This motor is equipped with a heavy-duty front end bell and shaft, and a sealed-system rear end bell with MS connectors. It operates at 72 RPM with 120V ac, 60 Hz input power. It has a three lead winding, a straight keyway, encoder mounting options and a shaft seal.

HOW TO ORDER

Review the Motor Model Number Code to assure that all options are designated. Call your nearest Pacific Scientific Motor Products Distributor to place orders and for application assistance. If you need to identify your Distributor, call the Motor Products Division at (815) 226-3100.

How to use this section

- If you're already familiar with AC synchronous motors and their application, refer to the appropriate Ratings and Characteristics tables in the Index and the available options. See the Model Number Code on page 83 to verify coded information prior to ordering.
- If you are not familiar with these motors, start with "Selection Overview" on page 85. The Motor Sizing & Selection section starting on page 95 will help you determine the key performance criteria in your application. You can then select the AC synchronous motor most appropriate for your needs.

Product Overview	82
How to use this Section	84
Features & Benefits	82
Selection Overview	85
NEMA 34 Frame Motors	
Model Number Code	83
Ratings and Characteristics	86-87
Typical Performance Curves	86-87
Dimensions	88-89
NEMA 42 Frame Motors	
Model Number Code	83
Ratings and Characteristics	86-87
Typical Performance Curves	86-87
Dimensions	90-91
Motor Technical Data	
Power Connections	92
Encoder Mounting Options	93
Bearing Fatigue Life (L ₁₀)	94
Motor Sizing & Selection	95-97
Other Sizing Considerations	98-100

POWERSYNC™

SELECTION OVERVIEW

POWERSYNC™

AC SYNCRHONOUS MOTORS

RPM	Voltage	Frequency	Rated torque oz-in. (Nm)	Rated inertia oz-in-s ² (kgm ² x 10 ⁻³)	Page
72	120V ac	60Hz	280-1500 (1,98 - 10,58)	.21-.92 (1,48 - 6,49)	86
60	120V ac	50Hz	375-1440 (2,64 - 10,17)	.29-1.3 (2,05 - 9,18)	87

For assistance in selecting a motor, see page 83.

POWERSYNC™

Ratings and Characteristics

72 RPM, 120 Vac, 60 Hz

Typical Performance Curve

also see p.97

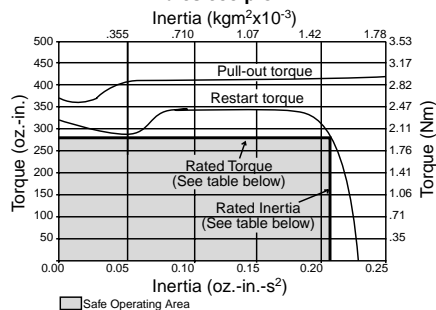

PULL-OUT Torque Curve The maximum friction load, at a particular inertial load, that can be applied to the shaft of an AC synchronous motor (running at constant speed) and not cause it to lose synchronism.

RESTART Torque Curve The maximum friction load, at a particular inertial load, that can be applied to the shaft of an AC synchronous motor without causing it to lose synchronism when accelerating to a constant speed from standstill.

For 72RPM, 120V ac, 60 Hz

NEMA Frame Size (in)	Model Number	Rated Torque oz-in (Nm)	Rated Inertia oz-in-s² (kgm²x10⁻³)	Max. Pull-out Torque oz-in (Nm)	RMS per Phase Current @ 80% Pull-out (Amps)	Detent Torque oz-in (Nm)	Thermal Res. (°C/watt)	Phase Res. (Ohms)	Phase Ind. (mH)	Rotor Inertia oz-in-s² (kgm²x10⁻³)	Weight lbs (kg)
34	SN31HXYY-LXK-XX-XX	280 (1,98)	0.21 (1,48)	410 (2,9)	0.38	18 (0,13)	2.7	86	601	0.0202 (0,14)	5 (2,27)
34	SN32HXYY-LXK-XX-XX	480 (3,39)	0.29 (2,05)	690 (4,87)	0.47	36 (0,25)	2	38	383	0.038 (0,27)	8.4 (3,81)
34	SN33HXYY-LXK-XX-XX	690 (4,87)	0.53 (3,74)	1015 (7,17)	0.78	54 (0,38)	1.6	32	362	0.0567 (0,4)	11.9 (5,39)
34	SN34HXYY-LXK-XX-XX	900 (6,36)	0.53 (3,74)	1520 (10,73)	1.43	57 (0,4)	1.3	16	191	0.075 (0,53)	15.1 (6,84)
42	SN41HXYY-LXK-XX-XX	715 (5,05)	0.4 (2,82)	1045 (7,38)	0.8	42 (0,3)	1.9	21	334	0.0783 (0,55)	11 (4,98)
42	SN42HXYY-LXK-XX-XX	1200 (8,47)	0.82 (5,79)	1580 (11,16)	1.19	84 (0,59)	1.3	9.5	198	0.1546 (1,09)	18.4 (8,34)
42	SN43HXYY-LXK-XX-XX	1500 (10,59)	0.92 (6,49)	2000 (14,12)	1.46	106 (0,75)	1	7.2	148	0.2293 (1,62)	25.7 (11,64)

△ An "X" in the Model Number Code indicates an undefined option. See page 83.

△ Rated Torque and Inertia are maximum values. The rated torque is the combination of load torque and friction torque. The motor will accelerate and run at synchronous speed, delivering the rated torque value while moving an inertia up to the rated inertia value. Rated inertia is a combination of the load inertia and the motor's rotor inertia. For assistance in motor selection, see page 95.

△ Rated Torque and Rated Inertia denote restart conditions with a stiff coupling of .3 arc sec/oz-in. minimum.

△ Detent torque is the maximum torque that can be applied to an unenergized step motor without causing continuous rotating motion.

△ Thermal resistance from motor winding to ambient with motor hanging in still air, unmounted.

△ Small signal inductance as measured with impedance bridge at 1kHz, 1 amp.

R-C PHASE SHIFT NETWORKS

A phase shift network is required and values have been selected to eliminate reversing torque and motor oscillations during motor startup. The network is placed in the circuit as shown in the diagram below. It is important to use the recommended values for the resistor and capacitor which vary with each motor, see p. 100. The resistors and capacitors are standard and are readily available from electronic component suppliers.

For 72RPM, 120V ac, 60 Hz

Model Number	Resistor		Capacitor	
	(Ohms)	(Watts)	(µf)	(rated Vac)
SN31HXYY-LXK-XX-XX	200	50	6	370
SN32HXYY-LXK-XX-XX	200	50	10	370
SN33HXYY-LXK-XX-XX	100	100	10	370
SN34HXYY-LXK-XX-XX	50	100	17.5	370
SN41HXYY-LXK-XX-XX	100	100	12.5	370
SN42HXYY-LXK-XX-XX	75	100	20	370
SN43HXYY-LXK-XX-XX	50	100	20	370

Schematic Diagram All Constructions

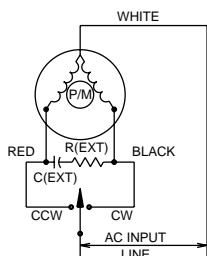

POWERSYNC™

Ratings and Characteristics

60 RPM, 120 Vac, 50 Hz

Typical Performance Curve

also see p.97

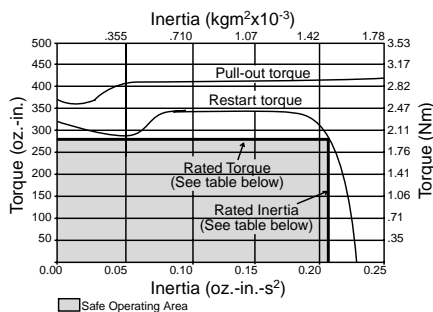

PULL-OUT Torque Curve The maximum friction load, at a particular inertial load, that can be applied to the shaft of an AC synchronous motor (running at constant speed) and not cause it to lose synchronism.

RESTART Torque Curve The maximum friction load, at a particular inertial load, that can be applied to the shaft of an AC synchronous motor without causing it to lose synchronism when accelerating to a constant speed from standstill.

For 60RPM, 120V ac, 50 Hz

NEMA Frame Size (in)	Model Number [△]	Rated Torque [△] oz-in [△] (Nm)	Rated Inertia [△] oz-in-s ² [△] (kgm ² x10 ⁻³)	Max. Pull-out Torque [△] oz-in [△] (Nm)	RMS per Phase Current @ 80% Pull-out (Amps)	Detent Torque [△] oz-in [△] (Nm)	Thermal Res. [△] (°C/watt)	Phase Res. (Ohms)	Phase Ind. (mH)	Rotor Inertia [△] oz-in-s ² [△] (kgm ² x10 ⁻³)	Weight lbs (kg)
34	SN31HXYR-LXK-XX-XX	375 (2,64)	0.29 (2,05)	490 (3,46)	0.34	18 (0,13)	2.7	136	990	0.0202 (0,14)	5 (2,27)
34	SN32HXYR-LXK-XX-XX	600 (4,24)	0.52 (3,67)	870 (6,14)	0.64	36 (0,25)	2	53	493	0.038 (0,27)	8.4 (3,81)
34	SN33HXYR-LXK-XX-XX	800 (5,65)	0.6 (4,23)	1120 (7,91)	0.67	54 (0,38)	1.6	35	417	0.0567 (0,4)	11.9 (5,39)
34	SN34HXYR-LXK-XX-XX	990 (6,99)	0.53 (3,74)	1565 (11,05)	1.1	57 (0,4)	1.3	18	226	0.075 (0,53)	15.1 (6,84)
42	SN41HXYR-LXK-XX-XX	700 (4,94)	0.53 (3,74)	1060 (7,49)	0.71	42 (0,3)	1.9	33	513	0.0783 (0,55)	11 (4,98)
42	SN42HXYR-LXK-XX-XX	1020 (7,22)	1.16 (8,19)	1575 (11,12)	0.93	84 (0,59)	1.3	15	300	0.1546 (1,09)	18.4 (8,34)
42	SN43HXYR-LXK-XX-XX	1440 (10,17)	1.3 (9,18)	2000 (14,12)	1.6	106 (0,75)	1	12	267	0.2293 (1,62)	25.7 (11,64)

[△] An "X" in the Model Number Code indicates an undefined option. See page 83.

[△] Rated Torque and Inertia are maximum values. The rated torque is the combination of load torque and friction torque. The motor will accelerate and run at synchronous speed, delivering the rated torque value while moving an inertia up to the rated inertia value. Rated inertia is a combination of the load inertia and the motor's rotor inertia. For assistance in motor selection, see page 95.

[△] Rated Torque and Rated Inertia denote restart conditions with a stiff coupling of .3 arc sec/oz-in. minimum.

[△] Detent torque is the maximum torque that can be applied to an unenergized step motor without causing continuous rotating motion.

[△] Thermal resistance from motor winding to ambient with motor hanging in still air, unmounted.

[△] Small signal inductance as measured with impedance bridge at 1kHz, 1 amp.

R-C PHASE SHIFT NETWORKS

A phase shift network is required and values have been selected to eliminate reversing torque and motor oscillations during motor startup. The network is placed in the circuit as shown in the diagram below. It is important to use the recommended values for the resistor and capacitor which vary with each motor, see p. 100. The resistors and capacitors are standard and are readily available from electronic component suppliers.

For 60RPM, 120V ac, 50 Hz

Model Number	Resistor		Capacitor	
	(Ohms)	(Watts)	(µf)	(rated Vac)
SN31HXYR-LXK-XX-XX	150	25	2	2.75
SN32HXYR-LXK-XX-XX	100	50	4	4.75
SN33HXYR-LXK-XX-XX	100	50	4	4.75
SN34HXYR-LXK-XX-XX	75	100	6.5	7.38
SN41HXYR-LXK-XX-XX	100	50	4	4.75
SN42HXYR-LXK-XX-XX	100	100	6.5	7.38
SN43HXYR-LXK-XX-XX	50	225	10.5	11.38

Schematic Diagram All Constructions

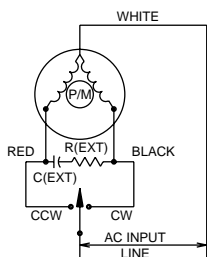

DIMENSIONS . . . POWERSYNC™

in. (metric dimensions for ref. only)
mm

NEMA 34 FRAME: All motors have a heavy duty NEMA front end bell and large diameter shaft to support the higher output torques

LEADWIRE HOOKUP - ENCODER OPTIONS

Model Number Code designation R (Construction/Hookup), p.83

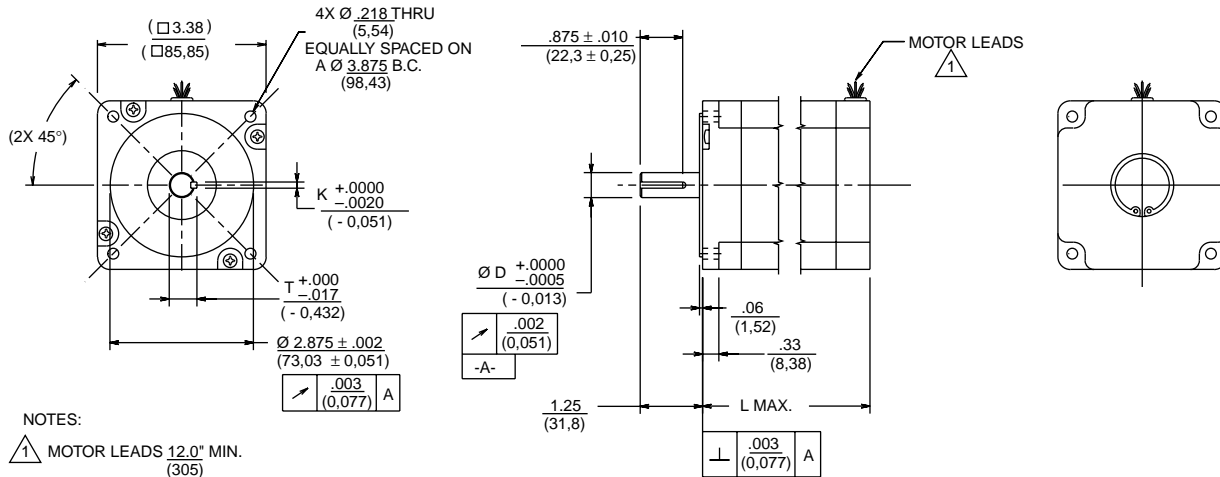

MOTOR*	D	K	T	L MAX.
31HR	.5000 (12,70)	.1250 (3,175)	.555 (14,09)	3.13 (79,5)
32HR	.5000 (12,70)	.1250 (3,175)	.555 (14,09)	4.65 (118,1)
33HR	.6250 (15,875)	.1875 (4,763)	.705 (17,91)	6.17 (156,7)
34HR	.6250 (15,875)	.1875 (4,763)	.705 (17,91)	7.68 (195,1)

*See Model Number Code, p 83.

LEADWIRE HOOKUP DOUBLE SHAFT CONFIGURATION

Model Number Code designation D (Shaft Configuration), p. 83

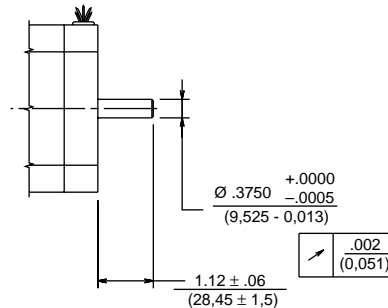

LEADWIRE HOOKUP ENCODER MOUNTING PROVISION

Model Number Code designation M2 (Encoder Mounting Option), p.83

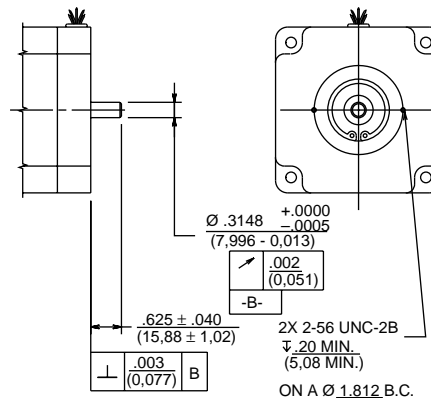

DIMENSIONS . . . POWERSYNC™

in. (metric dimensions for ref. only)
mm

NEMA 34 FRAME: All motors have a heavy duty NEMA front end bell and large diameter shaft to support the higher output torques

SPLASHPROOF CONSTRUCTION/TERMINAL BOARD CONNECTIONS

(via English or Metric thread for conduit) Model Number Code designation L or M (Construction/Hookup), p 83

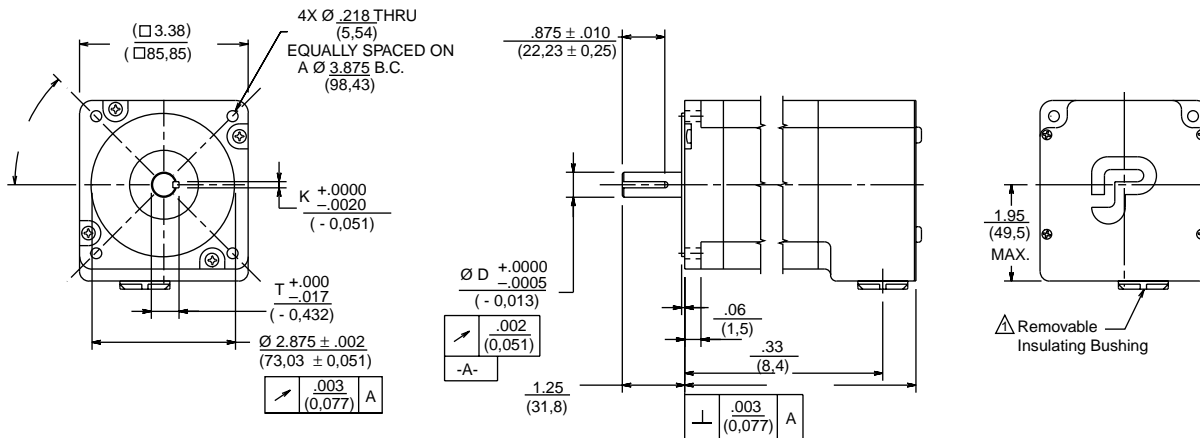

MOTOR*	D	K	T	X	L MAX.
31HR	.5000 (12,70)	.1250 (3,175)	.555 (14,09)	3.70 (93,9)	4.44 (112,8)
32HR	.5000 (12,70)	.1250 (3,175)	.555 (14,09)	5.22 (132,6)	5.96 (151,4)
33HR	.6250 (15,875)	.1875 (4,763)	.705 (17,91)	6.74 (171,20)	7.48 (189,9)
34HR	.6250 (15,875)	.1875 (4,763)	.705 (17,91)	8.25 (209,6)	8.99 (228,4)

*See Model Number Code, p 83.

SPLASHPROOF CONSTRUCTION/MS CONNECTOR(S)— ENCODER OPTION

Model Number Code designation C/System (Construction/Hookup) and Encoder Mounting Option, p 83

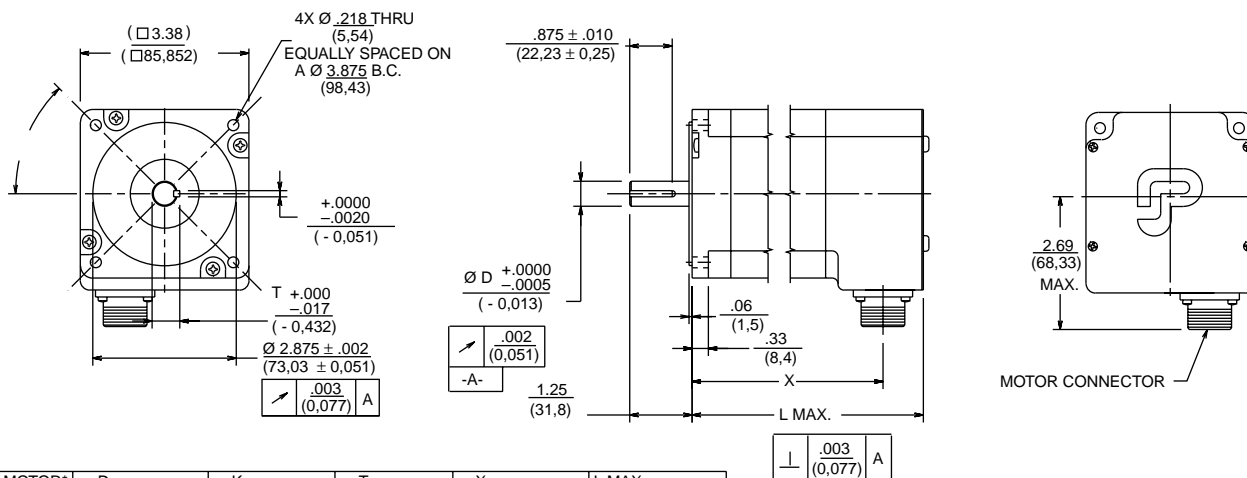

MOTOR*	D	K	T	X	L MAX.
31HR	.5000 (12,70)	.1250 (3,175)	.555 (14,09)	3.56 (90,42)	4.44 (112,8)
32HR	.5000 (12,70)	.1250 (3,175)	.555 (14,09)	5.07 (128,78)	5.96 (151,4)
33HR	.6250 (15,875)	.1875 (4,763)	.705 (17,91)	6.59 (167,39)	7.48 (189,9)
34HR	.6250 (15,875)	.1875 (4,763)	.705 (17,91)	8.11 (205,99)	8.99 (228,4)

*See Model Number Code, p 83.

ENCODER MOUNTING OPTION

NOTES:

- △ L Construction = Conduit connection (1/2 NPSC TAP) with $\frac{56}{14,2}$ I.D. removable insulating bushing
- M Construction = Conduit connection (PG 11 TAP). (No insulating bushing supplied)

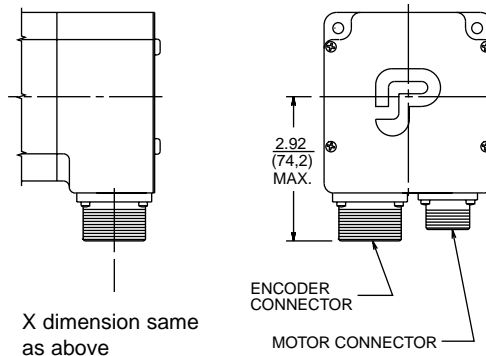

DIMENSIONS . . . POWERSYNC™

in. (metric dimensions for ref. only)
mm

NEMA 42 FRAME: All motors have a heavy duty NEMA front end bell and large diameter shaft to support the higher output torques

LEADWIRE HOOKUP

Model Number Code designation R (Construction/Hookup), p. 83

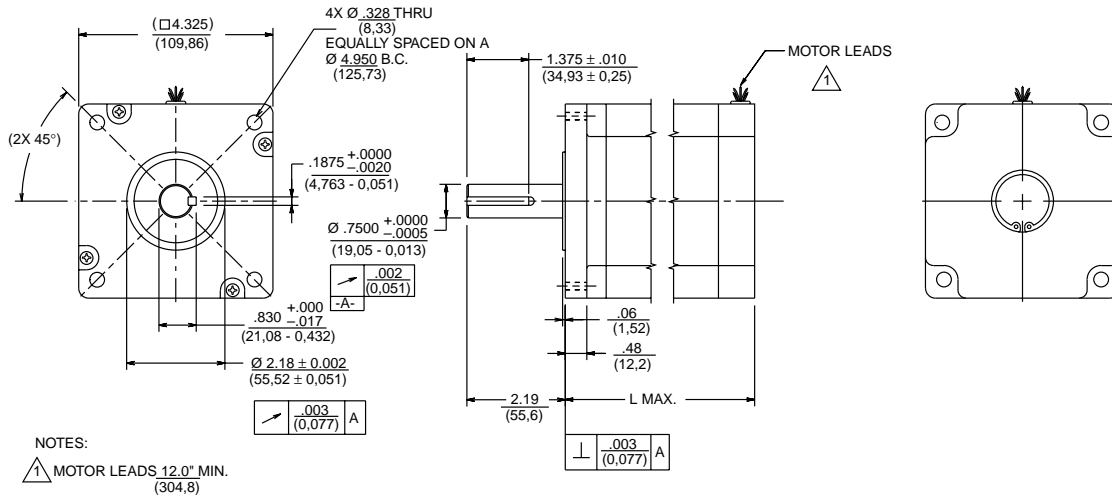

MOTOR*	L MAX.
41HR	3.89 (98,8)
42HR	5.91 (150,1)
43HR	7.92 (201,2)

* See Model Number Code, p.83

LEADWIRE HOOKUP DOUBLE SHAFT CONFIGURATION

Model Number Code designation D (Shaft Configuration), p. 83
Available on R construction only.

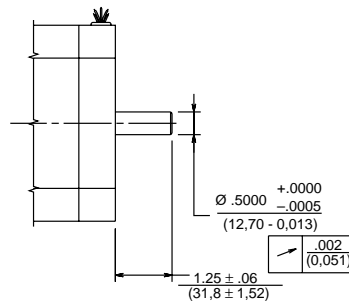

LEADWIRE HOOKUP ENCODER MOUNTING PROVISION

Model Number Code designation M2 (Encoder Mounting Option), p.83

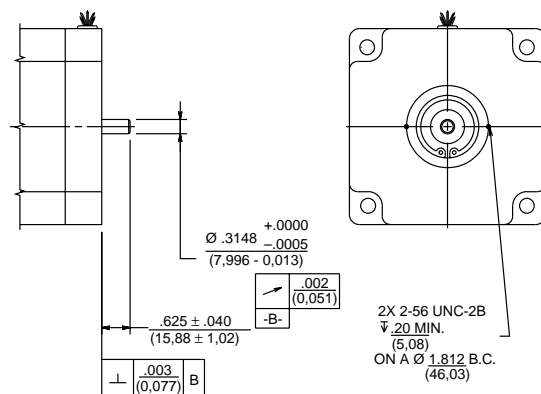

DIMENSIONS . . . POWERSYNC™

in. (metric dimensions for ref. only)
mm

NEMA 42 FRAME: All motors have a heavy duty NEMA front end bell and large diameter shaft to support the higher output torques

SPLASHPROOF CONSTRUCTION/TERMINAL BOARD CONNECTIONS

(via English or Metric thread for conduit) Model Number Code designation L or M (Construction/Hookup), p. 83.

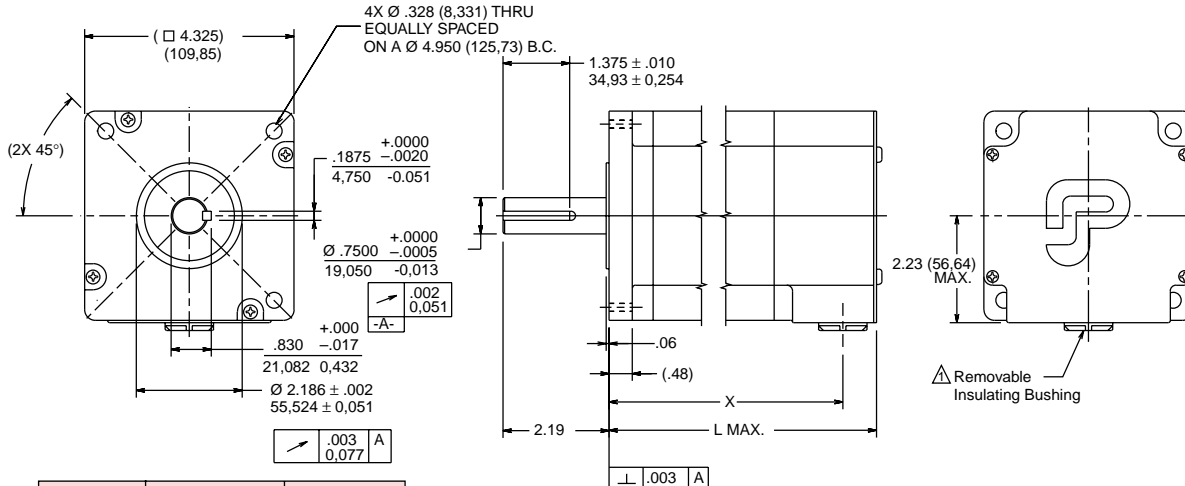

MOTOR*	X	L MAX.
41HR	4.46 (113,3)	3.89 (98,9)
42HR	6.48 (164,6)	5.91 (150,1)
43HR	8.49 (215,7)	7.92 (201,2)

* See Model Number Code, p.83

SPLASHPROOF CONSTRUCTION/MS CONNECTOR(S)— ENCODER OPTION

Model Number Code designation C/System (Construction/Hookup) and Encoder Mounting Option, p. 83.

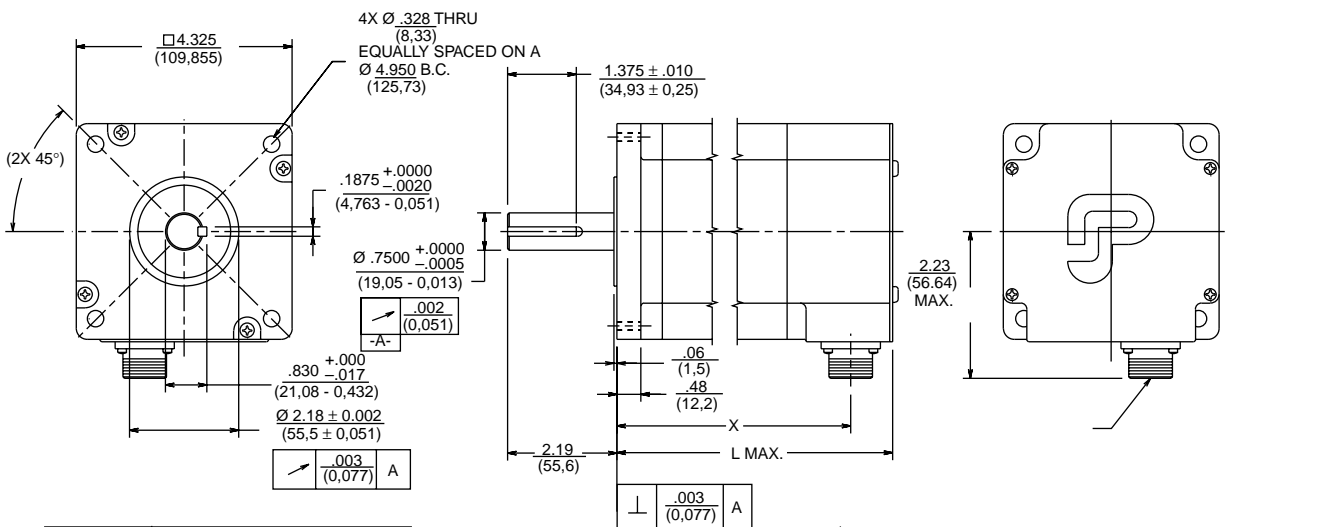

MOTOR*	X	L MAX.
41HR	4.32 (109,7)	5.20 (132,1)
42HR	6.33 (160,8)	7.22 (183,4)
43HR	8.35 (212,1)	9.23 (234,4)

* See Model Number Code, p.83

NOTES:

△ L Construction = Conduit connection (1/2 NPSC TAP) with $\frac{56}{14,2}$ I.D. removable insulating bushing

M Construction = Conduit connection (PG 13, 5 TAP). (No insulating bushing supplied)

ENCODER MOUNTING OPTION

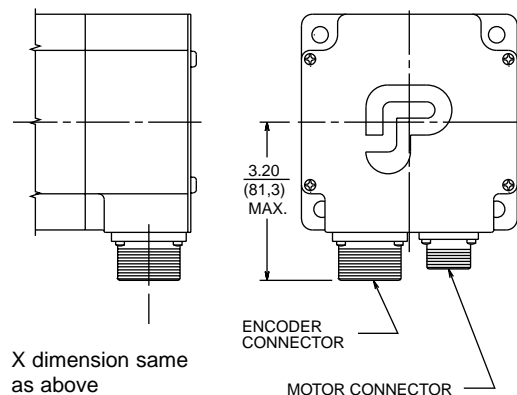

MOTOR POWER CONNECTIONS

- Connection options: Flying Leads, MS Connectors, Terminal Board

For all motor terminations refer to the following AC synchronous motor connection diagram to assure that proper connections are made. Consult our application engineers for assistance if necessary.

FLYING LEADS

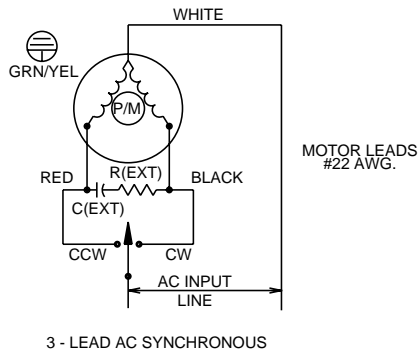

MS CONNECTOR

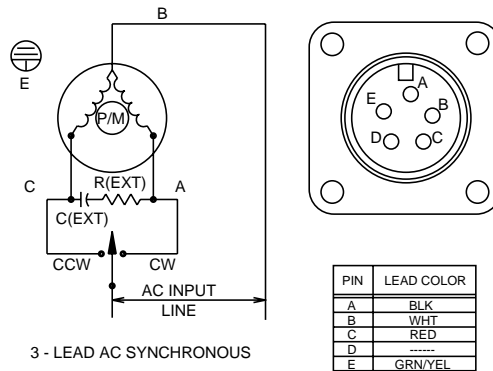

TERMINAL BOARD

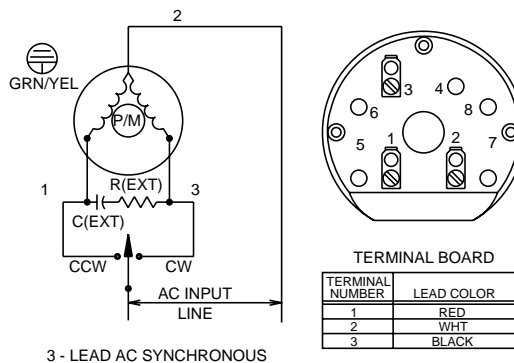

ENCODER OPTIONS...**POWERSYNC™**

NEMA 34 AND NEMA 42 ENCODER MOUNTING OPTIONS

Encoder factory installed (inside).
See NEMA 34 drawing, p. 89 and
NEMA 42 drawing, p. 91.

Encoder factory installed (outside on rear
end bell). See NEMA 34 drawing, p. 88
and NEMA 42 drawing, p. 90.

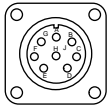

ENCODER CONNECTOR Δ

PIN	FUNCTION
A	CHANNEL A
B	CHANNEL \bar{A}
C	CHANNEL B
D	CHANNEL \bar{B}
E	CHANNEL Z
F	CHANNEL \bar{Z}
G	+ 5 VDC
H	5 VDC RTN

MOTOR FEEDBACK CONNECTOR
CA3102E20-7P-A206-F80-F0

SUGGESTED MATING CONNECTOR	
PAC SCI P.N.	CANNON P.N.
CZ00008	MS3106A20-7S-621

NOTE:

Δ NEMA 34, NEMA 42
SYSTEM CONSTRUCTION

SHAFT LOAD AND BEARING FATIGUE LIFE (L_{10})...POWERSYNC™

The **POWERSYNC** H-mount configuration has a heavy duty NEMA front end bell and a large diameter shaft to support the higher torque outputs.

Bearings are the only wearing component in an AC synchronous motor. PacSci uses heavy duty, long life bearings to assure you the maximum useful life from every AC synchronous motor you purchase.

SHAFT LOADING

The maximum radial fatigue load ratings reflect the following assumptions:

1. Motors are operated at 1× rated torque
2. Fully reversed radial load applied in the center of the keyway extension
3. Infinite life with 99% reliability
4. Safety factory = 2

Motor	Max. Radial Force (Lb.)	Max. Axial Force (Lb.)
31, 32	65	305
33, 34	110	305
41	125	404
42, 43	110	404

BEARING FATIGUE LIFE (L_{10}) See Model Number Codes on page 4 for clarification. Note: SPS = Speed, Full Steps Per Second

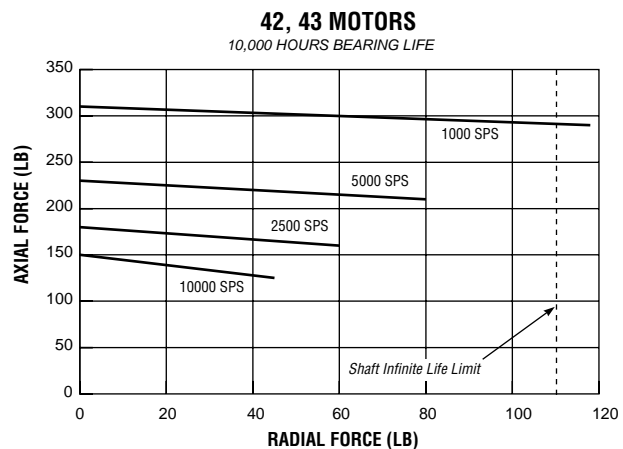
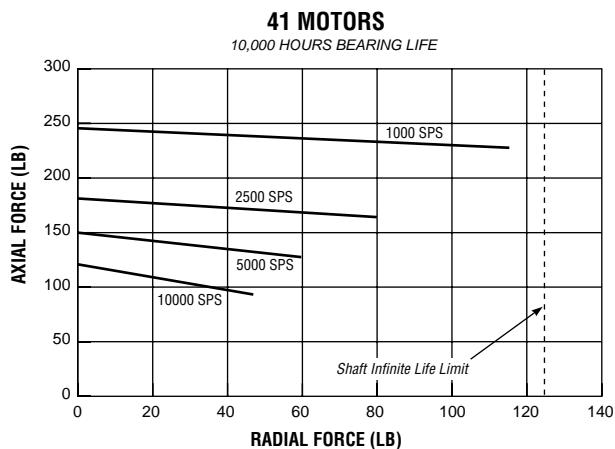
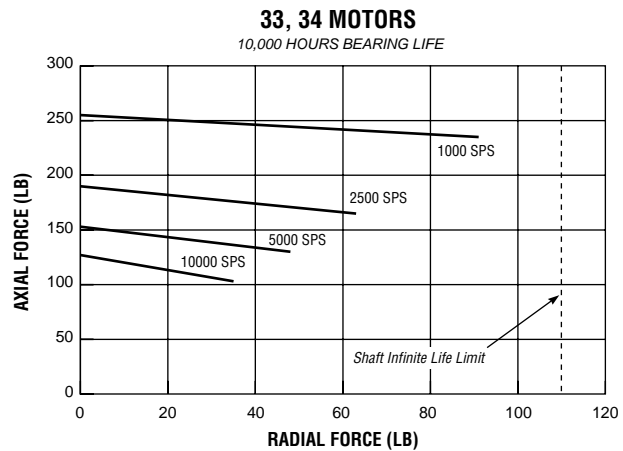
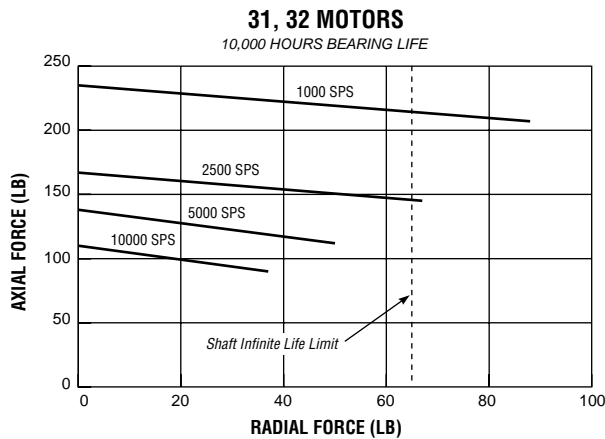

POWERSYNC™ MOTOR SIZING & SELECTION

Use this procedure to select a motor.

DETERMINE THE LOAD

Three load parameters, defined at the motor shaft, must be determined. If there is a mechanical linkage between the load and the motor shaft, e.g. gears or belts and pulleys, the effect of these mechanics must be taken into account. The three parameters are:

- Inertia, J (oz-in-s², kgm² x 10⁻³). Inertia is the resistance of an object to change in velocity, i.e., the resistance to accelerate or decelerate. Inertia can be calculated or measured. Inertia is an important parameter since it defines the torque required to accelerate the load.
- Friction Torque, T_F (oz-in, lb-in., or Nm). This is the torque required to overcome the contact between mechanical components that resists motion of these components relative to each other. Friction torque is independent of speed. It can be calculated but is usually measured using a torque wrench placed at the drive shaft point.
- Load Torque, T_L (oz-in, lb-in., or Nm). This is any torque required by the load and is separate from the friction torque.

MOTION CONTROL MECHANICS

Typical mechanical drive systems for motion control can be divided into four basic categories; direct drive, gear drive, leadscrew drive, and tangential drive. The following describes each one of the categories and provides the relevant formulas for calculating the various load parameters. In all instances, the formulas reflect all parameters back to the motor shaft. This means that all load parameters are transformed to the equivalent load parameters "seen" by the motor. Reflecting all parameters back to the motor shaft eases the calculations necessary to properly size the motor.

CALCULATING THE INERTIA OF A CYLINDER

Inertia can be seen as the resistance of an object to being accelerated or decelerated. In motion control applications, inertia is an important parameter since it is a major part in the definition of the torque required to accelerate and decelerate the load.

SOLID CYLINDER

The inertia of a solid cylinder can be calculated if either its weight and radius or its density, radius, and length are known. Lead screws, Rotary Tables and Solid Pulley's can be viewed as solid cylinders when performing this calculation.

$$\text{For known weight and radius: } J_L = \frac{1}{2} \frac{Wr^2}{g} = (0.0013)Wr^2$$

$$\text{For known density, radius, and length: } J_L = \frac{1}{2} \frac{\pi \rho r^4 l}{g} = (0.0041)l\rho r^4$$

- where: J_L = inertia (oz-in-s²)
 W = weight (oz)
 r = radius (in)
 l = length (in)
 ρ = density of material (oz/in³)
 g = gravitational constant (386 in/s²)

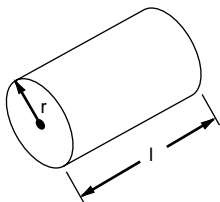

HOLLOW CYLINDER

The inertia of a hollow cylinder can be calculated if its weight, inside radius, and outside radius are known or if its density, inside radius, outside radius, and length are known.

The densities of some commonly used materials are given in the table below.

$$\begin{aligned} \text{For known weight and radii: } J_L &= \frac{1}{2} \frac{W}{g} (or^2 + ir^2) \\ &= (0.0013) (or^2 + ir^2)W \end{aligned}$$

$$\begin{aligned} \text{For known density, radii, and length: } J_L &= \frac{\pi l \rho}{2 g} (or^4 - ir^4) \\ &= (0.0041) (or^4 - ir^4)l\rho \end{aligned}$$

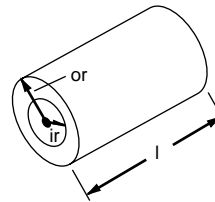

- where: J_L = inertia (oz-in-s²)
 W = weight (oz)
 or = outside radius (in)
 ir = inside radius (in)
 l = length (in)
 ρ = density of material (oz/in³)
 g = gravitational constant (386 in/s²)

MATERIAL DENSITIES

Material	oz/in ³
Aluminum	1.536
Brass	4.800
Bronze	4.720
Copper	5.125
Steel (cold rolled)	4.480
Plastic	0.640
Hard Wood	0.464
Soft Wood	0.288

DIRECT DRIVE LOAD

For direct drive loads, the load parameters do not have to be reflected back to the motor shaft since there are no mechanical linkages involved. The inertia of loads connected directly to the motor shaft can be calculated using the Solid and Hollow Cylinder examples.

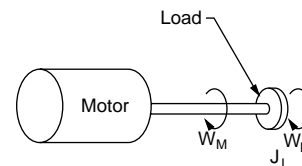

- Speed:** $W_M = W_L$
Torque: $T_L = T_M$
Inertia: $J_T = J_L + J_M$

- where: W_M = motor speed (rpm)
 W_L = load speed (rpm)
 J_T = total system inertia (oz-in-s²)
 J_L = load inertia (oz-in-s²)
 J_M = motor inertia (oz-in-s²)
 T_L = load torque at motor shaft (oz-in)
 T_T = load torque (oz-in)

MOTOR SIZING & SELECTION (CONT.)

GEAR DRIVEN LOAD

Load parameters in a gear driven system have to be reflected back to the motor shaft. The inertia of the gears have to be included in the calculations. The gear inertias can be calculated using the equations shown for the inertia of a Solid or Hollow Cylinder.

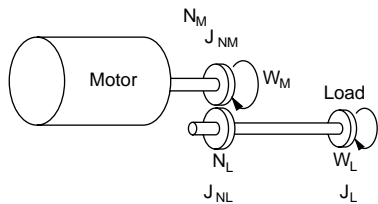

Speed: $W_M = W_L(N_L/N_M)$
Torque: $T_L = T'(N_M/N_L)$
Inertia: $J_T = (N_M/N_L)^2 (J_L + J_{NL}) + J_M + J_{NM}$

where: W_M = motor speed (rpm)
 W_L = load speed (rpm)
 N_M = number of motor gear teeth
 N_L = number of load gear teeth
 T_L = load torque reflected to motor shaft (oz-in)
 T' = load torque (oz-in)—not reflected
 J_T = total system inertia (oz-in-s²)
 J_L = load inertia (oz-in-s²)
 J_M = motor inertia (oz-in-s²)
 J_{NM} = motor gear inertia (oz-in-s²)
 J_{NL} = load gear inertia (oz-in-s²)

LEADSCREW DRIVEN LOAD

For this type of drive system, the load parameters have to be reflected back to the motor shaft. The inertia of the leadscrew has to be included and can be calculated using the equations for inertia of a solid cylinder. For precision positioning applications, the leadscrew is sometimes preloaded to eliminate or reduce backlash. If preloading is used, the preload torque must be included since it can be a significant term. The leadscrew's efficiency must also be considered in the calculations. The efficiencies of various types of leadscrews are shown here.

TYPICAL LEADSCREW EFFICIENCIES

Type	Efficiency
Ball-nut	0.90
Acme with plastic nut	0.65
Acme with metal nut	0.40

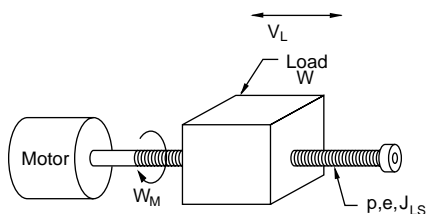

Speed: $W_M = V_L/p$
Torque: $T_L = \frac{1}{2\pi} \frac{F_L}{pe} + \frac{1}{2\pi} \frac{F_{PL}}{p} \times 0.2 \Delta$
 $= (0.159)F_L/pe + (0.032)F_{PL}/p$
Inertia: $J_T = \frac{W}{g} \left(\frac{1}{2\pi p} \right)^2 \frac{1}{e} + J_{LS} + J_M$
 $= (6.56 \times 10^{-5})W/ep^2 + J_{LS} + J_M$
Friction: $F_F = uW$
 $T_F = \frac{1}{2\pi} \frac{F_F}{pe} = (0.159)F_F/pe$

where: W_M = motor speed (rpm)
 V_L = linear load speed (in/min)
 p = lead screw pitch (revs/in)
 e = lead screw efficiency
 T_L = load torque reflected to motor shaft (oz-in)
 T_F = friction torque (oz-in)
 F_L = load force (oz)
 F_{PL} = preload force (oz)
 J_T = total system inertia (oz-in-s²)
 J_M = motor inertia (oz-in-s²)
 J_{LS} = lead screw inertia (oz-in-s²)
 W = load weight (oz)
 F_F = frictional force (oz)
 u = coefficient of friction
 g = gravitational constant (386 in/s²)

COEFFICIENTS OF FRICTION

Steel on steel	0.580
Steel on steel (lubricated)	0.150
Teflon on steel	0.040
Ball bushing	0.003

For certain applications, the frictional drag torque due to preloading should also be considered as part of the total torque requirement. Since optimum preloading is one-third of operating load, it is common practice to use 0.2 as the preload torque coefficient for the ball screw to obtain a maximum figure for preload frictional drag torque. At higher than optimum preloading, the preload frictional drag will add to the torque requirements, since it is a constant.

TANGENTIALLY DRIVEN LOAD

For this type of drive system, the load parameters have to be reflected back to the motor shaft. A tangential drive can be a rack and pinion, timing belt and pulley, or chain and sprocket. The inertia of the pulleys, sprockets, or pinion gears must be included in the calculations. These inertia's can be calculated using the equations shown for the inertia of a Solid or Hollow Cylinder.

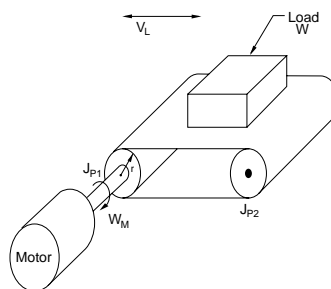

Speed: $W_M = \frac{1}{2\pi} \frac{V_L}{r} = (0.159)V_L/r$
Torque: $T_L = F_L r$
Inertia: $J_T = \frac{W}{g} r^2 + J_{P1} + J_{P2} + J_M$
 $= (0.0026)W r^2 + J_{P1} + J_{P2} + J_M$
Friction: $T_F = F_F r$

where: W_M = motor speed (rpm)
 V_L = linear load speed (in/min)
 r = pulley radius (in)
 T_L = load torque reflected to motor shaft (oz-in)
 T_F = friction torque (oz-in)
 F_L = load force (oz)
 J_T = total system inertia (oz-in-s²)
 J_M = motor inertia (oz-in-s²)
 J_P = pulley inertia(s) (oz-in-s²)
 W = load weight including belt (oz)
 F_F = frictional force (oz)
 g = gravitational constant (386 in/s²)

POWERSYNC™ MOTOR SIZING & SELECTION

After the load characteristics (torque and inertia) are determined, the motor can be selected. See the ratings and characteristics tables beginning on page 86 for reference. The data in the Rated Torque and Rated Inertia columns reflect the motors ability to stay in synchronism under external load conditions not exceeding these values. In the Typical Performance Curve below, the same Rated Torque and Rated Inertia values define the motors safe operating area. Once the load characteristics have been determined, proceed as follows:

- Find the ratings and characteristics table that reflects the desired motor on the basis of your synchronous speed (72 or 60 RPM), Voltage (120V ac) and frequency (60 or 50 Hz). For assistance, see the Selection Overview on page 85.
- In the ratings and characteristics table, find the motor with the Rated Torque and Rated Inertia combination that are slightly above the required torque and inertia load characteristics. This assures that the load characteristics are within the motors safe operating area.

TYPICAL PERFORMANCE CURVE △

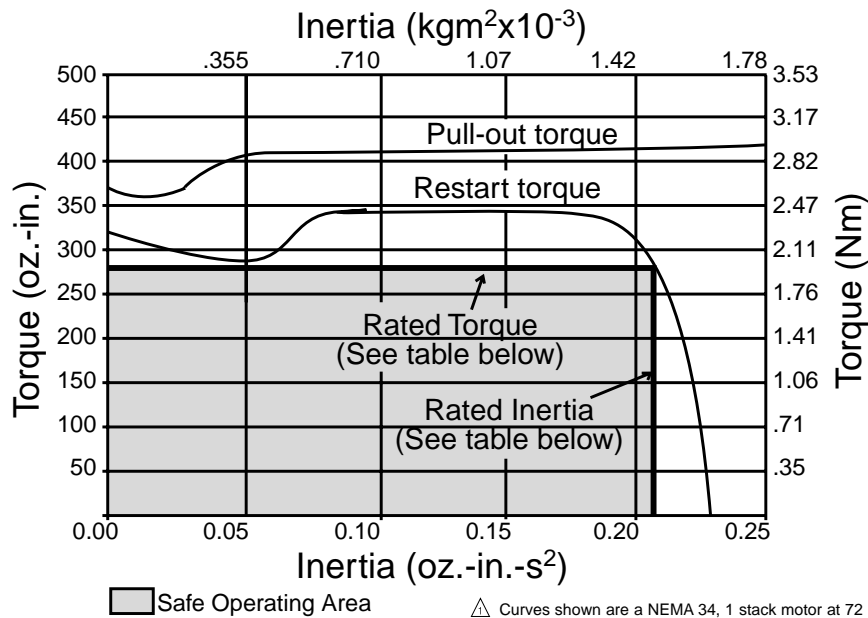

This typical performance curve shows the Pull-out torque, Restart (pull-in) torque, Rated torque and Rated Inertia. These terms are defined as follows.

- Pull-out torque. The maximum friction load, at a particular inertial load, that can be applied to the shaft of an AC synchronous motor (running at constant speed) and not cause it to lose synchronism.
- Restart (Pull-in) torque. The maximum friction load, at a particular inertial load, that can be applied to the shaft of an AC synchronous motor without causing it to lose synchronism when accelerating to a constant speed from standstill.
- Rated torque. The maximum frictional torque that the motor can accelerate from standstill to synchronous speed.
- Rated inertia. The maximum inertial load the motor can accelerate from standstill to synchronous speed.

OTHER SELECTION CONSIDERATIONS... POWERSYNC™

It is worthwhile to review these points to determine if they apply to your particular application.

Temperature The insulation class for POWERSYNC motors is NEMA class B (maximum of 130°C inside the motor). This rating is established by hanging the motor in still air, locking the rotor and energizing the windings. The recommended maximum room temperature is 40°C. If the motor is subjected to 40°C room temperature, the motor housing temperature could reach 100°C.

Vibration With all Synchronous Motors, there is some vibration that exists while the motor is running. This becomes less noticeable when the motor is loaded and flexible couplings or belts are used to connect the load. Vibration insulators can also be used between the motor and the mounting bracket.

Starting A low speed AC synchronous motor is an appropriate solution to a variety of demanding applications including those which require six or more starts per minute. The motor has no significant current rise on starting and hence no additional heat rise with repeated starts. The motors will start within 1.5 cycles of the applied frequency and will reach synchronous speed within 2 to 25 milliseconds at 60 Hz.

The extremely high torque and small frame size of the POWERSYNC motors often lends the motor as a suitable substitute for gearmotors. The advantages include concentric shaft and omission of gear backlash. Additionally, starting times of gearmotors will be slightly greater due to gearing backlash.

Two or more POWERSYNC motors may be operated simultaneously from the same power source, if the total current required by the motors does not exceed the current capacity of the supply. However, since the at rest position of the motors is indeterminant, mechanical synchronization of two or more motors may never be achieved because of the starting time differential that may exist between motors.

Stalling Low speed motors will not overheat if stalled because starting, full load and no load currents are essentially the same. However, prolonged operation against a solid stop will eventually cause bearing fatigue and probable failure. Stall torque cannot be measured in the conventional manner because there is no average torque delivered when the rotor is not in synchronization with the apparent rotation of the stator magnetic field.

Residual Torque When power is removed from the motor, there is some residual torque present. This is called the motor's detent torque and is shown in the catalog ratings table. This torque should not be used for holding a load in situations requiring safety. This parameter is inherent to the motor design and may vary as much as 50%.

Holding Torque When using an AC synchronous motor on any system with a "potential" type loading, like gravity, it may be desirable to have the motor hold in a position while waiting to rotate. This can be done by using a DC power supply attached to one or both motor phases. The figure on page 99 shows a typical connection diagram.

R-C PHASE SHIFT NETWORK...POWERSYNC™

R-C Network- Resistor and capacitor networks are specific to each motor offering. Reference the data contained in the data table for values and specifications. Deviations from recommended capacitor or resistor values can reduce forward torque and permit the motor to exhibit some of its forward torque in the reverse mode (vibration). This scenario is less of a problem if the load is substantially frictional. Other values can be recommended by the factory for specific applications. Capacitor and resistor values have been selected to provide the highest possible torque without sacrificing smooth operation throughout the safe operating area. Capacitor and resistor values may be adjusted by the factory to accommodate specific application needs. The figure below shows the connection diagram for AC synchronous motors.

TYPICAL OPERATION

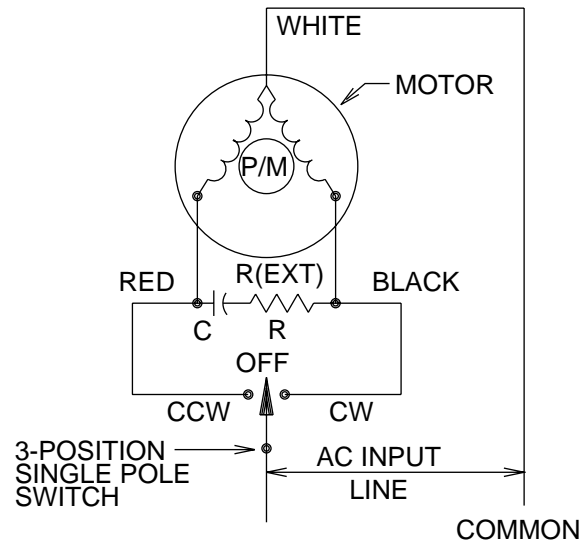

CONVERSION TABLES

ROTARY INERTIA CONVERSION TABLE

(To convert from A to B, multiply by entry in table)

B A	gm-cm ²	oz-in ²	gm-cm-s ²	Kg-cm ²	lb-in ²	oz-in-s ²	lb-ft ²	Kg-cm-s ²	lb-in-s ²	lb-ft-s ² or slug-ft ²
gm-cm ²	1	5.46 x 10 ⁻³	1.01 x 10 ⁻³	10 ⁻³	3.417 x 10 ⁻⁴	1.41 x 10 ⁻⁵	2.37 x 10 ⁻⁶	1.01 x 10 ⁻⁶	8.85 x 10 ⁻⁷	7.37 x 10 ⁻⁸
oz-in ²	182.9	1	.186	.182	.0625	2.59 x 10 ⁻³	4.34 x 10 ⁻⁴	1.86 x 10 ⁻⁴	1.61 x 10 ⁻⁴	1.34 x 10 ⁻⁵
gm-cm-s ²	980.6	5.36	1	.9806	.335	1.38 x 10 ⁻²	2.32 x 10 ⁻³	10 ⁻³	8.67 x 10 ⁻⁴	7.23 x 10 ⁻⁵
Kg-cm ²	1000	5.46	1.019	1	.3417	1.41 x 10 ⁻²	2.37 x 10 ⁻³	1.019 x 10 ⁻³	8.85 x 10 ⁻⁴	7.37 x 10 ⁻⁵
lb-in ²	2.92 x 10 ³	16	2.984	2.926	1	4.14 x 10 ⁻²	6.94 x 10 ⁻³	2.98 x 10 ⁻³	2.59 x 10 ⁻³	2.15 x 10 ⁻⁴
oz-in-s ²	7.06 x 10 ⁴	386.08	72.0	70.615	24.13	1	.1675	7.20 x 10 ⁻²	6.25 x 10 ⁻²	5.20 x 10 ⁻³
lb-ft ²	4.21 x 10 ⁵	2304	429.71	421.40	144	5.967	1	4.297	.3729	3.10 x 10 ⁻²
Kg-cm-s ²	9.8 x 10 ⁵	5.36 x 10 ³	1000	980.66	335.1	13.887	2.327	1	.8679	7.23 x 10 ⁻²
lb-in-s ²	1.129 x 10 ⁶	6.177 x 10 ³	1.152 x 10 ³	1.129 x 10 ³	386.08	16	2.681	1.152	1	8.33 x 10 ⁻²
lb-ft-s ² or slug-ft ²	1.355 x 10 ⁷	7.41 x 10 ⁴	1.38 x 10 ⁴	1.35 x 10 ⁴	4.63 x 10 ³	192	32.17	13.825	12	1

TORQUE CONVERSION TABLE

(To convert from A to B, multiply by entry in table)

B A	dyne-cm	gm-cm	oz-in	Kg-cm	lb-in.	N-m	lb-ft	Kg-m
dyne-cm	1	1.019 x 10 ⁻³	1.416 x 10 ⁻⁵	1.0197 x 10 ⁻⁶	8.850 x 10 ⁻⁷	10 ⁻⁷	7.375 x 10 ⁻⁸	1.019 x 10 ⁻⁸
gm-cm	980.665	1	1.388 x 10 ⁻²	10 ⁻³	8.679 x 10 ⁻⁴	9.806 x 10 ⁻⁵	7.233 x 10 ⁻⁵	10 ⁻⁵
oz-in.	7.061 x 10 ⁴	72.007	1	7.200 x 10 ⁻²	6.25 x 10 ⁻²	7.061 x 10 ⁻³	5.208 x 10 ⁻³	7.200 x 10 ⁻⁴
Kg-cm	9.806 x 10 ⁵	1000	13.877	1	.8679	9.806 x 10 ⁻²	7.233 x 10 ⁻²	10 ⁻²
lb-in	1.129 x 10 ⁶	1.152 x 10 ³	16	1.152	1	.112	8.333 x 10 ⁻²	1.152 x 10 ⁻²
N-m	10 ⁷	1.019 x 10 ⁴	141.612	10.197	8.850	1	.737	.101
lb-ft	1.355 x 10 ⁷	1.382 x 10 ⁴	192	13.825	12	1.355	1	.138
Kg-m	9.806 x 10 ⁷	10 ⁵	1.388 x 10 ³	100	86.796	9.806	7.233	1

CONVERSION FACTORS

TO OBTAIN	MULTIPLY NUMBER OF	BY
-----------	--------------------	----

LENGTH

cm	inches	2.540
cm	feet	30.48
inches	cm	.3937
inches	feet	12.0
feet	cm	3.281 x 10 ⁻²
feet	inches	8.333 x 10 ⁻²

MASS

gm	oz	28.35
gm	lb	453.6
gm	slug	1.459 x 10 ⁻⁴
oz	gm	3.527 x 10 ⁻²
oz	lb	16.
oz	slug	514.7
lb	gm	2.205 x 10 ³
lb	oz	6.250 x 10 ⁻²
lb	slug	32.17
slug*	gm	6.853 x 10 ⁻⁵
slug	oz	1.943 x 10 ⁻³
slug	lb	3.108 x 10 ⁻²

*1 slug mass goes at 1 ft/sec² when acted upon by 1 lb force.

POWER

H.P.	(oz-in.) (deg./sec)	1.653 x 10 ⁻⁷
H.P.	(oz-in.) (RPM)	9.917 x 10 ⁻⁷
H.P.	(#ft) (deg./sec)	3.173 x 10 ⁻⁵
H.P.	(#ft) (RPM)	1.904 x 10 ⁻³
H.P.	watts	1.341 x 10 ⁻³
Watts	(oz-in.) (deg./sec)	1.232 x 10 ⁻⁴
Watts	(oz-in.) (RPM)	7.395 x 10 ⁻⁴
Watts	(#ft) (deg./sec)	2.366 x 10 ⁻²
Watts	(#ft) (RPM)	.1420
Watts	H.P.	745.7

TORQUE TO INERTIA RATIO

rad/sec ²	oz-in./gm-cm ²	7.062 x 10 ⁴
rad/sec ²	oz-in./oz-in ²	386.1

TORQUE GRADIENT

#ft/rad	oz-in./degree	0.2984
dyne-cm/rad	oz-in./degree	4.046 x 10 ⁶

TO OBTAIN	MULTIPLY NUMBER OF	BY
-----------	--------------------	----

FORCE

dyne	gm*	980.7
dyne	oz	2.780 x 10 ⁴
dyne	lb	4.448 x 10 ⁵
gm*	dyne	1.020 x 10 ⁻³
oz	dyne	3.597 x 10 ⁻⁵
lb	dyne	2.248 x 10 ⁻⁶

* used as force units

ROTATION

degrees/sec.	RPM	6.
degrees/sec.	rad/sec.	57.30
RPM	degrees/sec.	.1667
RPM	rad/sec.	9.549
rad/sec.	degrees/sec.	1.745 x 10 ⁻²
rad/sec.	RPM	.1047

MECHANISM EFFICIENCIES

Acme-screw w/brass Nut	-0.35-0.65
Acme-screw w/plastic Nut	-0.50-0.85
Ball-screw	-0.85-0.95
Preloaded Ball screw	-0.75-0.85
Spur or Bevel gears	-0.90
Timing Belts	-0.96-0.98
Chain & Sprocket	-0.95-0.98
Worm gears	-0.45-0.85

MATERIAL DENSITIES

MATERIALS	lb/in ³	gm/cm ³
Aluminum	0.096	2.66
Brass	0.300	8.30
Bronze	0.295	8.17
Copper	0.322	8.91
Plastic	0.040	1.11
Steel	0.280	7.75
Hard Wood	0.029	0.80

FRICTION COEFFICIENTS F_{fr}=μW_L

MATERIALS	μ	MECHANISM	μ
Steel on Steel	-0.58	Ball Bushings	<0.001
Steel on Steel (greased)	-0.15	Linear Bearings	<0.001
Aluminum on Steel	-0.45	Dove-tail Slides	-0.2
Copper on Steel	-0.30	Gibb Ways	-0.5
Brass on Steel	-0.35		
Plastic on Steel	-0.15-0.25		

Acceleration

The change in velocity as a function of time. Acceleration usually refers to increasing velocity, and deceleration to decreasing velocity.

Accuracy

A measure of the difference between expected position and actual position of a motor or mechanical system. Motor accuracy is usually specified as an angle representing the maximum deviation from expected position.

Ambient temperature

The temperature of the cooling medium, usually air, immediately surrounding the motor or another device.

Angular accuracy

The measure of shaft positioning accuracy on a servo or stepping motor.

Bipolar chopper driver

A class of step motor driver which uses a switch mode (chopper) technique to control motor current and polarity. Bipolar indicates the capability of providing motor phase current of either polarity (+ or -).

Class B insulation

A NEMA insulation specification. Class B insulation is rated to an operating (internal) temperature of 130°C.

Class H insulation

A NEMA insulation specification. Class H insulation is rated to an operating (internal) temperature of 180°C.

Closed loop

A broadly applied term, relating to any system in which the output is measured and compared to the input. The output is then adjusted to reach the desired condition. In motion control, the term typically describes a system utilizing a velocity and/or position transducer to generate correction signals in relation to desired parameters.

Commutation

1. A term which refers to the action of steering currents or voltages to the proper motor phases so as to produce optimum motor torque. In brush type motors, commutation is done electromechanically via the brushes and commutator. In brushless motors, commutation is done by the switching electronics using rotor position information obtained by Hall sensors, a Tachsyn, or resolver.

2. Commutation of step motors is normally done open loop. Feedback from the motor is not required to hold rotor position precisely.

Controller

A term describing a functional block containing an amplifier, power supplies, and possibly position-control electronics for operating a servomotor or step motor.

Current, Rated

The maximum allowable continuous current a motor can handle without exceeding motor temperature limits.

Detent torque

The maximum torque that can be applied to an unenergized step motor without causing continuous rotating motion.

Driver

Electronics which convert step and direction inputs to high power currents and voltages to drive a step motor. The step motor driver is analogous to the servomotor amplifier's logic.

Duty cycle

For a repetitive cycle, the ratio of on time to total cycle time.
 Duty cycle (%) =

$$\frac{\text{On time}}{\text{On time} + \text{Off time}} * 100\%$$

Encoder

A feedback device which converts mechanical motion into electronic signals. The most commonly used, rotary encoders, output digital pulses corresponding to incremental angular motion. For example, a 1000 line encoder produces 1000 pulses every mechanical revolution. The encoder consists of a glass or metal wheel with alternating transparent and opaque stripes, detected by optical sensors to produce the digital outputs.

Feedback

A signal which is transferred from the output back to the input for use in a closed loop system.

Friction

A resistance to motion caused by contacting surface. Friction can be constant with varying speed (Coulomb friction) or proportional to speed (viscous friction).

Holding torque

Sometimes called static torque, holding torque specifies the maximum external torque that can be applied to a stopped,

energized motor without causing the rotor to rotate. Generally used as a figure of merit when comparing motors.

Hybrid step motor

A motor designed to move in discrete increments of steps. The motor has a permanent magnet rotor and a wound stator. Such motors are brushless. Phase currents are commutated as a function of time to produce motion.

Idle current reduction

A step motor driver feature that reduce the phase current to the motor when no motor motion is commanded (idle condition) for a specified period of time. Idle current reduction reduces motor heating and allows high machine throughputs from a given motor.

Indexer

Electronics which convert high level motion commands from a host computer, PLC or operator panel into step and direction pulse streams for use by the step motor driver. Indexers can be broadly divided into two classes. A preset indexer typically accepts distance, velocity and ramp time inputs only. The more sophisticated programmable indexer is capable of complex motion control and includes program memory.

Inductance (L) (Millihenries) (Line-to-line)

The electrical equivalent to mechanical inertia; that is, the property of a circuit, which when no current flows has a tendency to resist current flow, and when current is flowing has a tendency to maintain that current flow. Pacific Scientific measures inductance (line-to-line) with a bridge at 1000 Hz and with the rotor positioned so the back-EMF waveform is at the peak of the sinusoid.

Inductance (mutual)

Mutual inductance is the property that exists between two current carrying conductors or coils when magnetic lines of force from one link with those of the other.

Inertia

The property of an object to resist change in velocity unless acted upon by an outside force. Higher inertia objects require larger torques to accelerate and decelerate. Inertia is dependent upon the mass and shape of the object.

GLOSSARY

(CONT)

Inertial match

For most efficient operation, the system coupling ratio should be selected so that the reflected inertia of the load is equal to the rotor inertia of the motor.

Insulation Class

The rating assigned to the maximum temperature capability of the insulating components in a motor or other piece of equipment.

Microstepping

An electronic technique for increasing a step motor's position resolution and velocity smoothness by appropriately scaling the phase currents.

Microstepping is also a technique used to reduce or eliminate the effects of system resonance at low speeds.

Mid-range instability

A phenomenon in which a step motor can fall out of synchronism due to a loss of torque at mid-range speeds. The torque loss is due to the interaction of the motor's electrical characteristics and the driver's electronics. Some drivers have circuitry to eliminate or reduce the effects of mid-range instability.

NEMA

National Electrical Manufacturer's Association. Acronym for an organization which sets standards for motors and other industrial electrical equipment.

Open-loop

A system in which there is no feedback. Motor motion is expected to faithfully follow the input command. Stepping motor systems are an example of open-loop control.

Pull-out torque

The maximum friction load, at a particular inertial load, that can be applied to the shaft of a synchronous motor (running at constant speed) and not cause it to lose synchronism.

Pulse rate

The frequency of the step pulses applied to a step motor driver. The pulse rate, multiplied by the resolution of the motor/driver combination (in steps per revolution), yields the rotational speed in revolutions per second.

Repeatability

The degree to which a parameter such as position or velocity can be duplicated.

Resistance, RH Hot (Ohms) (Line-to-line)

The motor's terminal resistance value specified at the hot winding temperature, which is at the motor's maximum rated temperature.

Resolution

The smallest increment into which a parameter can be broken down. For example, a 1000 line encoder has a resolution of 1/1000 of a revolution.

Resonance

Oscillatory behavior caused by mechanical limitations.

Restart torque

The maximum friction load, at a particular inertial load, that can be applied to the shaft of a synchronous motor without causing it to lose synchronism when accelerating to a constant speed from standstill.

Settling time

The time required for a parameter to stop oscillating or ringing and reach its final value.

Speed

Describes the linear or rotational velocity of a motor or other object in motion.

Step angle

The angular distance the shaft rotates upon receipt of a single step command.

Synchronism

A motor rotating at a speed corresponding correctly to the applied step pulse frequency is said to be in synchronism. Load torques in excess of the motor's capacity (rated torque) will cause a loss of synchronism. This condition is not damaging to a step motor.

Thermal resistance (R_{th}) ($^{\circ}\text{C}/\text{watt}$)

An indication of how effectively a unit rids itself of heat; a measure of temperature rise per watts lost. On Pacific Scientific literature, it is the specified value from the motor windings to the ambient, under locked rotor conditions.

Thermal time constant (T_{th}) (minutes)

The time required for a motor to attain 63.2% of its final temperature for a fixed power input.

Torque

A measure of angular force which

produces rotational motion. This force is defined by a linear force multiplied by a radius e.g. lb-in. Torque is an important parameter of any motion control system.

Formula:

$$\text{Torque (lb-ins)} = 63,025 \times \text{HP/RPM}$$

Torque-to-inertia ratio

Defined as the motor's holding torque divided by the inertia of its rotor. The higher the ratio, the higher a motor's maximum acceleration capability will be.

Unipolar driver

A step motor driver configuration that uses a unipolar power supply and is capable of driving phase current in only one direction. The motor phase winding must be center tapped (6 or 8 lead) to operate with a unipolar driver. The center tap is used instead of providing the current reversal of a bipolar driver.

Velocity

The change in position as a function of time. Velocity has both a magnitude and sign.

WARRANTY AND LIMITATION OF LIABILITY

Includes software provided by Pacific Scientific

Pacific Scientific warrants its "Product(s)" to the original purchaser (the "Customer"), and in the case of original equipment manufacturers or distributors to their original consumer (the "Customer") to be free from defects in material and workmanship and to be made in accordance with Customer's specifications which have been accepted in writing by Pacific Scientific. In no event, however, shall Pacific Scientific be liable or have any responsibility under such warranty if the Products have been improperly stored, installed, used or maintained, or if Customer has permitted any unauthorized modifications, adjustments and/or repairs to such Products. Pacific Scientific's obligation is limited solely to repairing or replacing (at its option), at its approved repair facility, any Products or parts which prove to Pacific Scientific's satisfaction to be defective as a result of defective materials or workmanship, in accordance with Pacific Scientific's stated warranty, provided, however, that written notice of claimed defects shall have been given to Pacific Scientific within two (2) years after the date of the product date code that is affixed to the Product, and within thirty (30) days from the date any such defect is first discovered. The Product or parts claimed to be defective must be returned to Pacific Scientific, transportation prepaid by Customer, with written specifications of the claimed defect. Evidence acceptable to Pacific Scientific must be furnished that the claimed defects were not caused by misuse, abuse or neglect by anyone other than Pacific Scientific.

THE FOREGOING WARRANTIES ARE IN LIEU OF ALL OTHER WARRANTIES (EXCEPT AS TO TITLE), WHETHER EXPRESSED OR IMPLIED, INCLUDING WITHOUT LIMITATION, ANY WARRANTY OF MERCHANTABILITY OR OF FITNESS FOR ANY PARTICULAR PURPOSE, AND ARE IN LIEU OF ALL OTHER OBLIGATIONS OR LIABILITIES ON THE PART OF PACIFIC

SCIENTIFIC. PACIFIC SCIENTIFIC'S MAXIMUM LIABILITY WITH RESPECT TO THESE WARRANTIES, ARISING FROM ANY CAUSE WHATSOEVER, INCLUDING WITHOUT LIMITATION, BREACH OF CONTRACT, NEGLIGENCE, STRICT LIABILITY, TORT, WARRANTY, PATENT OR COPYRIGHT INFRINGEMENT, SHALL NOT EXCEED THE PRICE SPECIFIED FOR THE PRODUCTS OR PROGRAMS GIVING RISE TO THE CLAIM, AND IN NO EVENT SHALL PACIFIC SCIENTIFIC BE LIABLE UNDER THESE WARRANTIES OR OTHERWISE, EVEN IF PACIFIC SCIENTIFIC HAS BEEN ADVISED OF THE POSSIBILITY OF SUCH DAMAGES, FOR SPECIAL, INCIDENTAL OR CONSEQUENTIAL DAMAGES INCLUDING WITHOUT LIMITATION, DAMAGE OR LOSS RESULTING FROM INABILITY TO USE THE PRODUCTS OR PROGRAMS, INCREASED OPERATING COSTS RESULTING FROM A LOSS OF THE PRODUCTS OR PROGRAMS, LOSS OF ANTICIPATED PROFITS, OR OTHER SPECIAL, INCIDENTAL OR CONSEQUENTIAL DAMAGES, WHETHER SIMILAR OR DISSIMILAR, OF ANY NATURE ARISING OR RESULTING FROM THE PURCHASE, INSTALLATION, REMOVAL, REPAIR, OPERATION, USE OR BREAKDOWN OF THE PRODUCTS OR PROGRAMS, OR ANY OTHER CAUSE WHATSOEVER INCLUDING PACIFIC SCIENTIFIC'S NEGLIGENCE.

The foregoing shall also apply to Products or parts for the same which have been repaired or replaced pursuant to such warranty.

No person, including any agent, distributor, or representative of Pacific Scientific, is authorized to make any representation or warranty on behalf of Pacific Scientific concerning any Products manufactured by Pacific Scientific, except to refer purchasers to this warranty.

TECHNICAL
NOTES

4301 Kishwaukee Street
P.O. Box 106
Rockford, Illinois 61105-0106
(815) 226-3100 Fax (815) 226-3080

Locations:
Rockford, IL
Wilmington, MA
Juarez, Mexico

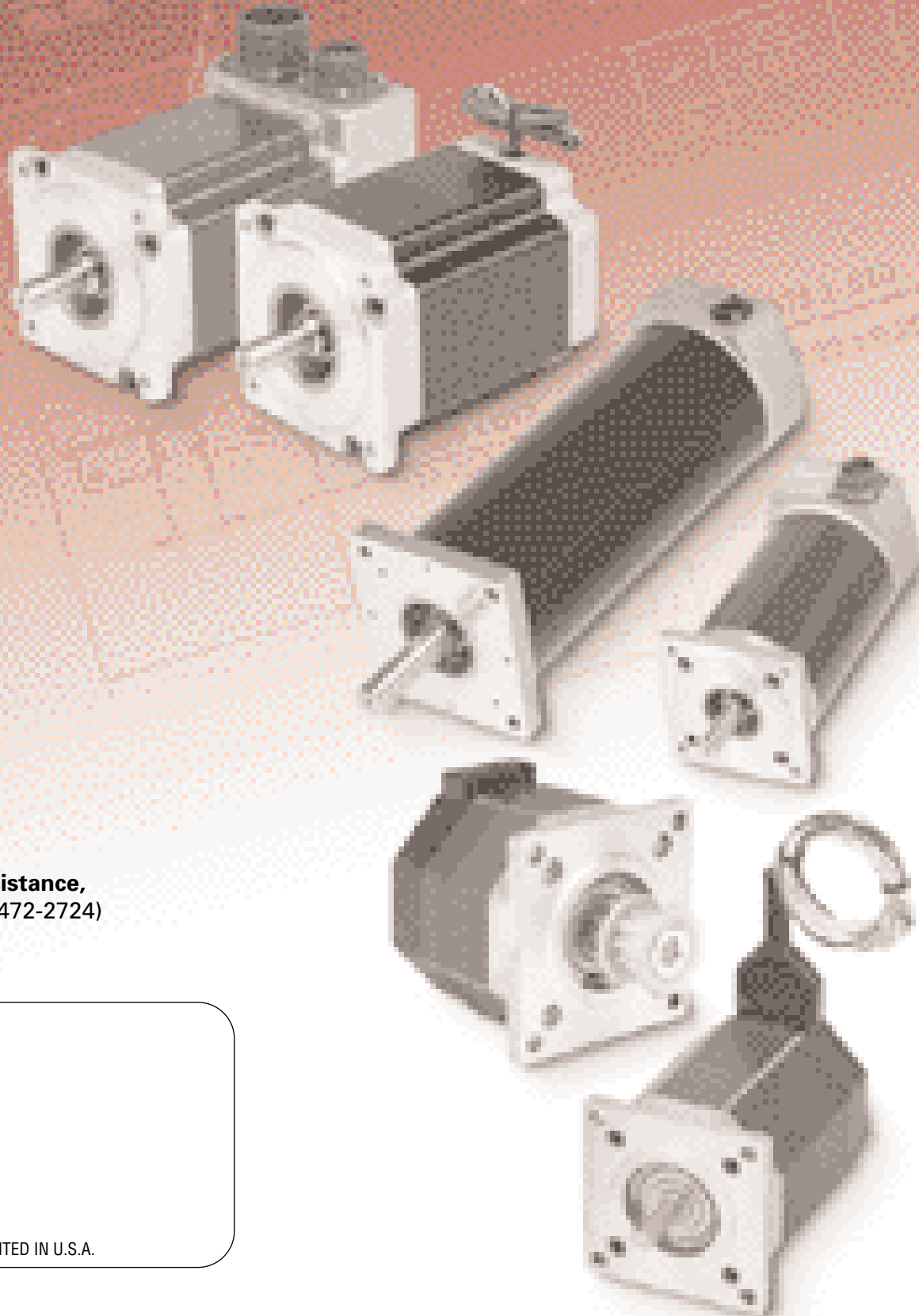

For application-specific assistance,
call **1-888-4PACSCI** (888-472-2724)
www.pacsci.com