

 **Kawasaki**

K3VG

**Swash-plate Type Axial Piston Pumps
for Open Circuits in
General Industrial Machinery**

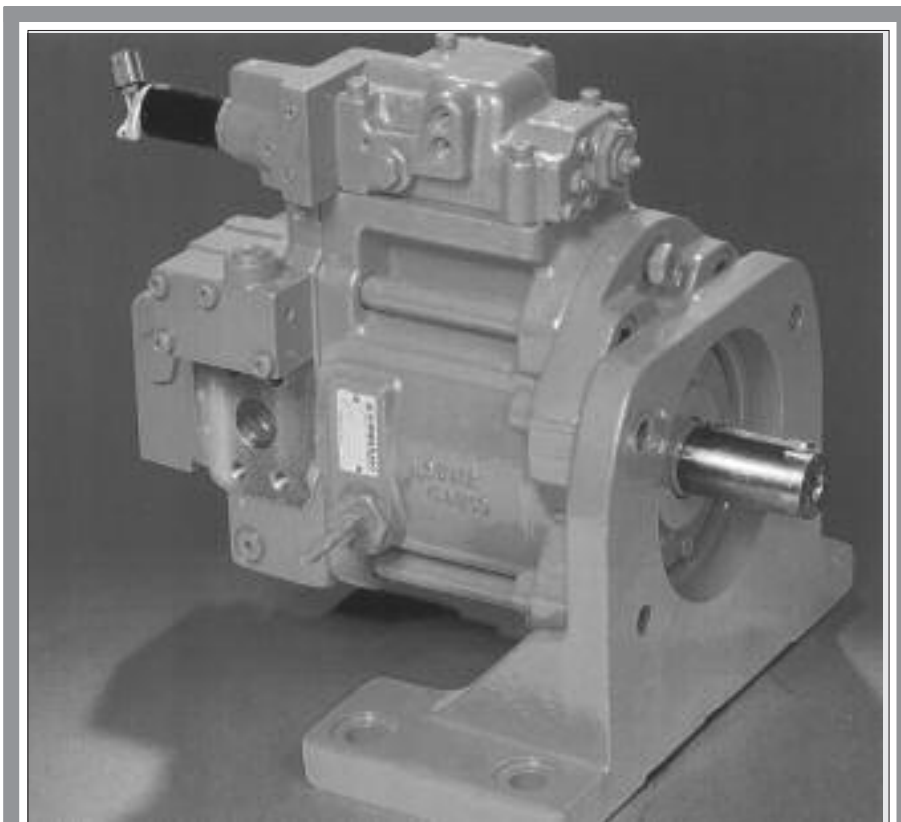

Contents

- 1. General Description.....1
- 2. Specifications1
- 3. Model Coding2
 - Pump and Accessories.....2
 - Regulator Ordering Code3
 - Horsepower Set Codes4
 - Horsepower Adjustment Range5
 - Functional Description of Regulators6-8
- 4. C-B10 Proportional Amplifier9
- 5. Pump Controls.....10-11
- 6. Performance and Flow Control Curves.....12-13
 - Overall Efficiency12-13
 - Self Priming Capability.....12-13
 - Bearing Life12-13
 - Noise Level12-13
 - Flow Control Curves14-15
- 7. Mounting Precautions.....16
- 8. Filtration.....17
- 9. Hydraulic Fluid Requirements17
- 10. Initial Start-up17
- 11. Drive Shaft Coupling17
- 12. Installation Drawings18-21

1 General Description

The K3VG Series Swash Plate Type Axial Piston Pumps are designed to specifically satisfy the industrial open circuit market where noise, efficiency, controllability and extended pump life are considered to be essential. K3VG Pumps are available in nominal displacements ranging from 3.84 to 34.2 in³/rev (63 to 560 cm³/rev) with various pressure, flow, and combination control options.

Key features of K3VG Pumps include:

- 1. Reliable, High Pressure and Long Life Design** - The K3VG Series Design is based on the K3V Mobile Series Pump where more than 700,000 units have been supplied to the Construction Machinery Market. The K3VG pump incorporates high load bearings and a friction free contacting mechanism for the piston-shoes. This design has resulted in a pump with high reliability and long service life.
- 2. Low Noise** - The unique, compact and rigid housing construction in addition to the semi-cylindrical pillow type swash-plate and its anti-vibration supporting mechanism has significantly reduced noise levels.
- 3. High Efficiency and High Self-Priming Capability** - K3VG Pumps encompass a spherical shaped valve plate design and improved hydraulic balancing which provide stable cylinder rotation, thus achieving high efficiency even in low-pressure, low-speed operating conditions. The spherical shaped valve plate also enables a shortened radius of the cylinder ports, which reduces the peripheral velocity and pressure-drop. This feature significantly improves the self-priming capability of the pump.
- 4. Extensive Range of Control Options** - A large variety of hydromechanical and hydroelectric control methods are available. Displacement, pressure cutoff, horsepower control, and various combinations of these controls are available.
- 5. Auxiliary Gear Pump** - Various sizes of optional gear pumps can be provided. Therefore, no separate pump unit is necessary as a control pressure source or system medium-pressure source and possible to attach high pressure gear pump. Hydraulic units can thus be made compact and more economical.

2 Specifications

Pump Model		63	112	180	280	180DT	280DT
Displacement	in ³ (cm ³ /rev)	3.84 (63)	6.83 (112)	11.0 (180)	17.1 (280)	22.0 (360)	34.2 (560)
¹ Rated Pressure	psi (bar)	5075 (350)	5075 (350)	5075 (350)	5075 (350)	5075 (350)	5075 (350)
² Peak Pressure	psi (bar)	5800 (400)	5800 (400)	5800 (400)	5800 (400)	5800 (400)	5800 (400)
Max Input Torque	lb-ft (Nm)	232 (314)	412 (559)	665 (902)	1032 (1400)	1330 (1804)	2065 (2800)
³ Max Self Priming Speed	rpm	2600	2200	1850	1600*	1850	1600*
⁴ Max Boosted Speed	rpm	3250	2700	2300	2000	2300	2000
Mass	lb (kg)	106 (48)	150 (68)	190 (86)	353 (160)	353 (160)	661 (300)

Fluid Operating Temperature Range -4° F ~ 176° F (-20° ~ 80° C)

Hydraulic Fluid Mineral Anti-wear Hydraulic Fluid
10 to 1000 cSt
For fluids over 200 cSt please contact Kawasaki
For other fluid types please contact Kawasaki

Fluid Cleanliness 19/16/14 ISO/DIS 4406
(NAS Class 9)

Filtration Suction-line: 150-μ mesh
Return line: 10-μ nominal or better

*Precautions must be taken when operating the K3VG280/DT at 1800 rpm. In order to prevent damage to the pump:

Suction Pressure	Maximum Displacement
+7.1 psi (0.5 bar)	280 cc/rev
0 psi (0 bar)	250 cc/rev
-1.4 psi (-0.1 bar)	232 cc/rev

¹ Consult bearing life charts for high horsepower applications.

Please contact Kawasaki for application assistance.

² Maximum allowable safety relief valve setting.

³ Steady State Suction Pressure ≥-1.45 psi (-2.95 in Hg), (-0.1 bar)

⁴ Minimum Recommended Boost Pressure at Suction Port ≥14.5 psi (29.52 in Hg), (1 bar)

3 Model Coding

PUMP AND ACCESSORIES

K3VG 180DT - 1 A N R S - 1PM1 -01
 [1] [2] [3] [4] [5] [6] [7] [8] [9] [10] [11]

[1] K3VG Series Variable Displacement, Axial Piston, Open Loop Pump

[2] Maximum Displacement

Single type	63	63 cm ³ /rev
	112	112 cm ³ /rev
	180	180 cm ³ /rev
	280	280 cm ³ /rev
Tandem type	180DT	360 cm ³ /rev
	280DT	560 cm ³ /rev

[3] Hydraulic Fluid Type.....- Mineral oil
 W Water glycol
 Z Phosphate ester

[4] Circuit Type.....1 Open loop

[5] Attached Gear Pump.....0 Without gear pump
 1 10 cm³/rev with built in relief valve
 580 psi setting (725 psi max)
 (not available on tandem)
 2 15 cm³/rev with built in relief valve
 580 psi setting (725 psi max)
 (not available on tandem)
 3 Without gear pump, with pilot port
 4 ~ D With mounting provisions for gear pump (see page 20)

[6] Mounting Bracket/Port Flanges.....N No bracket, no flange (order separately, see page 20-21)

[7] Direction of Rotation.....R Clockwise
 (viewed @ shaft end) L Counterclockwise (tandem only)

[8] Design Series.....blank Installation and performance details remain
 S unaltered for both design series.

[9] Mounting Orientation.....- Standard horizontal mounting
 V Vertical mounting

[10] Regulator Code**** See page 3

[11] Auxiliary Gear Pump.....blank Single pump or tandem pump without gear pump
 -01 Tandem Pump with auxiliary gear pump

REGULATOR ORDERING CODE

K3VG180DT - 1ANR - 1 P M 1 - 01
 [10.1] [10.2] [10.3] [10.4]

[10.1] Horsepower/Pressure Control	0	Without Horsepower or Pressure Cutoff Control
	1	Horsepower Control
	5	Horsepower and Pressure Cutoff Control
	6	Pressure Cutoff Control with Remote Pressure Cutoff Control Capability
	7	Horsepower and Pressure Cutoff Control with Remote Pressure Cutoff Control Capability
[10.2] Flow Control	0	Without Flow Control
	P	Positive Flow Control
	N	Negative Flow Control
	E	Electric Control
	L	Load Sense Control
[10.3] Power Control Mode.....	H	High Horsepower Band
	M	Medium Horsepower Band
	L	Low Horsepower Band
	0	No horsepower control
[10.4] Power Setting Code	1 - 5	See tabulations on page 4
	A, B	
	0	No horsepower control

STANDARD GEAR PUMP ARRANGEMENTS

An auxiliary gear pump is available to provide a pilot signal to the flow control mechanism of the K3VG regulator. The optimum capacity gear pump for each K3VG pump is tabulated in the table below. The auxiliary gear pumps have an integrated relief valve set at 560 psi.

Pump Size and Ordering Code	Gear Pump Displacement
K3VG63 - 11### - ####	10.0 cm ³ /rev
K3VG112 - 11### - ####	10.0 cm ³ /rev
K3VG180 - 11### - ####	10.0 cm ³ /rev
K3VG280 - 12### - ####	15.0 cm ³ /rev
K3VG180DT - 1A### - #### - 01	25.3 cm ³ /rev
K3VG280DT - 1A### - #### - 01	32.5 cm ³ /rev

HORSEPOWER SET CODES

Standard Regulator at 1200 rpm

Motor Power hp (kw)	K3VG Pump Frame Size					
	63	112	180	280	180DT	280DT
15 (11.2)	L2					
20 (14.9)	M2					
25 (18.6)	H5	L2				
30 (22.4)	H3	M4				
40 (29.8)		M1	L1			
50 (37.3)		H4	M3			
60 (44.7)		H2	M2	L2		
75 (55.9)			H5	M5	L3	
100 (74.6)			H1	M1	M3	L4
125 (93.2)				H3	M1	L2
150 (111.9)				H1	H3	M4
200 (149.1)					HA	MA
250 (186.4)						H5
300 (223.7)						H2

Example:

Pump: K3VG112-10NR-10??
 Electric Motor: 50hp at 1800 rpm
 Horsepower Set Code: M3
 Final Model Code: K3VG112-10NR-10**M3**

Standard Regulator at 1500 rpm

Motor Power hp (kw)	K3VG Pump Frame Size					
	63	112	180	280	180DT	280DT
15 (11.2)	L4					
20 (14.9)	L1					
25 (18.6)	M2					
30 (22.4)	M1	L3				
40 (29.8)	H2	M3	L3			
50 (37.3)		M1	L1			
60 (44.7)		H5	M4			
75 (55.9)		H3	M2	L2		
100 (74.6)			H4	M4	L2	
125 (93.2)			H2	M2	M4	
150 (112)				H4	M2	L3
200 (149)					H4	MB
250 (186.4)					HA	MA
300 (224)						HA
350 (261)						HB

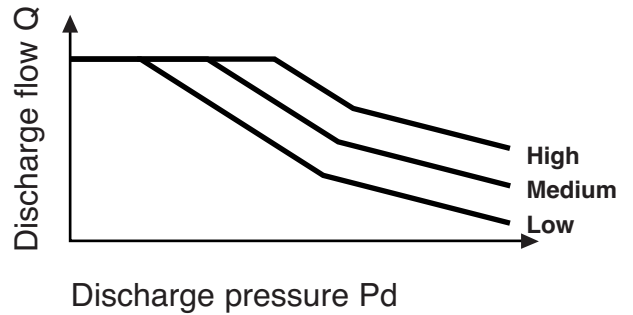

Standard Regulator at 1800 rpm

Motor Power hp (kw)	K3VG Pump Frame Size					
	63	112	180	280*	180DT	280DT*
20 (14.9)	L3					
25 (18.6)	L1					
30 (22.4)	M2					
40 (29.8)	H4	L1				
50 (37.3)	H2	M3	L3			
60 (44.7)		M1	L1			
75 (55.9)		H5	M4			
100 (74.6)		H1	M1	L1*	L4	
125 (93.2)			H4	M4*	L2	
150 (111.9)			H2	M2*	M4	
200 (149.1)				HA*	MA	LA*
250 (186.4)					HB	MB*
300 (223.7)					HA	MA*
350 (261.0)						HA*
400 (298.3)						H4*
450 (335.6)						H2*

*See precaution for operating K3VG280 and K3VG280DT at 1800 rpm on page 1.

HORSEPOWER ADJUSTMENT RANGE

The horsepower setting can be adjusted via external adjusting screws. The adjustment range of each horsepower control mode is given in the tables below.

K3VG63

Horsepower control mode		1200 rpm hp (kW)	1500 rpm hp (kW)	1800 rpm hp (kW)
H	High horsepower	23.5~35.9 (17.5~26.8)	29.5~45.3 (22.0~33.8)	35.6~54.7 (26.6~40.8)
M	Medium horsepower	16.6~23.9 (12.4~17.8)	20.9~30.0 (15.6~22.4)	25.3~36.3 (18.9~27.1)
L	Low horsepower	11.3~20.1 (8.4~15.0)	14.2~25.3 (10.6~18.9)	17.2~30.6 (12.8~22.8)

K3VG112

Horsepower control mode		1200 rpm hp (kW)	1500 rpm hp (kW)	1800 rpm hp (kW)
H	High horsepower	39.3~33.1 (29.3~49.3)	49.6~83.2 (37.0~62.1)	59.8~100.5 (44.6~75.0)
M	Medium horsepower	28.8~48.4 (21.5~36.1)	36.3~61.1 (27.1~45.6)	43.8~73.7 (32.7~55.0)
L	Low horsepower	20.2~32.6 (15.1~24.3)	25.6~41.2 (19.1~30.7)	30.8~49.6 (23.0~37.0)

K3VG180

Horsepower control mode		1200 rpm hp (kW)	1500 rpm hp (kW)	1800 rpm hp (kW)
H	High horsepower	59.4~102.5 (43.6~76.5)	73.7~129.3 (55.0~96.5)	89.0~156.0 (66.4~116.4)
M	Medium horsepower	46.6~79.8 (34.8~59.5)	58.8~100.5 (43.9~75.0)	71.0~121.3 (53.0~90.5)
L	Low horsepower	31.8~48.4 (23.7~36.1)	40.1~61.1 (29.9~45.6)	48.4~73.7 (36.1~55.0)

K3VG280

Horsepower control mode		1200 rpm hp (kW)	1500 rpm hp (kW)	1800 rpm hp (kW)
H	High horsepower	95.7~159.6 (71.4~119.1)	120.6~201.2 (90.0~150.1)	180.0~220.0 (134.3~164.0)
M	Medium horsepower	71.6~120.6 (53.4~90.0)	90.2~152.1 (67.3~113.5)	120.0~180.0 (89.5~134.3)
L	Low horsepower	49.7~79.7 (37.1~59.5)	62.7~100.5 (46.8~75.0)	80.0~125.0 (59.7~93.3)

K3VG180DT

Horsepower control mode		1200 rpm hp (kW)	1500 rpm hp (kW)	1800 rpm hp (kW)
H	High horsepower	116.2~205.1 (86.7~153.0)	146.6~258.5 (109.4~192.9)	176.9~312.2 (132.0~232.9)
M	Medium horsepower	93.4~143.0 (69.7~106.7)	117.8~180.3 (87.9~134.5)	142.1~217.7 (106.0~162.4)
L	Low horsepower	63.7~96.9 (47.5~72.3)	80.3~122.1 (59.9~91.1)	96.9~147.4 (72.3~110.0)

K3VG280DT

Horsepower control mode		1200 rpm hp (kW)	1500 rpm hp (kW)	1800 rpm hp (kW)
H	High horsepower	209.8~319.1 (156.5~238.1)	264.4~402.5 (197.3~300.3)	290.0~450.0 (216.0~335.0)
M	Medium horsepower	145.8~254.3 (108.8~189.7)	183.9~320.6 (137.2~239.2)	240.0~310.0 (179.0~231.0)
L	Low horsepower	99.5~170.1 (74.2~126.9)	125.3~214.5 (93.5~160.0)	160.0~245.0 (119.0~183.0)

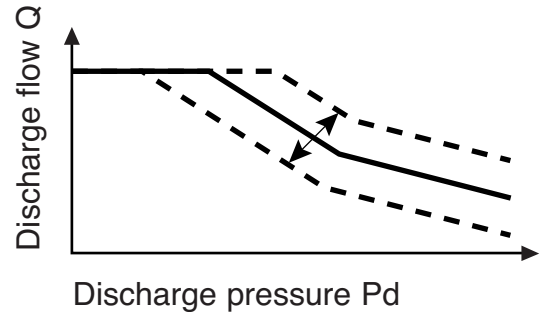

FUNCTIONAL DESCRIPTION OF REGULATORS

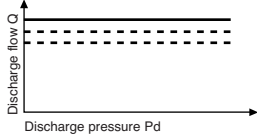
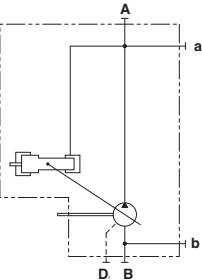
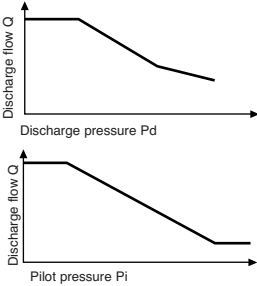
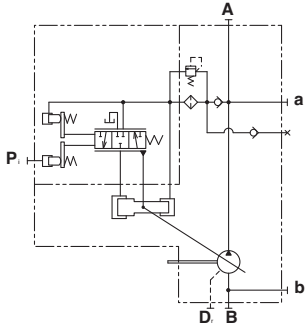
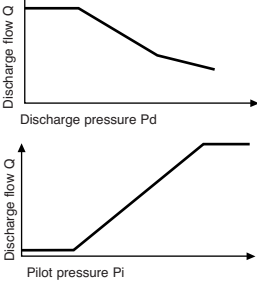
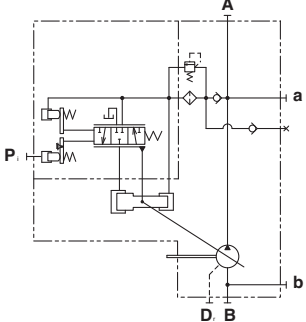
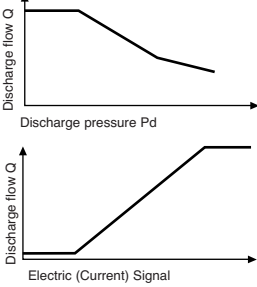
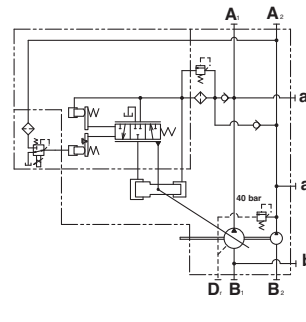
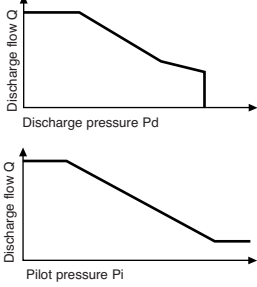
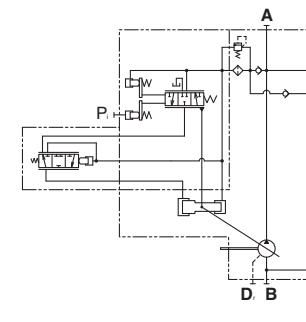
Regulator Code	Control Curves	Hydraulic Circuit
<p>0000 Stepless Manual Displacement Control The pump is supplied without a regulator. The discharge flow can be steplessly adjusted by manually turning adjustment screws on the pump. This adjustment provision is a standard feature on all K3VG pumps providing a means to limit the maximum and minimum displacement.</p>	 <p>Range of Flow Control 50-100%</p>	
<p>10## Horsepower Control 1N## Horsepower and Negative Flow Control In response to a rise in delivery pressure, the swash plate tilting angle is decreased, restricting the input torque. This regulator prevents excessive load against the prime mover. By adding a pilot signal to the Pi port the discharge flow can be infinitely adjusted within the range of the pump. An increase in pilot signal will result in a decrease in flow, hence the Negative control.</p>	 <p>Range of Flow Control 100-15%</p>	
<p>1P## Horsepower and Positive Flow Control This regulator combines the Horsepower Control with Positive Flow Control. By adding a pilot signal to the Pi port the discharge flow can be infinitely adjusted within the range of the pump. An increase in pilot signal will result in an increase in flow, hence the Positive control.</p>	 <p>Range of Flow Control 2.5-100%</p>	
<p>1E## Horsepower and Electric Flow Control This regulator combines the Horsepower Control with Electric Flow Control. A proportional reducing valve is added to the regulator so the discharge flow can be infinitely adjusted within the range of the pump. An increase in electric signal to the proportional reducing valve will result in an increase in flow. This regulator requires an amplifier (refer to page 9) to provide the electric signal.</p>	 <p>Range of Flow Control 2.5-100%</p>	
<p>50## Horsepower and Pressure Cutoff 5N## Horsepower, Pressure Cutoff and Negative Flow Control This regulator combines the Horsepower Control with Pressure Cutoff Control. By adding a pilot signal to the Pi port the discharge flow can be infinitely adjusted within the range of the pump. An increase in pilot signal will result in a decrease in flow, hence the Negative control.</p>	 <p>Range of Flow Control 100-15%</p>	

FUNCTIONAL DESCRIPTION OF REGULATORS (continued)

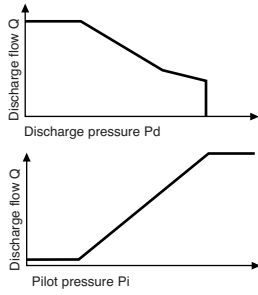
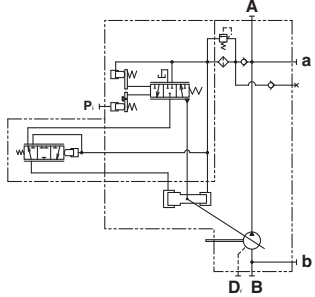
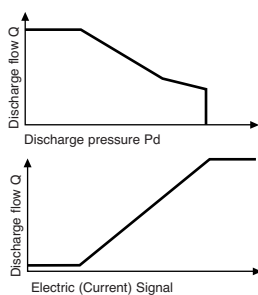
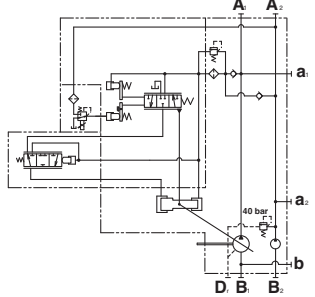
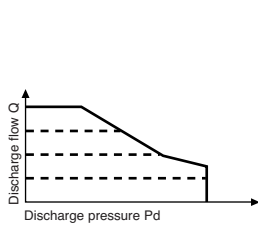
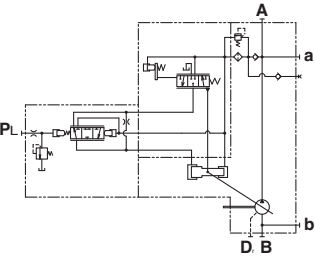
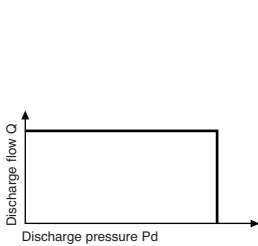
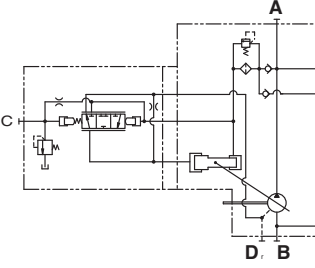
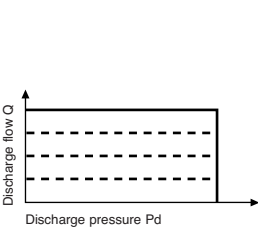
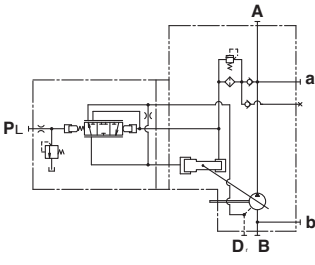
Regulator Code	Control Curves	Hydraulic Circuit
<p>5P## Horsepower, Pressure Cutoff and Positive Flow Control This regulator combines the Horsepower Control with Pressure Cutoff Control. By adding a pilot signal to the Pi port the discharge flow can be infinitely adjusted within the range of the pump. An increase in pilot signal will result in an increase in flow, hence the Positive control.</p>	 <p>Range of Flow Control 2.5-100%</p>	
<p>5E## Horsepower, Pressure Cutoff and Electric Flow Control This regulator combines the Horsepower Control with Pressure Cutoff and Electric Flow Control. A proportional reducing valve is added to the regulator so the discharge flow can be infinitely adjusted within the range of the pump. An increase in electric signal to the proportional reducing valve will result in an increase in flow. This regulator requires an amplifier (refer to page 9) to provide the electric signal.</p>	 <p>Range of Flow Control 2.5-100 %</p>	
<p>5L## Horsepower and Load Sense Control This regulator combines Horsepower Control and Load Sense Control.</p>	 <p>Range of Flow Control 2.5-100%</p>	
<p>6000 Pressure Cutoff Control This regulator maintains a constant pressure regardless of the discharge flow. It is imperative that a safety relief valve is installed in the circuit. By connecting the Pc port to a remote pressure control, variable pump pressure control can be achieved. A subplate can be added to the regulator that will accommodate a "DO3" proportional relief valve for variable Pressure Cutoff Control.</p>		
<p>6L00 Load Sense Control This regulator controls the pump displacement to match the flow requirement as a function of load pressure. In addition, there is a Pressure Cutoff Function incorporated into the regulator.</p>	 <p>Range of Flow Control 2.5-100%</p>	

FUNCTIONAL DESCRIPTION OF REGULATORS (continued)

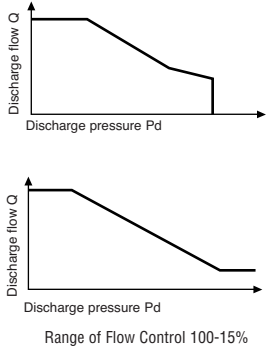
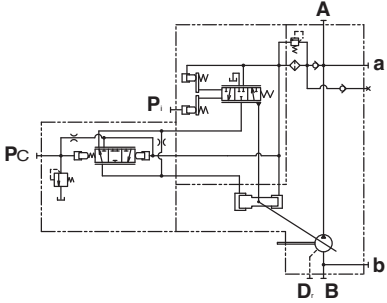
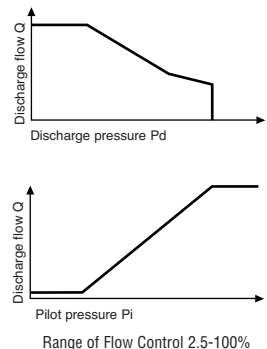
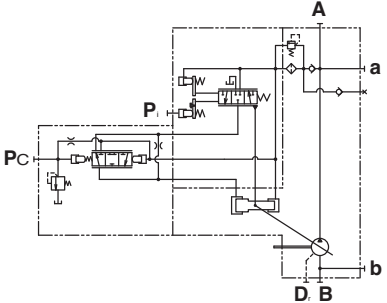
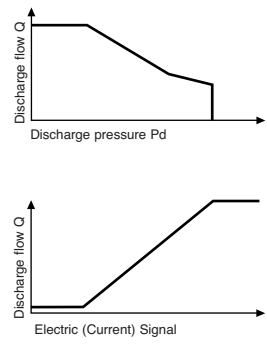
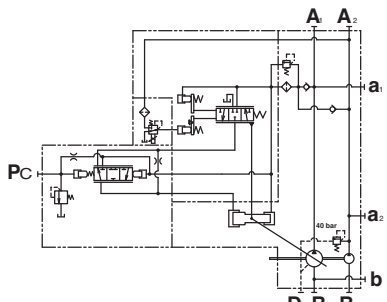
Regulator Code	Control Curves	Hydraulic Circuit
<p>70## Horsepower and Pressure Cutoff 7N## Horsepower, Pressure Cutoff and Negative Flow Control (with Remote Pressure Cutoff Capability)</p> <p>This regulator combines the Horsepower Control with Pressure Cutoff Control. By adding a pilot signal to the Pi port the discharge flow can be infinitely adjusted within the range of the pump. An increase in pilot signal will result in a decrease in flow, hence the Negative control.</p> <p>By connecting the Pc port to a remote pressure control, variable pump pressure control can be achieved.</p> <p>A subplate can be added to the regulator that will accommodate a "DO3" proportional relief valve for variable Pressure Cutoff Control.</p>	 <p>Range of Flow Control 100-15%</p>	
<p>7P## Horsepower, Pressure Cutoff and Positive Flow Control (with Remote Pressure Cutoff Capability)</p> <p>This regulator combines the Horsepower Control with Pressure Cutoff Control. By adding a pilot signal to the Pi port the discharge flow can be infinitely adjusted within the range of the pump. An increase in pilot signal will result in an increase in flow, hence the Positive control.</p> <p>By connecting the Pc port to a remote pressure control, variable pump pressure control can be achieved.</p> <p>A subplate can be added to the regulator that will accommodate a "DO3" proportional relief valve for variable Pressure Cutoff Control.</p>	 <p>Range of Flow Control 2.5-100%</p>	
<p>7E## Horsepower, Pressure Cutoff and Electric Flow Control (with Remote Pressure Cutoff Capability)</p> <p>This regulator combines the Horsepower Control with Pressure Cutoff and Electric Flow Control. A proportional reducing valve is added to the regulator so the discharge flow can be infinitely adjusted within the range of the pump. An increase in electric signal to the proportional reducing valve will result in an increase in flow. This regulator requires an amplifier (refer to page 9) provide the electric signal.</p> <p>By connecting the Pc port to a remote pressure control, variable pump pressure control can be achieved.</p> <p>A subplate can be added to the regulator that will accommodate a "DO3" proportional relief valve for variable Pressure Cutoff Control.</p>	 <p>Range of Flow Control 2.5-100%</p>	

4 C-B10-A###-21 Proportional Amplifier

Specifications

Supply Input Voltage (50/60Hz)	A100 / 110V ±10% A200 / 220V ±10%
Command Input Signal Voltage	0 ~ 10 VDC
Rated Output Current	750 mA
Maximum Output Current	1.0 A
Power Consumption	Maximum 40 VA
Load Resistance	45 Ω or less
Input Impedance	50 kΩ
Ambient Temperature Range	32 ~122° F (0 ~ 50° C)
Maximum Humidity	90% RH (no dew permissible)
Vibration Resistance (JIS C091 IIB Type 3)	Amplitude 0.12 in (3.0 mm) peak to peak Frequency 16.7 Hz
Insulation	100MW minimum at 500 VDC
Mass	6.8 lb (3.1 Kg)
Gain Adjustment Range	35 ~ 160 mA/V
Bias Adjustment Range	0 ~ 250 mA
Linearity	Up to 2% FS
Current Stability	Up to 1.0% FS (ambient temperature change 122° F) Up to 1.0% FS (for supply voltage change ± 10%) Up to 1.5% FS (load resistance change 33 ~ 45 Ω)
Supply Fuse	1.6 A
Dither Frequency Adjustment Range	50 ~ 200 Hz
Dither Amplitude Adjustment Range	0 ~ 250 mA Peak to Peak

Installation Drawing

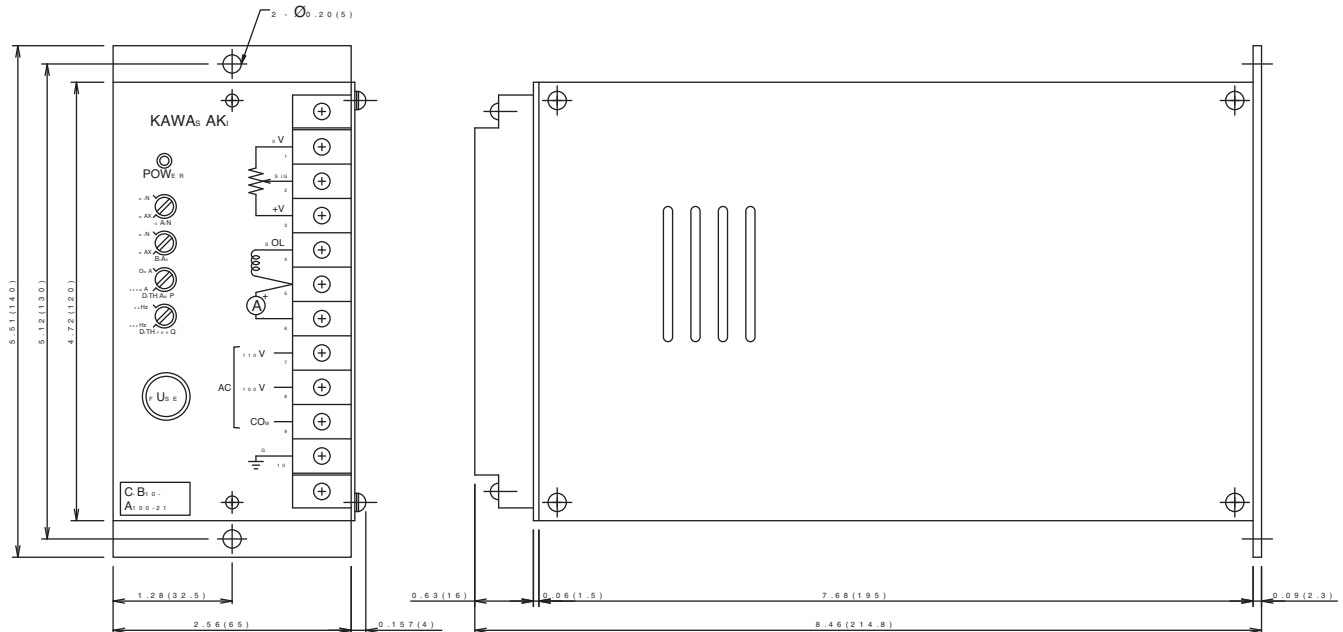

5 Pump Controls

Pump Controls — Type 1###

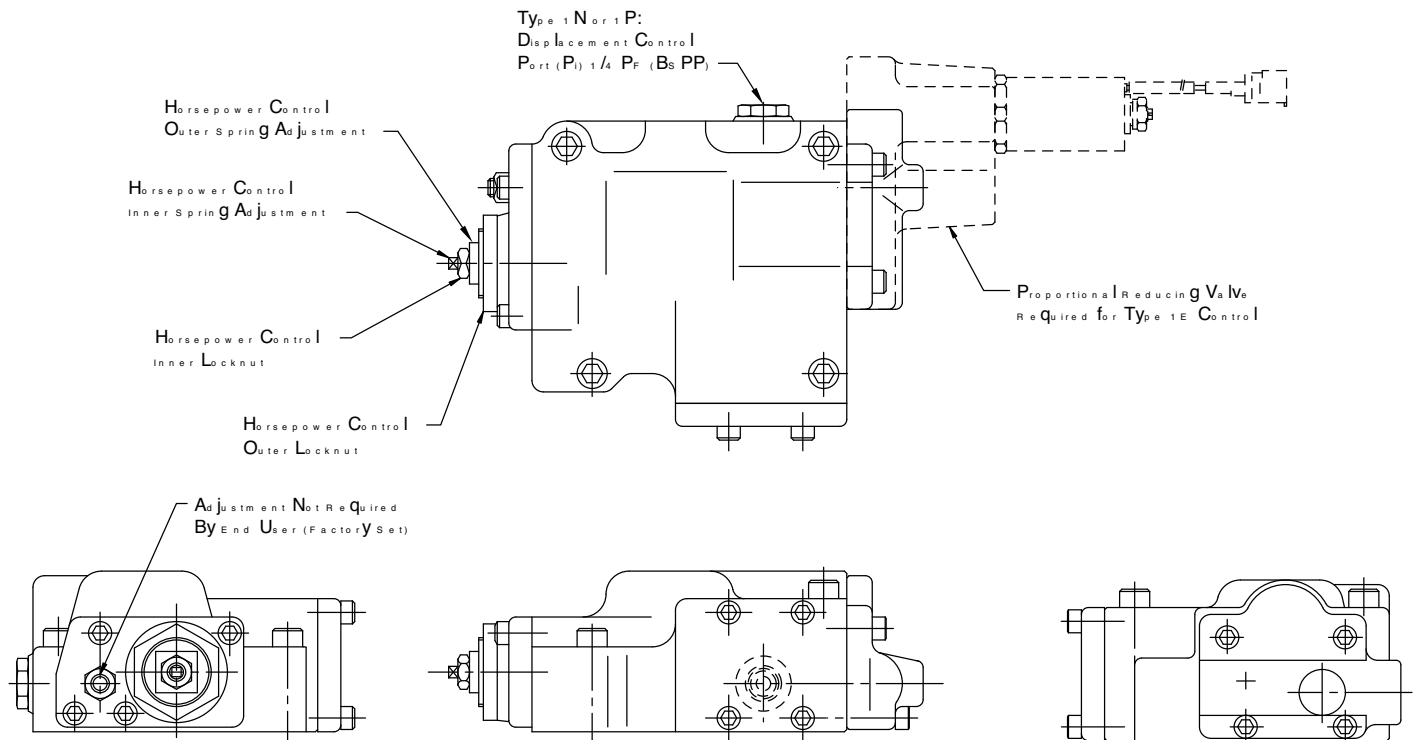

Pump Controls — Type 5### (See 7### for 5L##)

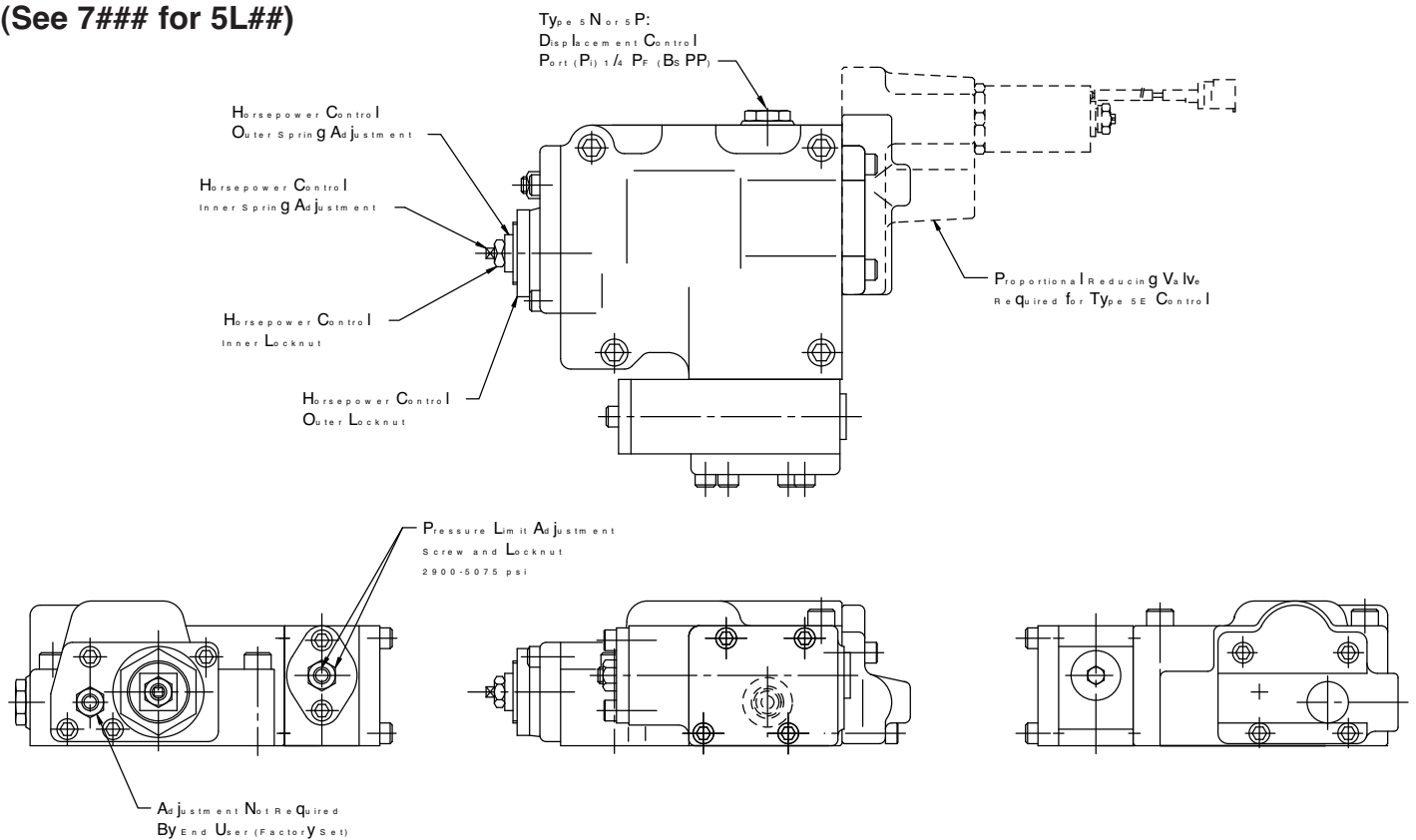

Pump Controls — Type 6#00

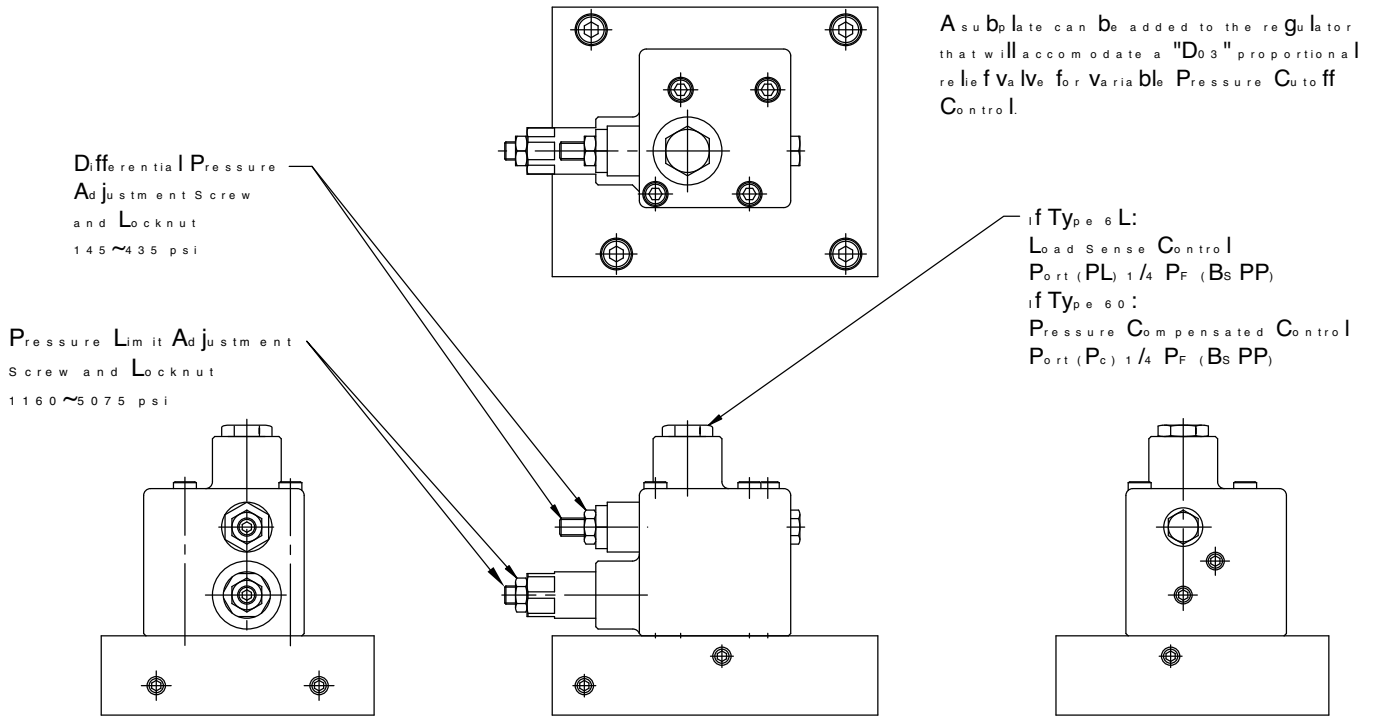

Pump Controls — Type 7### (Includes 5L##)

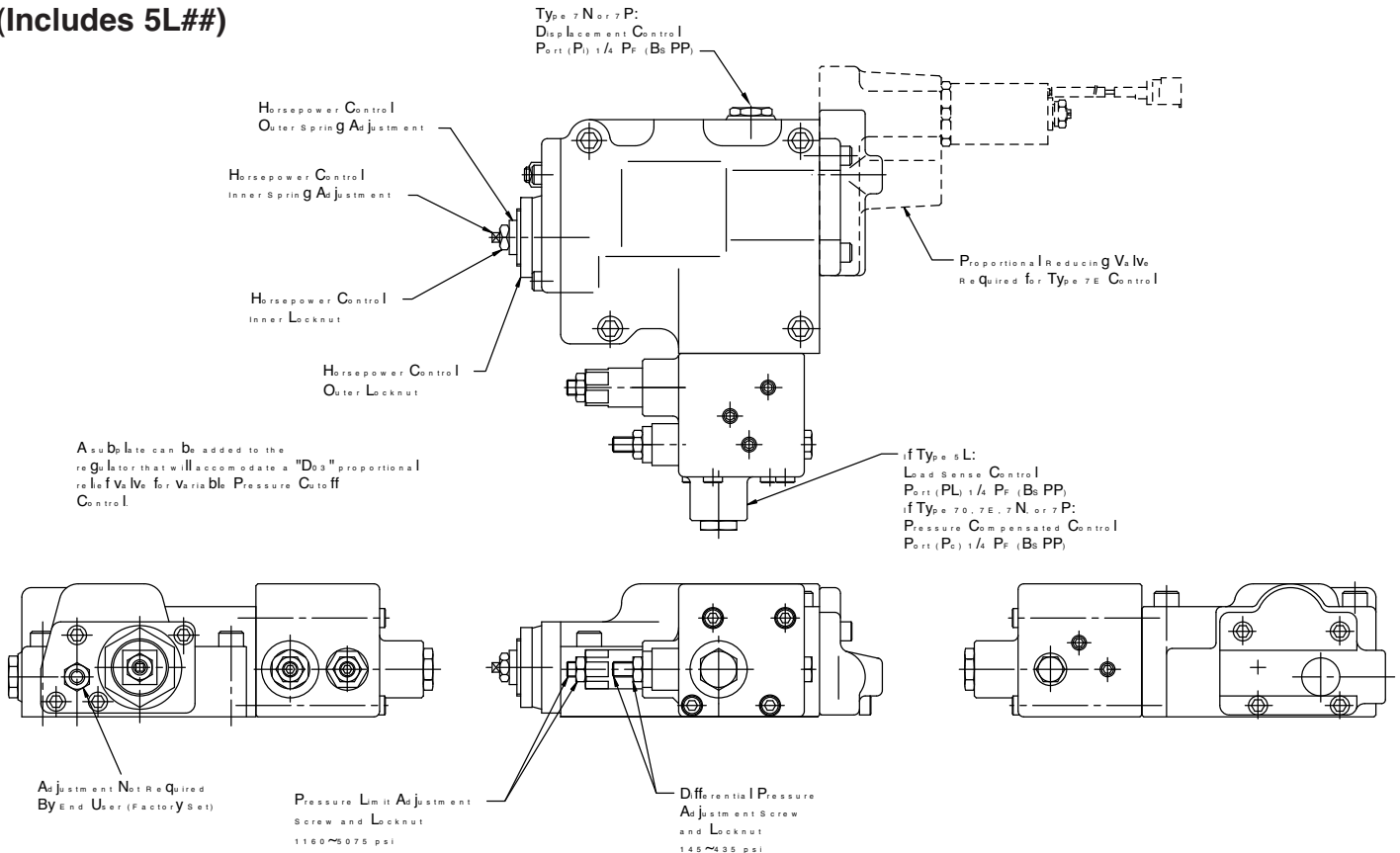

6 Performance and Flow Control Curves

K3VG63

Overall Efficiency (%)

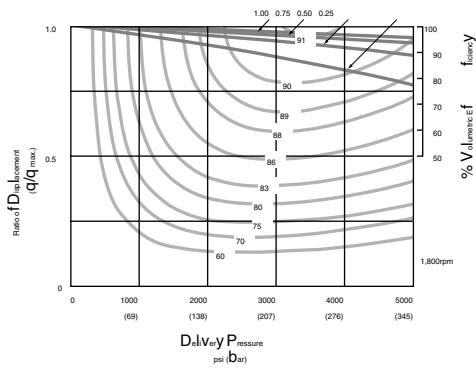

Self-Priming Capability

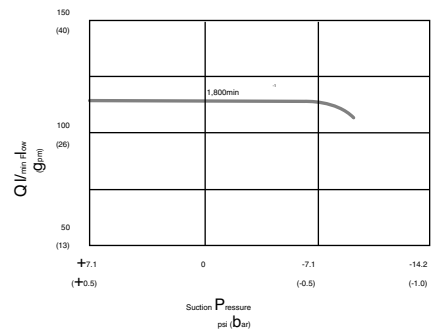

Bearing Life

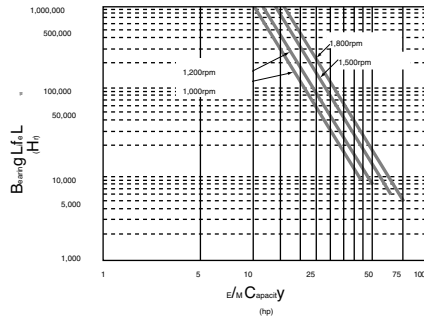

Noise Level

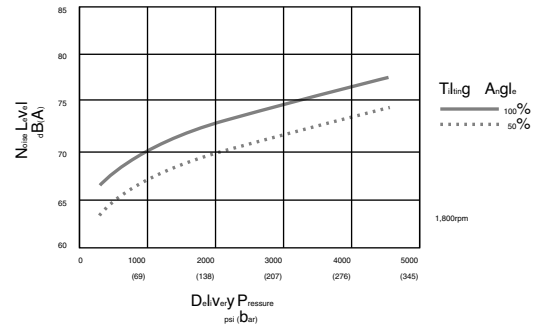

K3VG112

Overall Efficiency (%)

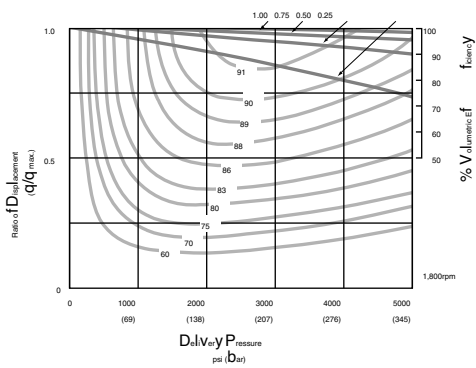

Self-Priming Capability

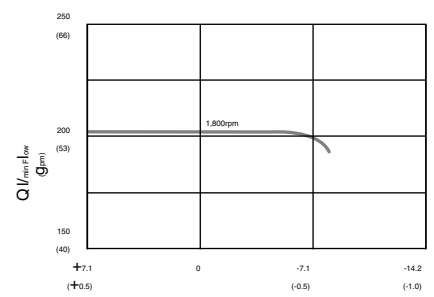

Bearing Life

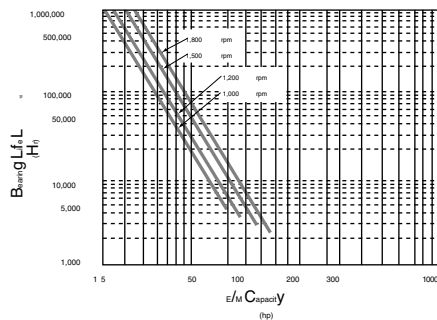

Noise Level

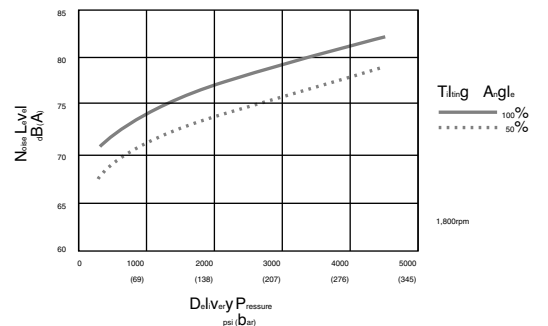

K3VG180/180DT

Overall Efficiency (%)

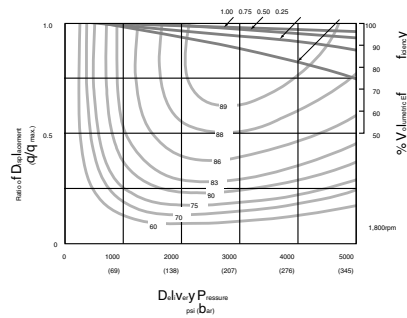

Self-Priming Capability

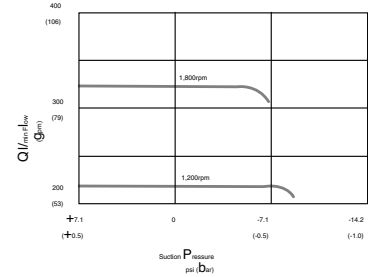

Bearing Life

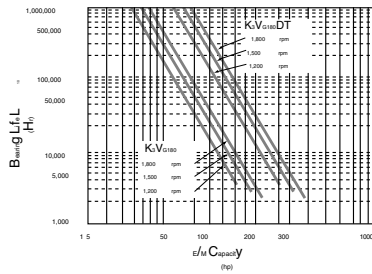

Noise Level K3VG180 (single)

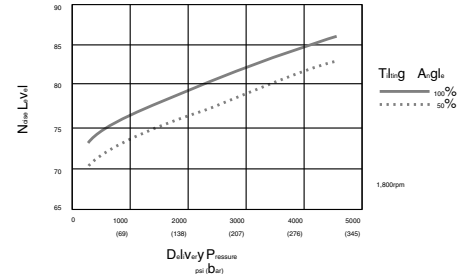

K3VG280/280DT

Overall Efficiency (%)

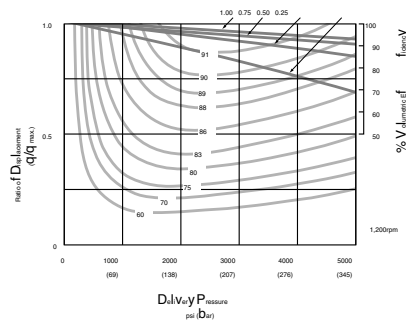

Self-Priming Capability

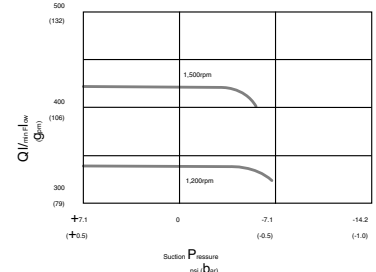

Bearing Life

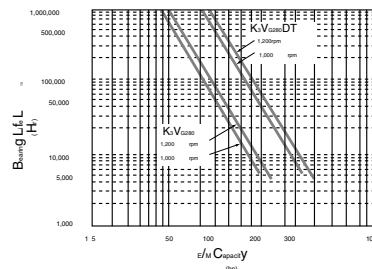

Noise Level K3VG280 (single)

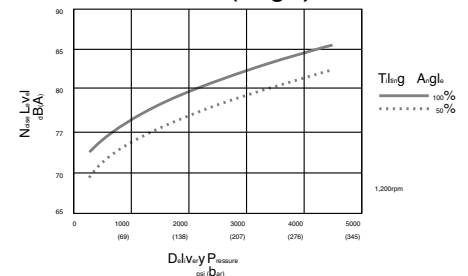

K3VG180DT/280DT

Noise Level K3VG180DT (tandem)

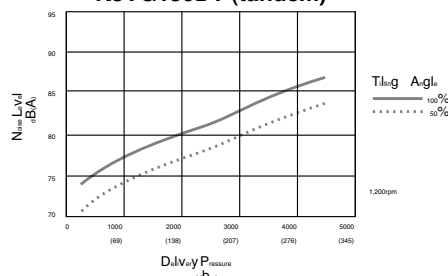

Noise Level K3VG280DT (tandem)

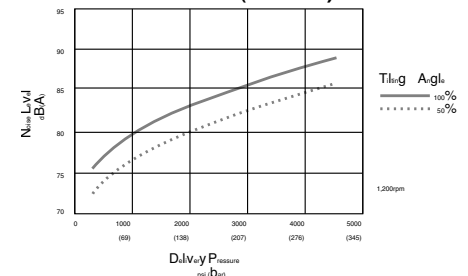

K3VG63 Flow Control Curves

Positive Flow Control (*P**)

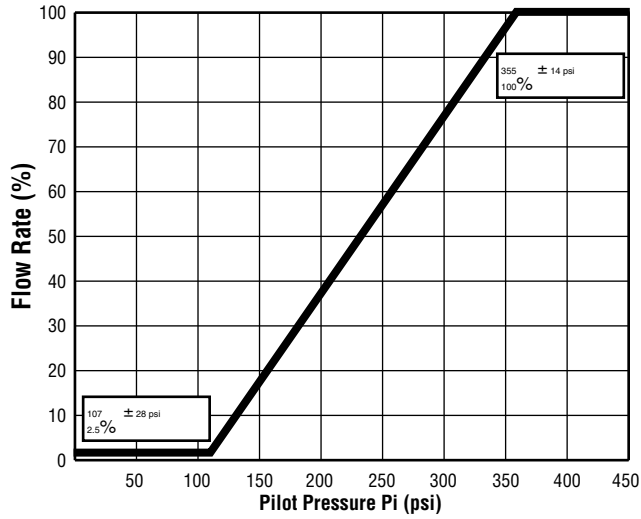

Negative Flow Control (*N**)

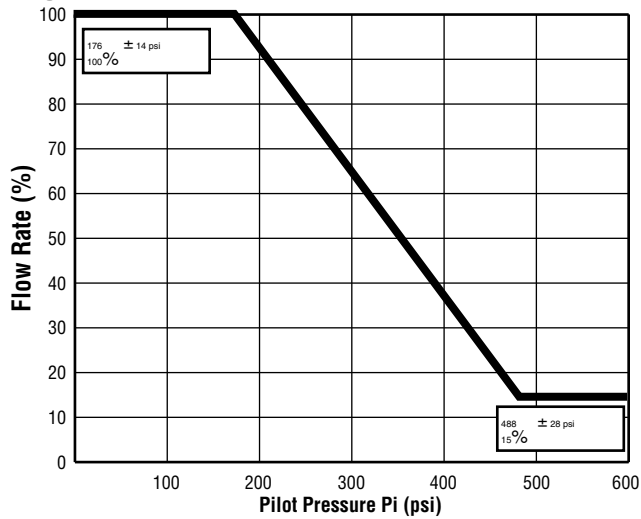

Electric Flow Control (*E**)

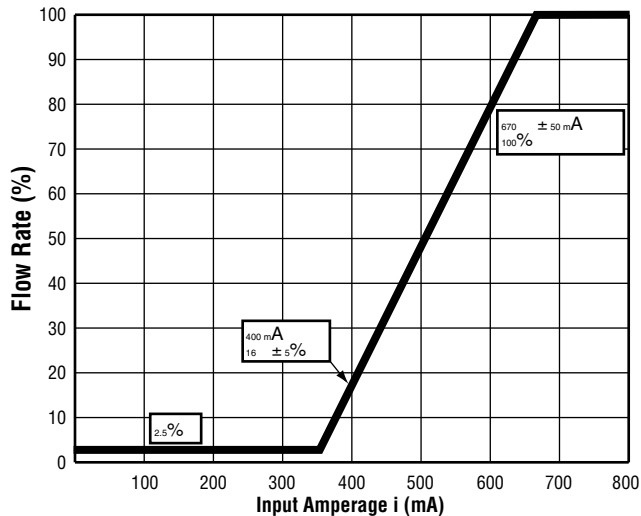

K3VG112 Flow Control Curves

Positive Flow Control (*P**)

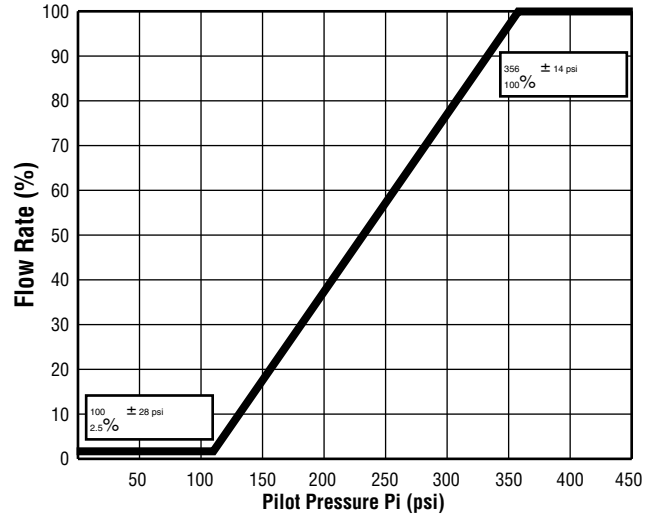

Negative Flow Control (*N**)

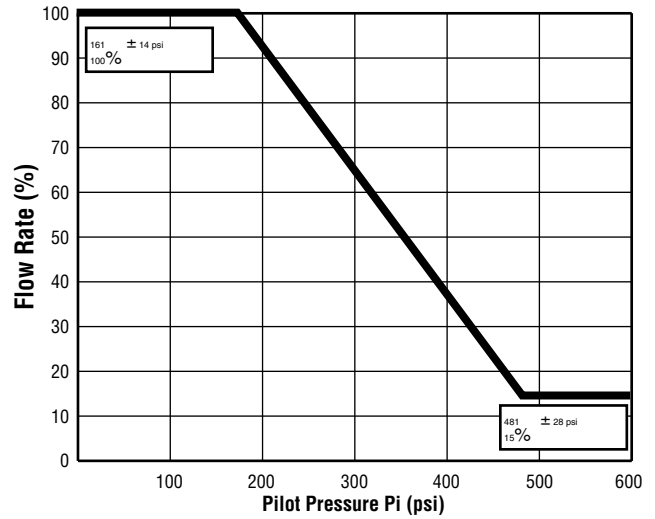

Electric Flow Control (*E**)

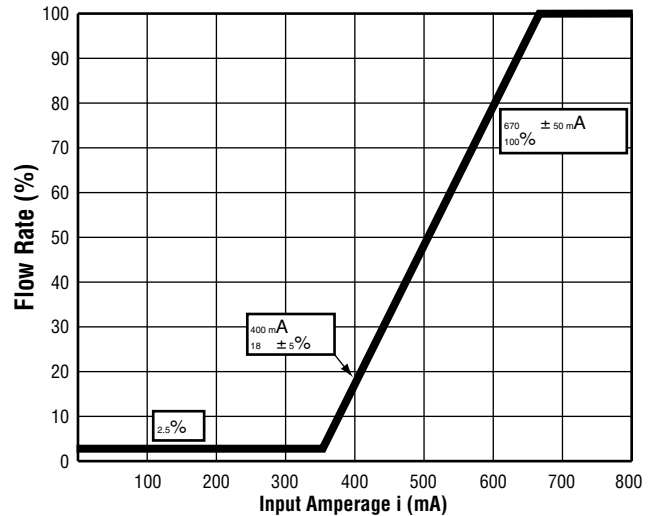

K3VG180 / 180DT Flow Control Curves

Positive Flow Control (*P**)

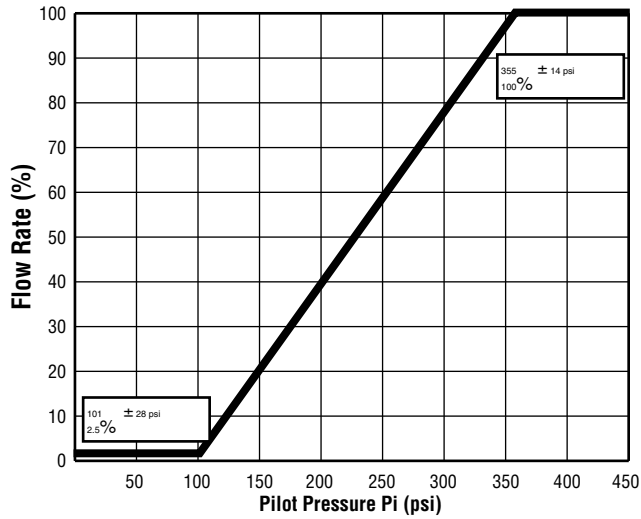

Negative Flow Control (*N**)

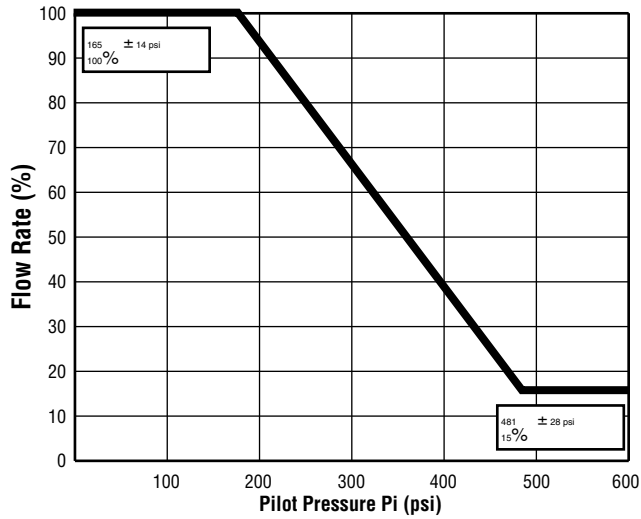

Electric Flow Control (*E**)

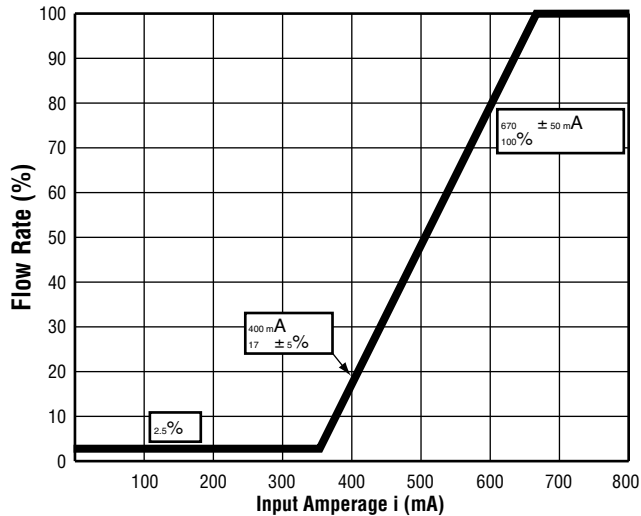

K3VG280 / 280DT Flow Control Curves

Positive Flow Control (*P**)

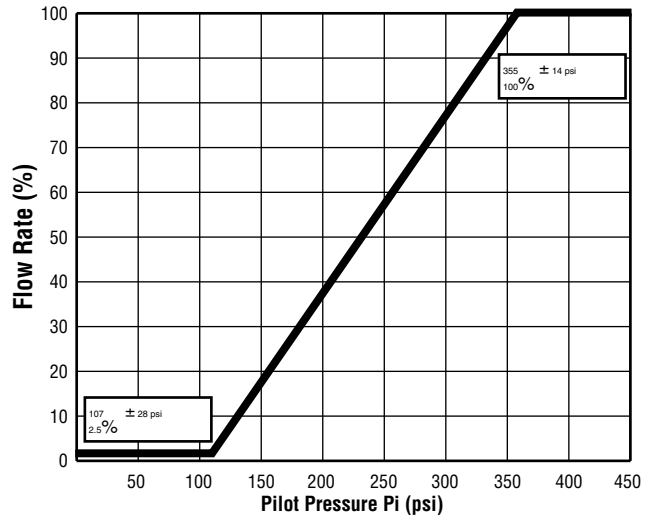

Negative Flow Control (*N**)

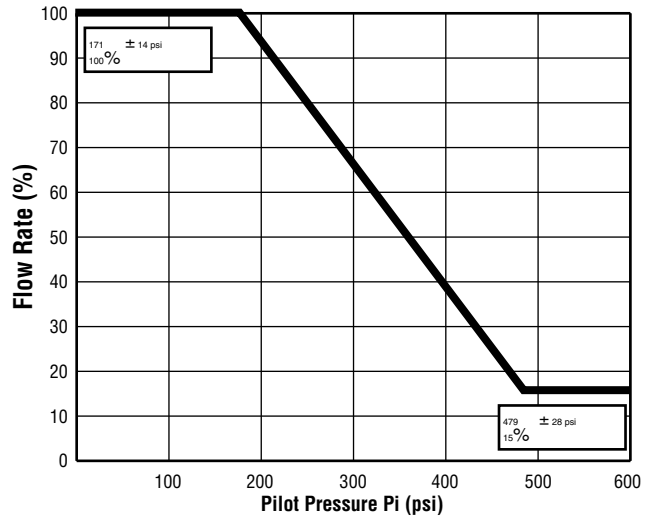

Electric Flow Control (*E**)

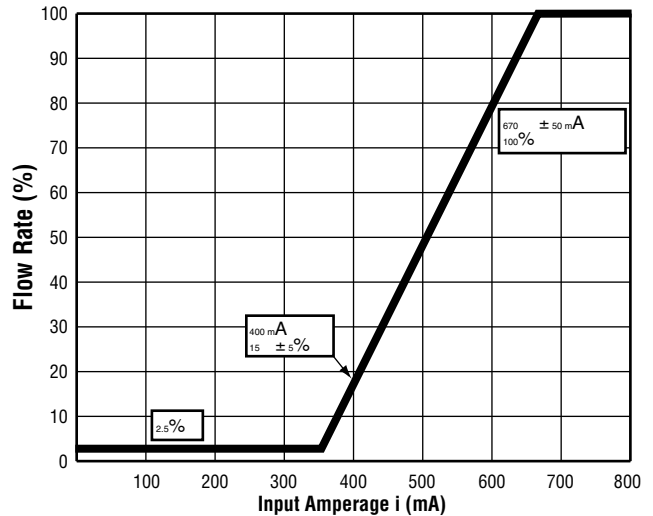

7 Mounting Precautions

Recommended pump mounting

The pump should be mounted horizontally with the case drain piping initially rising above the level of the pump before continuing to the tank as shown in the illustration below. Do not connect the drain line to the suction line.

The uppermost drain port should be used and the drain piping should be equal or larger in size than the drain port to minimize pressure in the pump case. The pump case pressure should not exceed 30 psi (2.1 bar) as shown in the illustration below. (Peak pressure should never exceed 85 psi [5.9 bar].)

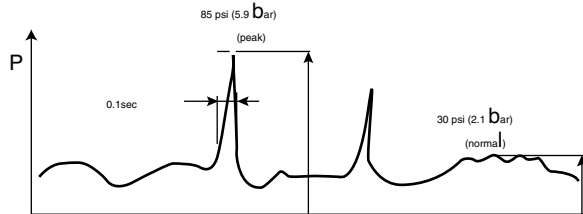

Mounting the pump above the tank

If the pump is to be mounted above the level of the tank the suction line must initially rise above the level of the pump before continuing to the tank as shown in the illustration below. The “goose neck” configuration is required because there is a very small bleed orifice between the case and the suction line within the valve plate as such one needs this inlet condition to ensure case oil is not drained. The maximum allowable height the pump can be mounted above the tank is 3.3 feet (1 meter). The minimum suction pressure should be -1.45 psi (-0.1 bar) or above.

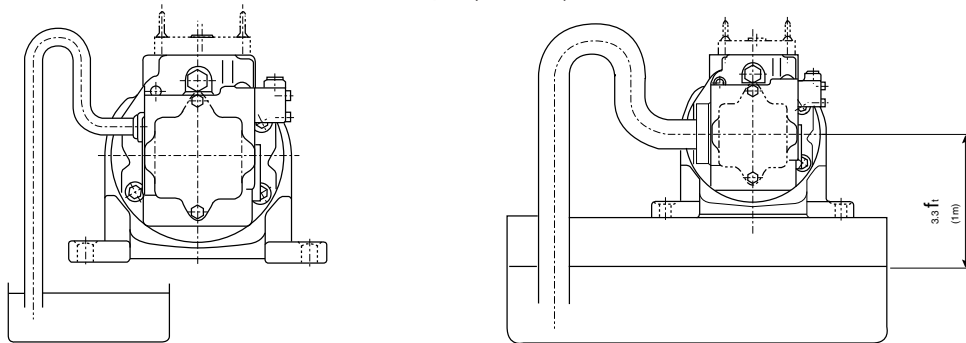

Mounting the pump vertically (shaft up)

For applications requiring vertical installation (shaft up) the pump must be provided with additional means to lubricate the front bearing. Do not use a standard pump for this type of application. (Mounting orientation “V” type should be used.)

The oil level in the tank should be higher than the pump mounting flange as shown in illustration [a] below. If the oil level in the tank is lower than the pump mounting flange then forced lubrication is required through the air bleed port (0.25 ~ 0.50 GPM [1 ~ 2 l/min]).

When installing the pump in the tank and submerged in the oil, open the drain port and air bleed port to provide adequate lubrication to the internal components.

When installing the pump outside the tank run piping for the drain and air bleed ports to tank (see illustration [c]). If the drain or air bleed piping rise above the level of oil (see illustration [b]) fill the lines with oil before operation.

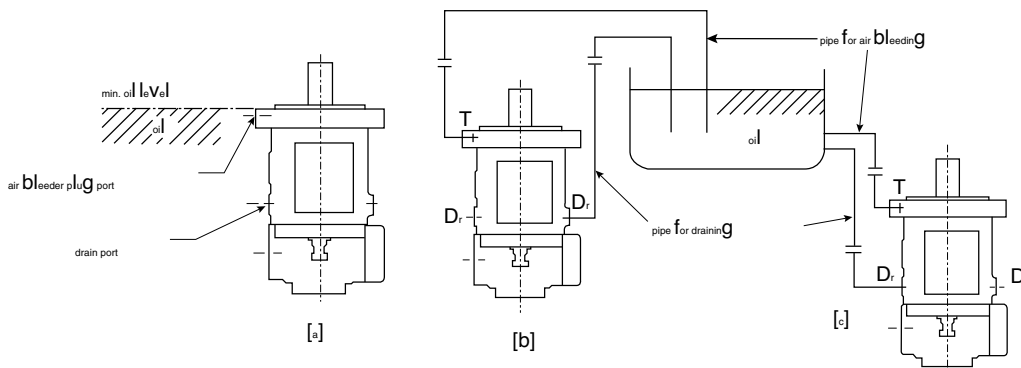

8 Filtration

For satisfactory service life for the K3VG pumps the oil should be continuously filtered to a minimum cleanliness level of 19/16/14 ISO/DIS 4406 (NAS Class 9).

At minimum a 10 μ filter should be installed in the return line and an 80 ~ 150 mesh strainer installed in the suction line.

9 Hydraulic Fluid Requirements

Use a high quality, anti-wear, mineral based hydraulic fluid when the pressure exceeds 3000 psi (207 bar). The viscosity must be between 10 cSt and 200 cSt for normal operation.

In applications where fire resistant fluids are required please consult Kawasaki for recommendations. The seals and ratings may need to be changed to ensure compatibility. The chart below illustrates the effects on pump life when using non-standard fluids.

Fluid type >>		mineral oil	phosphate ester	polyol ester	water glycol
Max pressure	psi (bar)	5075 (350)	3045 (210)	3045 (210)	3045 (210)
Temperature range	°F (°C)	68~140 (20~60)			50~112 (10~50)
Cavitation resistance		●	∅	∅	∅
Percentage pump life compared to mineral oil		100	60	50	20

● =optimum

∅=acceptable but with reduced pump life

10 Initial Start-Up

Make sure the pump case is filled with clean, filtered fluid of the type used in the system before operation. **When installing tandem pumps (K3VG180DT and K3VG280DT) make certain that both the front and rear pumps are filled with oil through both case drain ports.** The pump case must be full at all times to ensure proper lubrication of internal components.

11 Drive Shaft Coupling

Use a flexible coupling to connect the pump shaft to an engine flywheel or electric motor shaft. Alignment should be within 0.001 in (0.025 mm) parallel and 0.2° angular as shown in the illustration below.

Do not apply any radial or axial loading to the pump shaft. For applications where radial or side loads exist please contact Kawasaki for recommendations.

Do not hammer the coupling on or off the pump shaft. Use the threaded hole in the end of the pump shaft to fix or remove the coupling.

$$\text{dial gauge (reading a)}$$

$$\delta = a/2 \leq 0.001''$$

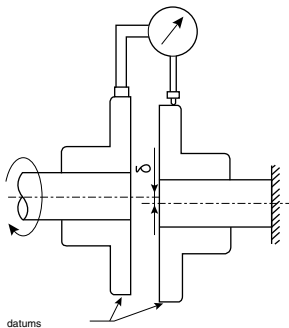

$$\text{dial gauge (reading b)}$$

$$\alpha = \sin^{-1} (b/D)$$

$$\leq 0.2^\circ$$

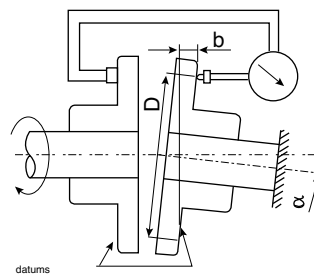

12 Installation Drawings

K3VG63/112/180/280 (WITHOUT ATTACHMENT)

The standard mounting type (mounting in the horizontal direction of shaft).
For the vertical mounting type, see the separate information.

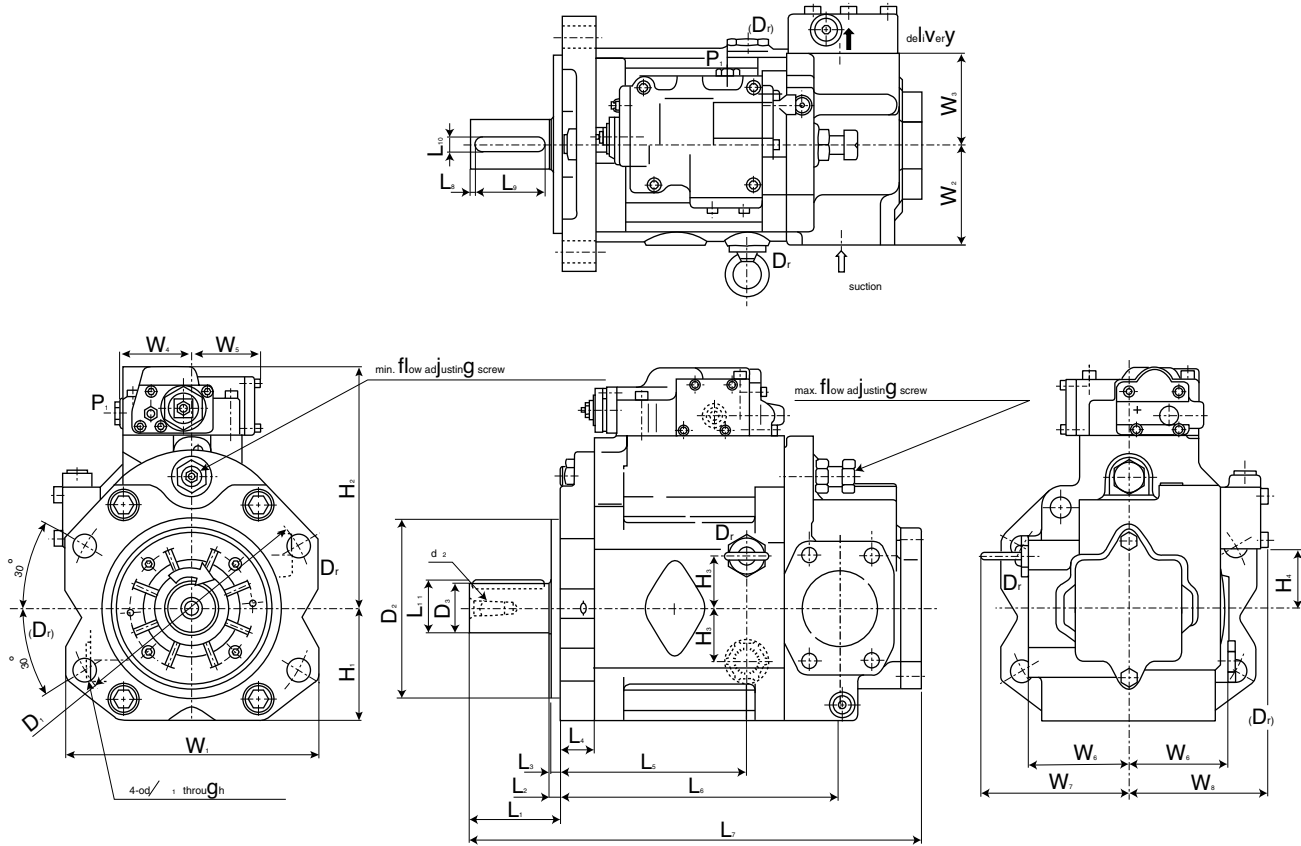

Dimensions of single pumps without gear pump - in (mm)

Pump size	D ₁	D ₂	D ₃	L ₁	L ₂	L ₃	L ₄	L ₅	L ₆	L ₇	L ₈	L ₉	L ₁₀	L ₁₁
63	7.09 (180)	4.92 ^{+0.002} _{-0.004} (125)	1.26 (32 ^{k6})	2.67 (68)	0.39 (10)	0.32 (8)	1.06 (27)	5.43 (138)	8.27 (210)	13.74 (349)	0.16 (4)	1.97 (50)	0.39 (10)	1.38 (35)
112	8.82 (224)	6.30 ^{+0.002} _{-0.004} (160)	1.55 (40 ^{k6})	3.62 (92)	0.39 (10)	0.32 (8)	1.30 (33)	6.57 (167)	9.80 (249)	16.50 (419)	0.20 (5)	2.76 (70)	0.47 (12)	1.69 (43)
180	9.84 (250)	7.09 ^{+0.002} _{-0.004} (180)	1.97 (50 ^{k6})	3.62 (92)	0.39 (10)	0.32 (8)	1.42 (36)	7.48 (190)	11.22 (285)	18.35 (466)	0.20 (5)	2.76 (70)	0.55 (14)	2.11 (53.5)
280	11.81 (300)	7.87 ^{+0.002} _{-0.004} (200)	2.17 (55 ^{k6})	3.62 (92)	0.39 (10)	0.35 (9)	1.97 (50)	7.99 (203)	13.82 (351)	21.22 (539)	0.20 (5)	2.76 (70)	0.63 (16)	2.32 (59)

Pump size	H ₁	H ₂	H ₃	H ₄	W ₁	W ₂	W ₃	W ₄	W ₅	W ₆	W ₇	W ₈	d ₁	d ₂
63	3.50 (89)	7.68 ^{+0.002} _{-0.004} (195)	1.46 (37)	1.61 (41)	7.48 (190)	2.76 (70)	2.76 (70)	2.83 (72)	2.72 (69)	2.99 (76)	4.53 (115)	4.45 (113)	0.71 (18)	M12
112	3.94 (100)	8.66 ^{+0.002} _{-0.004} (220)	1.61 (41)	1.93 (49)	9.21 (234)	3.54 (90)	3.15 (80)	2.83 (72)	2.72 (69)	3.54 (90)	5.43 (138)	4.92 (125)	0.87 (22)	M12
180	7.09 (112)	9.65 ^{+0.002} _{-0.004} (245)	2.09 (53)	2.28 (58)	10.08 (256)	3.94 (100)	3.62 (92)	2.83 (72)	2.72 (69)	3.98 (101)	5.87 (149)	5.47 (139)	0.87 (22)	M16
280	5.00 (127)	11.26 ^{+0.002} _{-0.004} (286)	2.76 (70)	2.68 (68)	11.81 (300)	4.72 (120)	4.72 (120)	2.83 (72)	2.72 (69)	4.65 (118)	—	6.57 (167)	1.02 (26)	M16

K3VG180DT/280DT (WITHOUT ATTACHMENTS)

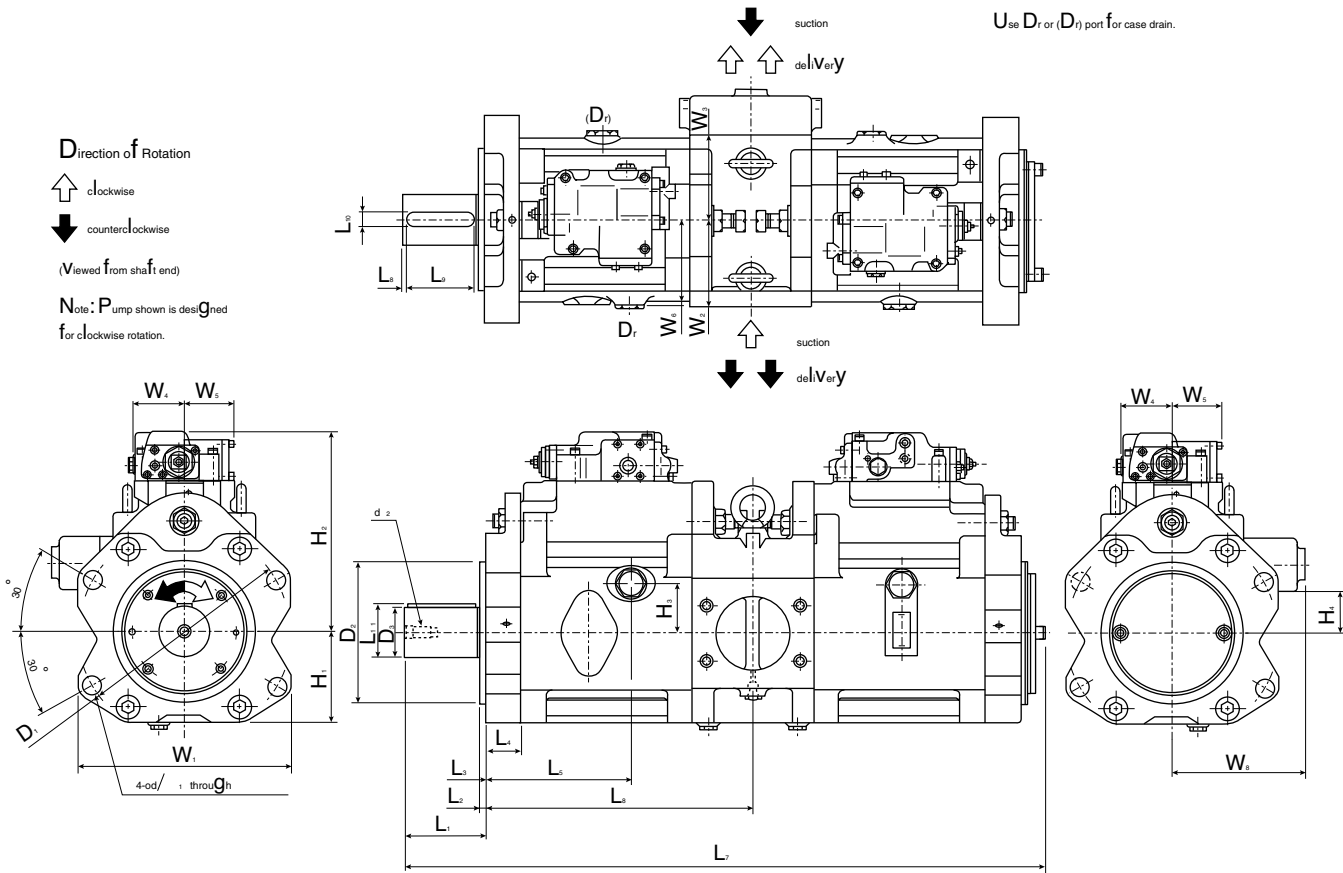

Dimensions of tandem pumps without gear pump - in (mm)

Pump size	D ₁	D ₂	D ₃	L ₁	L ₂	L ₃	L ₄	L ₅	L ₆	L ₇	L ₈	L ₉	L ₁₀	L ₁₁
180DT	9.84 (250)	7.09 ^{-0.002} _{-0.004} (180)	2.36 (60 ^{h6})	4.53 (115)	0.39 (10)	0.32 (8)	1.42 (36)	7.48 (190)	12.24 (311)	30.95 (786)	0.20 (5)	3.74 (95)	0.71 (18)	2.52 (64)
280DT	11.81 (300)	7.87 ^{-0.002} _{-0.004} (200)	2.76 (70 ^{h6})	4.53 (115)	0.39 (10)	0.35 (9)	1.97 (50)	7.99 (203)	14.72 (374)	35.28 (896)	0.20 (5)	3.74 (95)	0.79 (20)	2.93 (74.5)

Pump size	H ₁	H ₂	H ₃	H ₄	W ₁	W ₂	W ₃	W ₄	W ₅	W ₆	W ₈	d ₁	d ₂
180DT	7.09 (112)	9.65 (245)	2.09 (53)	2.01 (51)	10.08 (256)	3.94 (100)	3.94 (100)	2.83 (72)	2.72 (69)	3.98 (101)	6.50 (165)	0.87 (22)	M16
280DT	5.00 (127)	11.26 (286)	2.76 (70)	2.32 (59)	11.81 (300)	4.72 (120)	4.72 (120)	2.83 (72)	2.72 (69)	4.65 (118)	7.28 (185)	1.02 (26)	M16

DRAIN PORT

Dimensions of drain ports - in (mm)

Pump size	a	b	c	d
63	PF 1/2	0.890 (22.6)	0.098 (2.5)	0.75 (19)
112	PF 3/4	1.213 (30.8)	0.138 (3.5)	0.79 (20)
180, 180DT	PF 3/4	1.213 (30.8)	0.138 (3.5)	0.79 (20)
280, 280DT	PF 3/4	1.213 (30.8)	0.138 (3.5)	0.79 (20)

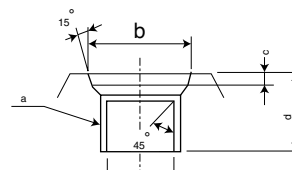

MOUNTING PROVISIONS FOR ATTACHING GEAR PUMPS

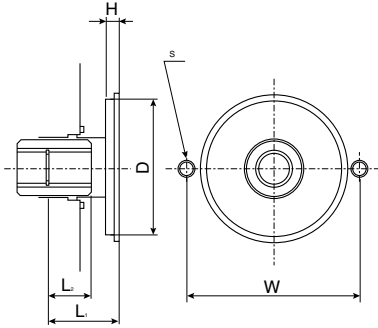

Size		63, 112, 180, 280				280, 180DT, 280DT
Install form code	Without assist pressure port	5	7	9	C	A
	With assist pressure port	4	6	8	D	
Dimensions (mm)	D	82.5				101.6
	H	8				11
	W	106				146
	S	2-M10 depth16				2-M12 depth20
	L ¹	34	43	37	34	43
	L ²	18	26	26	17	26
Dimensions of Spline(mm)	Rule	SAE flat root, side fit				
	Number of teeth	11	13	11	10	13
	Diametral pitch	16/32				
	Pressure angle	30°				
	Root diameter	19.05 ^{+0.279} ₀	22.225 ^{+0.279} ₀	19.05 ^{+0.279} ₀	17.463 ^{+0.279} ₀	22.225 ^{+0.279} ₀
	Measurements over pins	13.358 ⁰ _{-0.076}	16.589 ⁰ _{-0.067}	13.358 ⁰ _{-0.076}	11.887 ⁰ _{-0.084}	16.589 ⁰ _{-0.067}
	Pin diameter	2.743				
Allowable max. torque(lb-ft)	42.7	157.9	92	67.4	157.9	

FOOT BRACKET (ACCESSORY)

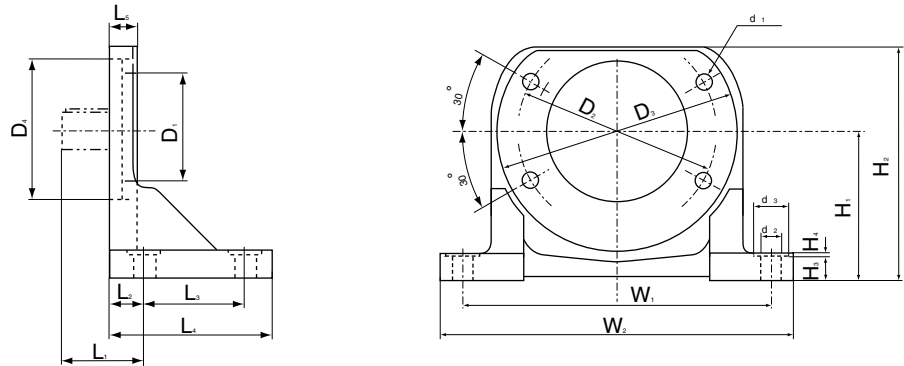

Dimensions of foot bracket - in (mm)

Pump size	D ₁	D ₂	D ₃	D ₄	L ₁	L ₂	L ₃	L ₄	L ₅	H ₁	H ₂	H ₃	H ₄	W ₁	W ₂	d ₁	d ₂	d ₃
63	4.92 (125)	7.09 (180)	8.43 (214)	—	2.95 (75)	1.26 (32)	3.66 (93)	5.91 (150)	0.98 (25)	5.20 (132)	8.15 (207)	0.87 (22)	0.12 (3)	11.02 (280)	12.60 (320)	M16	0.71 (18)	1.26 (32)
112	6.30 (160)	8.82 (224)	10.39 (264)	—	3.94 (100)	1.50 (38)	7.09 (112)	7.09 (180)	1.18 (30)	6.30 (160)	9.92 (252)	1.06 (27)	0.12 (3)	13.19 (335)	15.12 (384)	M20	0.87 (22)	1.58 (40)
180	7.09 (180)	9.84 (250)	11.42 (290)	—	3.94 (100)	1.73 (44)	5.20 (132)	8.35 (212)	1.65 (36)	7.09 (180)	11.18 (284)	1.30 (33)	0.12 (3)	14.76 (375)	16.85 (428)	M20	0.87 (22)	1.58 (40)
280	11.02 (200)	11.81 (300)	13.39 (340)	9.84 (250)	3.94 (100)	1.97 (50)	15.75 (400)	19.69 (500)	1.65 (42)	8.86 (225)	14.09 (358)	1.54 (39)	0.12 (3)	17.72 (450)	20.47 (520)	M24	1.34 (34)	2.36 (60)
180DT	7.09 (180)	9.84 (250)	11.42 (290)	8.03 (204)	4.84 (123)	1.73 (44)	12.60 (320)	15.75 (400)	1.65 (36)	11.02 (200)	11.97 (304)	1.30 (33)	0.12 (3)	14.76 (375)	16.85 (428)	M20	0.87 (22)	1.58 (40)
280DT	11.02 (200)	11.81 (300)	13.39 (340)	9.84 (250)	4.84 (123)	1.97 (50)	15.75 (400)	19.69 (500)	1.65 (42)	8.86 (225)	14.09 (358)	1.54 (39)	0.12 (3)	17.72 (450)	20.47 (520)	M24	1.34 (34)	2.36 (60)

FLANGE ACCESSORY FOR DELIVERY PORT (SAE CODE 62)

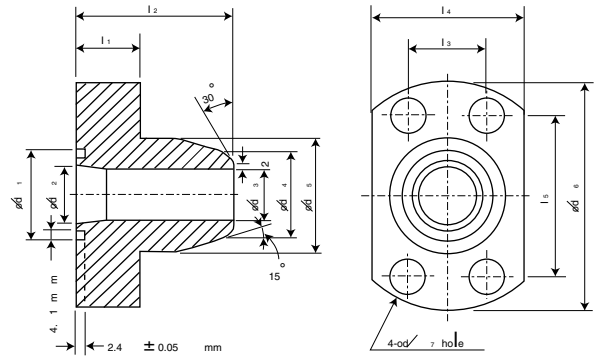

Delivery Port Flange - in (mm)

Pump size	l_1	l_2	l_3	l_4	l_5	d_1	d_2	d_3	d_4	d_5	d_6	d_7	SAE Pipe Size	Screw Size
63	0.98 (25)	2.17 (55)	1.095 (27.8)	2.13 (54)	2.252 (57.2)	1.58 (40)	1.02 (26)	0.835 (21.2)	1.339 (34.0)	1.693 (43)	3.23 (82)	0.43 (11)	1	M10-40
112	1.18 (30)	2.56 (65)	1.252 (31.8)	2.40 (61)	2.626 (66.7)	1.77 (45)	1.26 (32)	1.177 (29.9)	1.681 (42.7)	1.97 (50)	3.78 (96)	0.55 (14)	1 1/4	M12-45
180	1.38 (35)	2.95 (75)	1.437 (36.5)	2.76 (70)	3.126 (79.4)	1.97 (50)	1.50 (38)	1.354 (34.4)	1.913 (48.6)	2.28 (58)	4.53 (115)	0.71 (18)	1 1/2	M16-55
280	1.38 (35)	2.95 (75)	1.437 (36.5)	2.76 (70)	3.126 (79.4)	1.97 (50)	1.50 (38)	1.354 (34.4)	1.913 (48.6)	2.28 (58)	4.53 (115)	0.71 (18)	1 1/2	M16-55
180DT	1.18 (30)	2.56 (65)	1.252 (31.8)	2.40 (61)	2.626 (66.7)	1.77 (45)	1.26 (32)	1.177 (29.9)	1.681 (42.7)	1.97 (50)	3.78 (96)	0.55 (14)	1 1/4	M12-45
280DT	1.38 (35)	2.95 (75)	1.437 (36.5)	2.76 (70)	3.126 (79.4)	1.97 (50)	1.50 (38)	1.354 (34.4)	1.913 (48.6)	2.28 (58)	4.53 (115)	0.71 (18)	1 1/2	M16-55

When using confluence block - in (mm)

180DT	1.58 (40)	3.54 (90)	1.752 (44.5)	3.39 (86)	3.811 (96.8)	2.56 (65)	2.01 (51)	1.697 (43.1)	2.382 (60.5)	2.80 (71)	5.51 (140)	0.87 (22)	2	M20-65
280DT	1.58 (40)	3.54 (90)	1.752 (44.5)	3.39 (86)	3.811 (96.8)	2.56 (65)	2.01 (51)	1.697 (43.1)	2.382 (60.5)	2.80 (71)	5.51 (140)	0.87 (22)	2	M20-65

FLANGE ACCESSORY FOR SUCTION PORT (SAE CODE 61)

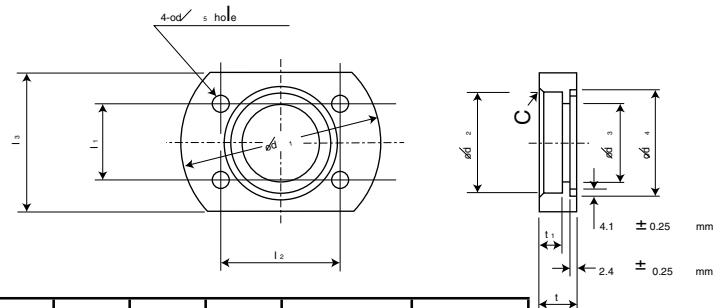

Suction Port Flange - in (mm)

Pump size	l_1	l_2	l_3	t	t_1	d_1	d_2	d_3	d_4	d_5	C	SAE Pipe Size	Screw Size
63	1.406 (35.7)	2.752 (69.9)	3.15 (80)	0.79 (20)	0.39 (10)	4.33 (110)	1.933 (49.1)	1.50 (38)	2.17 (55)	0.55 (14)	0.12 (3)	1 1/2	M12-35
112	2.000 (50.8)	3.500 (88.9)	4.13 (105)	0.98 (25)	0.59 (15)	5.12 (130)	3.031 (77.0)	2.52 (64)	3.15 (80)	0.55 (14)	0.12 (3)	2 1/2	M12-40
180	2.441 (62.0)	4.189 (106.4)	4.92 (125)	1.18 (30)	0.79 (20)	6.30 (160)	3.543 (90.0)	2.99 (76)	3.54 (90)	0.71 (18)	0.12 (3)	3	M16-50
280	2.752 (69.9)	4.752 (120.7)	5.32 (135)	1.18 (30)	—	6.69 (170)	3.543 (90.0)	3.54 (90)	4.13 (105)	0.71 (18)	0.16 (4)	3	M16-50
180DT	3.063 (77.8)	5.126 (130.2)	5.71 (145)	1.18 (30)	0.79 (20)	7.48 (190)	4.543 (115.4)	3.94 (100)	4.72 (120)	0.71 (18)	0.16 (4)	4	M16-50
280DT	3.063 (77.8)	5.126 (130.2)	5.71 (145)	1.18 (30)	0.79 (20)	7.48 (190)	4.543 (115.4)	3.94 (100)	4.72 (120)	0.71 (18)	0.16 (4)	4	M16-50



Kawasaki Precision Machinery (U.S.A.), Inc.

5080 36th Street S.E., Grand Rapids, MI 49512
(616) 949-6500 • Fax (616) 975-3103

www.kpm-usa.com